

myzox

PRODUCT COLLECTION
vol. **15**



A spider silk has over four times tougher than iron steel, higher stretching than that of a nylon, and over 300°C heat resistance.

To mimic this incredible functionality, many scientists over the world have investigated for many years.

In recent years, the world's first artificial spider silk has been developed by a Japanese company.

This material offers the possibility of improving on products from apparels to transport machineries to medical appliances to building materials.

We, Myzox deeply value the spirit which create something new and contribute to social development like this artificial spider silk.

We grasp how our market works and catch the needs as surely as a spider silk catches the prey.

We hope that our created products support your work.

GREETING

We would like to appreciate all our customers for dealing with us and are very glad to have a communication with newly touched people through this Product Collection. This is our new catalogue in 2018 and there are much more products than the last catalogue. Some products fit your market but some products might not match. However, we have lots more sourcings, so please feel free to contact us if there are no product which you are looking for on this catalogue.

We will take your opinion then develop the product to meet your market needs. Or we will show you the products from our other sourcings.

Our business will be built up by markets' voices and it is our mission to contribute to a development of society with our products. Having a gratitude for your contact, we hope we can make new values together with our customers.

GENERAL INFORMATION

Representative Hiroki Mizoguchi
Headquarter 401 Yamagoe Nagakute Aichi
480-1111 Japan
Establishment April in 1959
Branch office Tokyo, Osaka, Fukuoka, Sendai
Factories Japan, Taiwan, China, Vietnam

HISTORY

- 1950 Become independent as a Mizoguchi Woodworking Plant from a branch plant of Kotobukiya Woodwork.
- 1953 Renamed to Mizoguchi Manufacturing Company.
- 1954 Meter-manufacturing-license acquired from the Minister of International Trade and Industry.
- 1959 Mizoguchi Manufacturing Co., Ltd. was established.
- 1960 Tokyo branch office was opened in Shinjuku, Tokyo.
- 1971 The factory was newly built and relocated to Seto-shi, Aichi.
- 1978 The Overseas Marketing Department was started.
- 1983 Headquarters office was newly built and relocated to Nagakute-cho, Aichi.
Six companies of venture capitals carried out capital participation. The capital was increased to 150 million yen.
- 1985 The Technological Development Center was started.
- 1990 Company name was changed to Myzox Co., Ltd.
- 1991 Production in China was started.
- 1993 Sales of the self-developed Surveying CAD System was started.
- 1994 Production in Taiwan was started.
- 1997 Myzox Creative Co., Ltd. was established.
Myzox Solution Co., Ltd. was established.
- 1999 Accreditation of ISO9001 Quality System Certification was acquired.
- 2001 Support Center was opened.
- 2002 Fukuoka Office was opened.
- 2004 Myzox Kunshan Co., Ltd. was established in China.
- 2006 Osaka Office was opened
- 2007 Myzox Solution Co.,Ltd. and Myzox Creative Co.,Ltd. merged with Myzox. Co. Ltd.
- 2008 Tohoku Liaison office was opened.
- 2012 Solar electric generation was installed.
Online store was opened.
- 2013 Production in Vietnam was started.
CS Center (New Factory in Japan) was newly built.
- 2018 Drone solution division was started.



TRIPOD ▶ P.017	<input type="checkbox"/> Aluminium Tripod <input type="checkbox"/> Wooden Tripod <input type="checkbox"/> GNSS Tripod <input type="checkbox"/> Bipod <input type="checkbox"/> Elevating Tripod <input type="checkbox"/> Prism Pole Tripod <input type="checkbox"/> Laser Tripod <input type="checkbox"/> Tripod Accessory	TRIPOD 1
PRISM ▶ P.029	<input type="checkbox"/> 220°Prism <input type="checkbox"/> 0.7 inch Prism <input type="checkbox"/> 1.0 inch Prism <input type="checkbox"/> 1.5 inch Prism <input type="checkbox"/> DM Pin Pole <input type="checkbox"/> 2.5 inch Prism <input type="checkbox"/> Tribrach <input type="checkbox"/> Prism Adapter <input type="checkbox"/> Prism <input type="checkbox"/> Prism Pole <input type="checkbox"/> Monitoring Prism <input type="checkbox"/> LED Flashing Prism <input type="checkbox"/> Prism Sheet	PRISM 2
POLE ▶ P.045	<input type="checkbox"/> DM Pin Pole Colorfast type <input type="checkbox"/> DM Pin Pole <input type="checkbox"/> Pin Pole Shoe <input type="checkbox"/> Pole Accessory <input type="checkbox"/> Prism Pole Tripod <input type="checkbox"/> Prism Adapter <input type="checkbox"/> Prism Pole <input type="checkbox"/> Circular Level <input type="checkbox"/> Carbonfiber Pole <input type="checkbox"/> Bipod <input type="checkbox"/> GNSS Pole <input type="checkbox"/> Surveying Pole <input type="checkbox"/> Pole Stand <input type="checkbox"/> Fiberglass Measuring Pole	POLE 3
STAFF ▶ P.059	<input type="checkbox"/> Aluminium Staff <input type="checkbox"/> Prism Staff <input type="checkbox"/> Fiberglass Precision Staff <input type="checkbox"/> Fiberglass Staff <input type="checkbox"/> Drain Staff <input type="checkbox"/> Scale Staff <input type="checkbox"/> Bipod for Staff <input type="checkbox"/> Staff Accessory <input type="checkbox"/> Circular Level <input type="checkbox"/> Display Stand <input type="checkbox"/> Photo Record Accessory	STAFF 4
GNSS ACCESSORY ▶ P.073	<input type="checkbox"/> Carbonfiber Pole <input type="checkbox"/> Bipod <input type="checkbox"/> Clamp Holder for Smart Device <input type="checkbox"/> GNSS Receiver Case <input type="checkbox"/> Tribrach <input type="checkbox"/> Adapter <input type="checkbox"/> GNSS Pole	GNSS ACCESSORY 5
SURVEYING / LASER INSTRUMENT ▶ P.081	<input type="checkbox"/> Automatic Level <input type="checkbox"/> Digital Theodolite <input type="checkbox"/> Green Line Laser <input type="checkbox"/> Red Line Laser <input type="checkbox"/> Line-Laser Tripod <input type="checkbox"/> Detector <input type="checkbox"/> Rotating Laser <input type="checkbox"/> Elevating Tripod <input type="checkbox"/> Scale Staff <input type="checkbox"/> Laser Accessory	SURVEYING / LASER INSTRUMENT 6
SURVEYING ACCESSORY ▶ P.093	<input type="checkbox"/> Backpack for Total Station <input type="checkbox"/> Surveying Nail & Marker <input type="checkbox"/> Plane Table <input type="checkbox"/> Plumb bob <input type="checkbox"/> Stereoscope <input type="checkbox"/> Pocket Compass <input type="checkbox"/> Clinometer <input type="checkbox"/> Compass <input type="checkbox"/> Surveying Peg <input type="checkbox"/> Survey Bag <input type="checkbox"/> Hand Level <input type="checkbox"/> Field Book <input type="checkbox"/> Binocular <input type="checkbox"/> Marking Template <input type="checkbox"/> Vertex Laser <input type="checkbox"/> Surveying Umbrella <input type="checkbox"/> Lightning Detector <input type="checkbox"/> Ground Control Point <input type="checkbox"/> Anemometer	SURVEYING ACCESSORY 7
MEASURING TOOL ▶ P.105	<input type="checkbox"/> Nylon Coated Steel Tape <input type="checkbox"/> Fiberglass Tape <input type="checkbox"/> Pocket Measuring Tape <input type="checkbox"/> Non Conductive Measuring Tape <input type="checkbox"/> Pocket Rod <input type="checkbox"/> Measuring Tape <input type="checkbox"/> Diameter Tape <input type="checkbox"/> Caliper <input type="checkbox"/> Surveyor's Rope <input type="checkbox"/> Measuring Wheel <input type="checkbox"/> Chalk Liner <input type="checkbox"/> Laser Rangefinder <input type="checkbox"/> Tally Counter <input type="checkbox"/> Stopwatch <input type="checkbox"/> Curvimeter <input type="checkbox"/> Planimeter <input type="checkbox"/> Laser Plumb Bob <input type="checkbox"/> Angle Level <input type="checkbox"/> Spirit Level <input type="checkbox"/> Slant Rule <input type="checkbox"/> Water Level Meter <input type="checkbox"/> Water Depth Meter <input type="checkbox"/> Stream Gauge	MEASURING TOOL 8
TESTING INSTRUMENT ▶ P.123	<input type="checkbox"/> Thermometer <input type="checkbox"/> Thermo-Hygrometer <input type="checkbox"/> Environment Meter <input type="checkbox"/> Barometer <input type="checkbox"/> Altimeter <input type="checkbox"/> Anemometer <input type="checkbox"/> Moisture Meter <input type="checkbox"/> Current Meter <input type="checkbox"/> Coating Thickness Gauge <input type="checkbox"/> Clamp Meter <input type="checkbox"/> Sound Meter <input type="checkbox"/> pH Meter <input type="checkbox"/> Test Hammer <input type="checkbox"/> Test Anvil <input type="checkbox"/> Rock Hammer <input type="checkbox"/> Slump Test <input type="checkbox"/> Screen <input type="checkbox"/> Air Meter <input type="checkbox"/> Crack Scale <input type="checkbox"/> Soil Moisture Meter <input type="checkbox"/> Inspection Hammer <input type="checkbox"/> Scale <input type="checkbox"/> Magnifier	TESTING INSTRUMENT 9
SECURITY GOODS ▶ P.137	<input type="checkbox"/> Hard Hat <input type="checkbox"/> Safety Vest <input type="checkbox"/> Safety Belt <input type="checkbox"/> Gloves <input type="checkbox"/> Glasses <input type="checkbox"/> Safety Shoes <input type="checkbox"/> Working Wear <input type="checkbox"/> Head Light <input type="checkbox"/> LED Torch <input type="checkbox"/> Inspection Camera <input type="checkbox"/> Safety Cone <input type="checkbox"/> Barricade Tape	SECURITY GOODS 10

INDEX Product Name [A-Z]

1	TRIPOD	No.	0.7 inch Compact Prism	032		
		0.7 inch Stick Prism	033			
		0.7 inch Strap Prism	032			
		1.0 inch Prism	034			
		1.0 inch Prism 0mm / 30mm constant	033			
		1.0 inch Prism Corner use	034			
		1.5 inch Prism	035			
		1.5 inch Prism 0mm / 30mm constant	035			
		2.5 inch Monitoring Base Kit	041			
		2.5 inch Prism	037 • 038			
2	PRISM	2.5 inch Triple Prism	038			
		2.5 inch Prism Soft Case	043			
		A	Abney Hand Level	101		
			Adapter for GNSS Receiver	079		
			Air Conditioned Working Wear	143		
			Air Flow Meter	104 • 129		
			Air Meter	134		
			Alidade	097		
			Altimeter	127 • 128		
			Aluminium Display Stand	070		
Aluminium Photo Rod	071					
Aluminium Photo Rod Set	071					
3	POLE	Aluminium Ranging Pole	056			
		Aluminium Staff Economical type	063			
		Aluminium Staff Heavy-duty type	062			
		Aluminium Staff Less Section type	064			
		Aluminium Staff Long type	066			
		Aluminium Staff Quality type	061			
		Aluminium Staff Slim type	064			
		Aluminium Staff Standard type	062			
		Aluminium Staff Wide type	063			
		Aluminium Tripod	020 • 021 • 022 • 023 • 025 • 026 • 092			
4	STAFF	Aluminium Tripod Round Leg	020 • 022 • 023			
		Aluminium Tripod Square Leg	021			
		Anemometer	104 • 129			
		Angle Level	118 • 119 • 120			
		Anvil	132 • 133			
		Artificial Leather Gloves	142			
		Automatic Level	082 • 083			
		Automatic Rotating Laser	091			
		5	GNSS ACCESSORY	B	Backpack	101
				Backpack for Total Station	094	
Bag for Piles	101					
Barometer	128					
Barometric Altimeter with Compass	128					
Barricade Rope	145					
Barricade Tape	145					
Binocular	102					
Bipod	025 • 054 • 075					
Bipod Case	054 • 075					
6	SURVEYING / LASER INSTRUMENT	Bipod for Staves	069			
		Bipod Shoe	054 • 075			
		Bracket	035 • 041 043 • 044			
		Bracket for Controller	076			
		Bracket for Smartphone	076			
		Bracket for Tablet	077			
		Brunton type Compass	099			
		Bubble	052 • 070 • 098			
		Button	069			
		Button Protection Label	069			
7	SURVEYING ACCESSORY	C	Caliper for Wooden Diameter	110		
		Carbonfiber Pole	053 • 054 • 074 • 075			
		Carbonfiber Pole Case	053 • 074			
		Case for Bipod	054 • 075			
		Case for Carbonfiber Pole	053 • 074			
		Case for Carbonfiber Pole & Bipod	054 • 075			
		Case for GNSS Accessory	078			
		Chalk Liner	113			
		Chalk Powder for Liner	113			
		Chisel Hammer	136			
8	MEASURING TOOL	Circular Level for Pole	052			
		Circular Level for Staff	070			
		Circumference Tape	110			
		Clamp Meter	131			
		Clinometer	099			
		Coating Thickness Gauge	130			
		Compact Altimeter	128			
		Compact Prism	032 • 033 • 034 • 035			
		Compact Thermometer	126			
		Compass	099 • 100			
9	TESTING INSTRUMENT	Compass Eyeglass type	100			
		Concrete Test Hammer	132 • 133			
		Concrete Test Hammer with Test Anvil	133			
		Controller Bracket	076			
		Crack Depth Scale	135			
		Crack Disc	135			
		Crack Gauge	135			
		Crack Scale	135			
		Current Meter	130			
		Curvimeter	115			
10	SECURITY GOODS	D	Degrinatoire	097		
		Detector	085 • 086 • 087 • 088 • 089 • 090 • 091			
		Diameter Tape	110			
		Digital Angle Level	118 • 119 • 120			
		Digital Crack Meter	135			
		Digital Curvimeter	115			
		Digital Max. and Min. Thermometer	126			
		Digital Moisture Meter	130			
		Digital Sound Level Meter	131			
		Digital Tally Counter	114			
Digital Theodolite	084					
Digital Thermo Hygrometer	126					
Digital Waterproof Thermometer	124					
Display Stand	070					
Distance Measuring Wheel	112					
DM Pin Pole	032 • 036 • 047					
DM Pin Pole 6mmφ	048 • 076					
DM Pin Pole Colorfast type	036 • 046					
0	TRIPOD	Drain Staff	068			
		Drone	014 • 015			
		Drone Marker	104			
		E	Eco Tape Rod	072		
		Electronic Automatic Green Line Laser	085			
		Elevating Tripod	026 • 092			
		Elevating Tripod for Laser	028 • 085 • 086 • 090			
		Endoscope	144			
		Environmental Meter	127 • 129			
		F	Fan for Hard Hat	139		
Fiberglass Measuring Pole	057 • 058					
Fiberglass Precision Staff	066					
Fiberglass Staff Hexagonal Shape	067					
Fiberglass Staff Oval Shape	067					
Fiberglass Surveyor's Rope	111					
Fiberglass Tape	107					
Fiberglass Wooden Tripod	025					
Field Book	102					
Flashing Light for Safety Cone	145					
Flexible Clamp Meter	131					
G	Glow Leveling Line	113				
GNSS Aluminium Tripod	025					
GNSS Receiver Adapter	079					
GNSS Receiver Case	078					
GNSS Receiver Pole	055 • 080					
Green Line Laser	087					
Ground Control Point	104					
Ground Plate	069					
H	Hand Level	101				
Hand Light	144					
Hand Magnifier	136					
Hard Hat	138 • 139					
Head Light	143					
Height Measuring Gauge	103					
Helmet	138 • 139					
Holder for Laptop	077					
Holder for Smartphone	077					
Hygrometer	126					
Infrared Radiation Thermometer	125					
I	Inspection Camera	144				
K	KATANA	015				
L	Laptop Holder	077				
Laser Mount	092					
Laser Plumb Bob	117					
Laser Rangefinder	114					
Laser Receiver	085 • 086 • 087 • 088 • 089 • 090 • 091					
LED Flashing Prism Target	041					
LED Head Light	143					
LED Safety Vest	140					
LED Torch	144					
Level Book	102					
Leveling Adapter	092					
Leveling Line	113					
Lightning Detector	103					
Line Laser	085 • 086 • 087 • 088 • 089					
Line Laser Detectors	090					

M	Loupe	136
	Luminous Angle Level	120
	Magnetic Joint for Photo Rod	072
	Magnifier	136
	Measuring Pole	057 • 058
	Measuring Probe for Plane Table	097
	Measuring Staff	068 • 092
	Measuring Tape	106 • 107 • 108
	Measuring Tape for Depth	109
	Measuring Wheel	112
	Mesh Safety Vest	140
	Metal Alidade	097
	Mini Prism	032 • 033 • 034 • 035
	Mini Prism Adapter	035 • 039 • 040 • 044 • 049 • 078 • 079
	Moisture Meter	130 • 136
	Monitoring Prism	041 • 042 • 043
	Mount Base	077
	Multi Line Laser	085 • 089
	Multifunction Altimeter	127
	Multifunction Anemometer	129
	Multifunction Environmental Meter	127
	Multifunctional Environmental Meter	127
N	Non Conductive Measuring Tape	109
	Nylon Coated Steel Tape	106
O	Optical Square	097
P	Peg	100
	pH Meter	131
	Pick Hammer	136
	Pin Pole	032 • 036 • 046 • 047 • 048 • 076
	Pin Pole Case	036 • 046 • 047
	Pin Pole Shoe	032 • 036 • 039 • 046 • 047 • 048 • 049 • 050 • 078
	Plane Table Set	097
	Planimeter	116 • 117
	Plastic Surveying Peg	100
	Plumb Bob	043 • 098 • 117
	Plumbing Arm	097
	PM2.5 Air Monitor	131
	Pocket Compass	098
	Pocket Measuring Tape	108 • 109
	Pocket pH Meter	131
	Pocket Rod	109
	Pocket Stereoscope	098
	Pole Case	036 • 046 • 047 • 050 • 051
	Pole Stand	056
	Portable Barricade Tape	145
	Precision Wooden Tripod	024
	Prism Accessory	035 • 039 • 040 • 041 • 043 • 044 • 049 • 078 • 079

	Prism Adapter	043
	Prism Canister	040
	Prism Case	031 • 032 • 033 • 034 • 035 • 043 • 048
	Prism Cushion Case	043 • 048
	Prism Pole	032 • 036 • 046 • 047 • 048 • 050 • 051 • 076
	Prism Pole 2.6 Meter	040 • 052
	Prism Pole Shoe	050 • 051
	Prism Pole Tripod	027 • 049
	Prism Protector	035
	Prism Sheet	043
	Prism Staff	065
	Prism Tripod	032
	Prism with Holder	040
	Protection Cap	138 • 139
	Protection Label	069
R	Rain Cover for RC-25	041
	Rain Cover for M-RBP2	094
	Rangefinder	114
	Ranging Pole	056
	Real Green Line Laser	086
	Rebar Photo Marker	070
	Red Line Laser	088 • 089
	Reflective Caution Rope	145
	Retractable Staff	109
	Rock Hammer	133
	Rod Stand	072
	Rope Reel for Surveyor's Rope	111
	Rotating Laser	091
S	Safety Belt	141
	Safety Full Body Harness	141
	Safety Glasses	142
	Safety Gloves	142
	Safety Shoes	142
	Safety Vest	140
	Scale	136
	Scale Staff	068 • 092
	Screen for Asphalt	134
	Screen for Concrete	134
	Seamless Backpack	101
	Shoe for Bipod	054 • 075
	Shoe for Carbonfiber Pole	053 • 074
	Shoe for Pin Pole	032 • 036 • 039 • 046 • 047 • 048 • 049 • 050 • 078
	Shoe for Pole	050 • 051
	Short Aluminium Tripod Round Leg	022
	Short Aluminium Tripod Square Leg	023
	Silva Compass	100
	Sinker for Surveyor's Rope	111
	Slant Rule	120
	Slip Stopper	028
	Slope Level	118 • 119 • 120
	Slump Test Apparatus	134
	Smartphone Bracket for DM Pin Pole	076
	Soil Moisture Meter	136

	Sound Level Meter	131
	Spigot type Pole Adapter	039 • 049 • 078
	Spirit Level	120
	Staff Bipod	069
	Staff Button	069
	Staff Case	069
	Stainless Tape	106
	Stencil Plate	102
	Stereoscope	098
	Stopwatch	115
	Stream Gauge	122
	Survey Pole	056
	Survey Wall Point Plug	041
	Surveying Nail	096
	Surveying Nail & Marker	095 • 096
	Surveying Umbrella	103
	Surveyor's Wire Rope	111
	Surveyor's Rope	111
	Surveyor's Rope Reel	111
T	Tablet Holder	077
	Tally Counter	114
	Tape Rod	072
	Test Anvil	132 • 133
	Test Hammer	132 • 133
	Theodolite	084
	Thermo-Hygrometer	126
	Thermometer	124 • 125 • 126
	Thermometer for Asphalt	125
	Thunder Detector	103
	Torch	144
	Traffic Cone	145
	Tribrach	039 • 078
	Tribrach & Height Adapter	039 • 079
	Tribrach Adapter	079
	Tribrach with Optical Plummet	039 • 078
	Tripod Case	027 • 028
	Tripod Chain	028
	Tripod for Pocket Compass	098
	Tripod Slip Stopper	028
	Tubular Level for Plane Table	098
U	UAV	014 • 015
	UAV Marker	104
	Umbrella	103
	USB LED Torch	144
V	Ventless Goggles	142
W	Wall Mount	092
	Water Depth Meter	121
	Water Level Meter	121 • 122
	Waterproof Digital Angle Level	119
	Waterproof Mini Scale	136
	Weight for Traffic Cone	145
	Wide Angle Reflecting Target	031
	Wooden Surveying Peg	100
	Wooden Tripod	024 • 025
X	X grip for Smartphone	077
Y	YOROI	014
Z	ZERO220	031

TRIPOD
PRISM
POLE
STAFF
GNSS ACCESSORY
SURVEYING / LASER INSTRUMENT
SURVEYING ACCESSORY
MEASURING TOOL
TESTING INSTRUMENT
SECURITY GOODS

1
2
3
4
5
6
7
8
9
10

WHERE TO USE

Surveying Site

We will introduce Japanese surveying with illustrations.
For product details, please check the page of your interesting product.

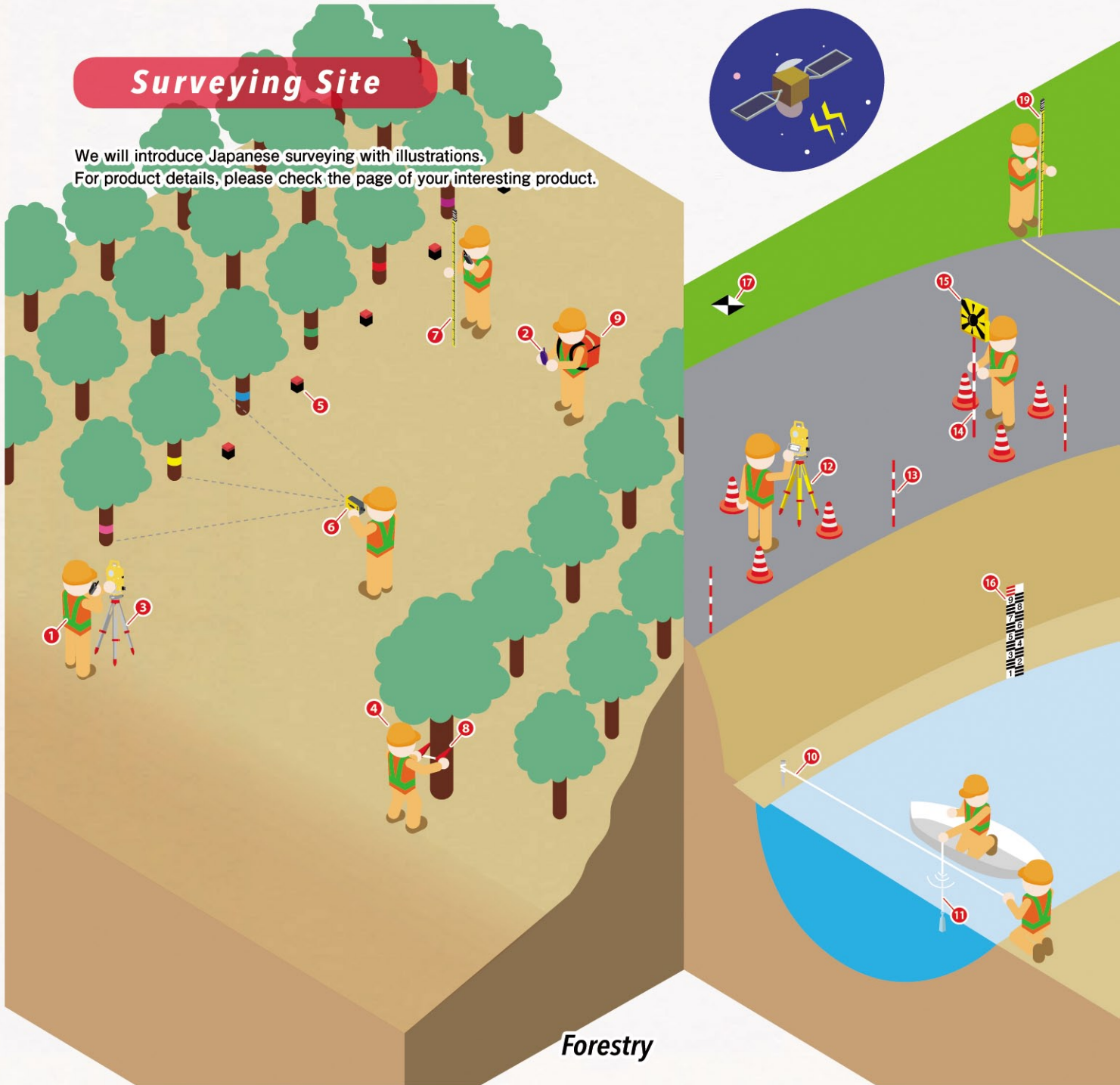
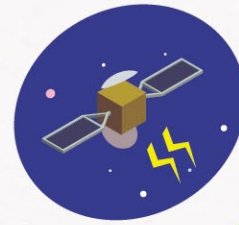

Forestry

1 Safety Vest  P.140	3 Aluminium Tripod  P.020	5 Wooden Surveying Peg  P.100	7 Prism Staff  P.065	9 Backpack for Total Stations  P.094	11 Water Depth Meter  P.121	13 Aluminium Ranging Pole  P.056
2 Altimeter  P.128	4 Hard Hat  P.138	6 Laser Rangefinder  P.114	8 Calliper for Wooden Diameter  P.110	10 Surveyor's Rope  P.111	12 Precision Wooden Tripod  P.024	14 Prism Pole  P.040

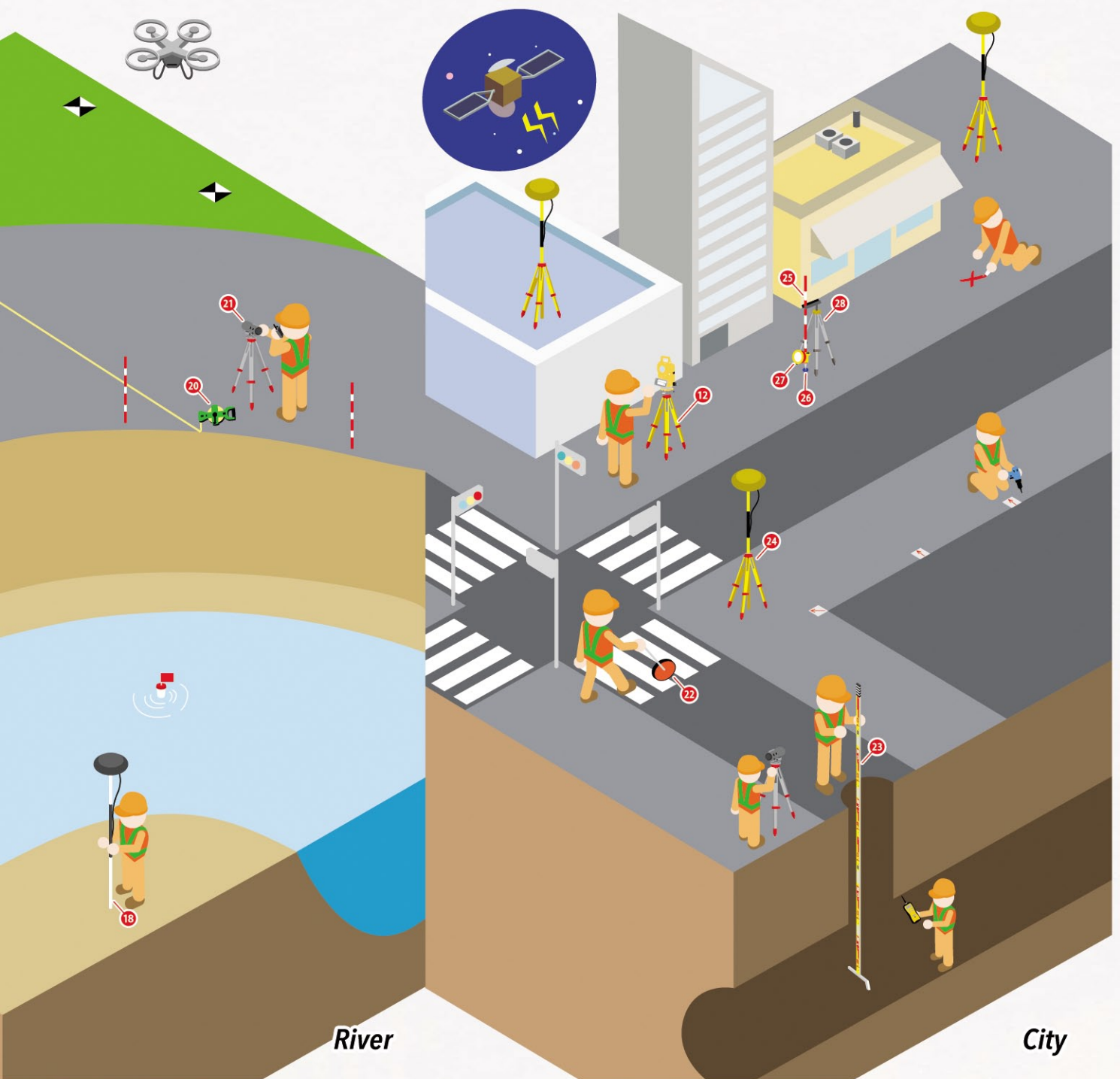

River

City

TRIPOD 1

PRISM 2

POLE 3

STAFF 4

GNSS ACCESSORY 5

SURVEYING / LASER INSTRUMENT 6

SURVEYING ACCESSORY 7

MEASURING TOOL 8

TESTING INSTRUMENT 9

SECURITY GOODS 10

15 2.5 inch Prism



P.037

17 Ground Control Point



P.104

19 Aluminium Staff



P.061

21 Automatic Level



P.082

23 Drain Staff



P.068

25 DM Pin Pole



P.036

27 1.5 inch Prism Dual Lock



P.035

16 Stream Gauge



P.122

18 Carbonfiber Pole



P.053

20 Nylon Coated Steel Tape



P.106

22 Measuring Wheel



P.112

24 GNSS Receiver Pole



P.080

26 Surveying Nail & Marker



P.095

28 Prism Pole Tripod



P.027

WHERE TO USE

Construction Site

We will introduce Japanese construction with illustrations.
For product details, please check the page of your interesting product.



1 Safety Vest



P.140

3 Automatic Rotating Laser



P.091

5 Automatic Level



P.082

7 Nylon Coated Steel Tape



P.106

9 Digital Angle Level



P.118

2 Aluminium Staff



P.061

4 Scale Staff



P.068

6 Aluminium Tripod Round Leg



P.020

8 Concrete Test Hammer



P.133

10 Line Laser



P.086

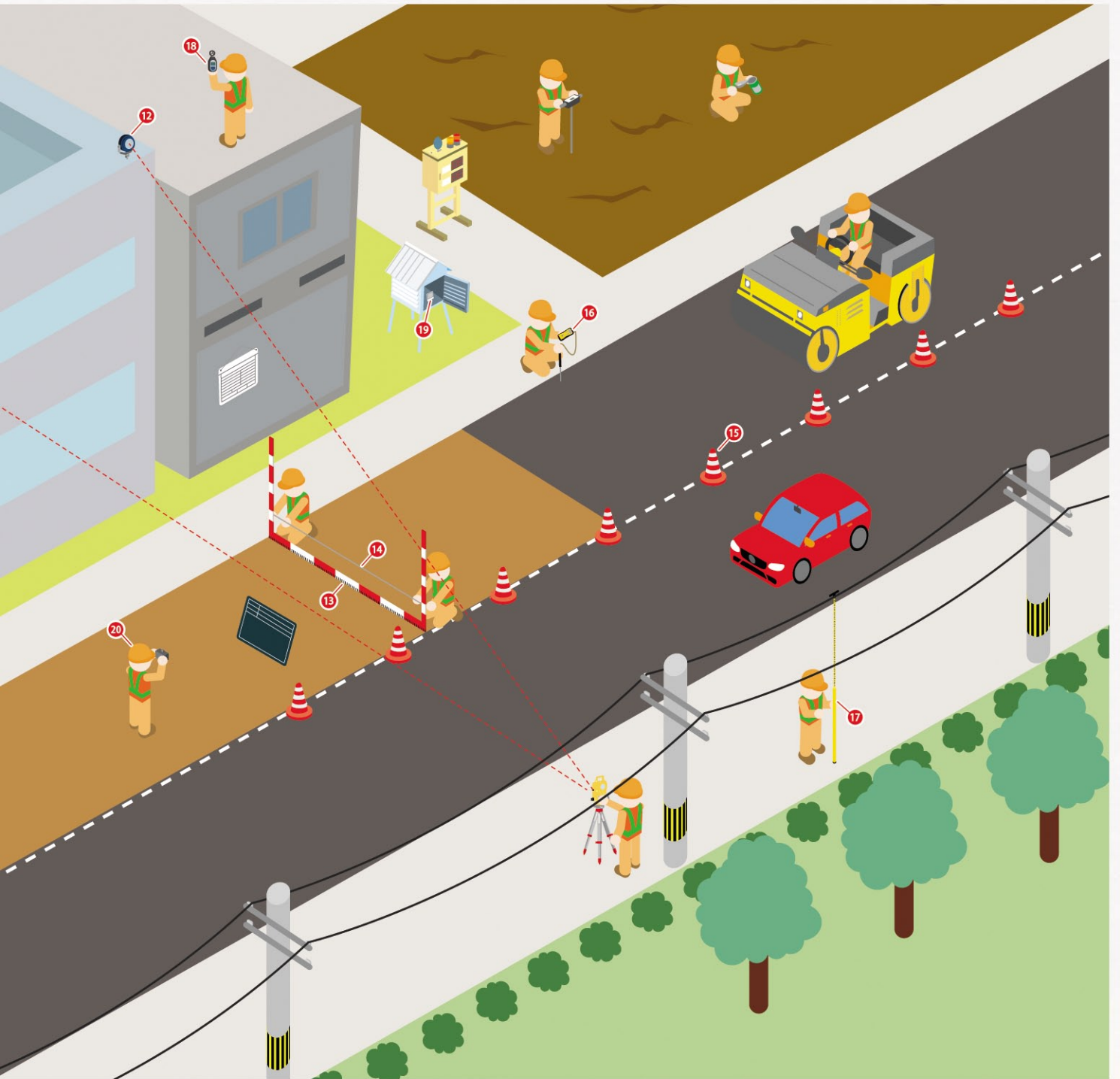

TRIPOD	1
PRISM	2
POLE	3
STAFF	4
GNSS ACCESSORY	5
SURVEYING / LASER INSTRUMENT	6
SURVEYING ACCESSORY	7
MEASURING TOOL	8
TESTING INSTRUMENT	9
SECURITY GOODS	10

11 Prism Sheet

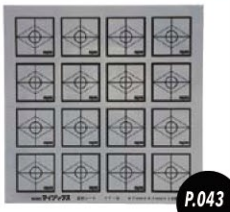

13 Aluminium Photo Rod



15 Safety Cone



17 Auto-counted Fiberglass Measuring Pole



19 Digital Max. and Min. Thermometer



12 Monitoring Prism



14 Glow Leveling Line



16 Digital Waterproof Thermometer



18 Anemometer



20 Hard Hat





New Products

The following products are a part of new products. Each chapter has some new products, please check them and promote in your market.

*New products are introduced by NEW

REDESIGNED

Precision Wooden Tripod
PMW series



▶ P.024

COMPACT

220° Prism
ZERO220 series



▶ P.031

RELOCATABLE

Survey Wall Point Plug
SPP-40



▶ P.041

FOR OILY SURFACE

Monitoring Prism
TT-0M



▶ P.042

HIGH MOBILITY

Aluminium Staff
ALG-25Y



▶ P.062

SMARTPHONE MOUNT

Smartphone Bracket for DM Pin Pole
DM-SH6



▶ P.076

TABLET MOUNT

Tablet Holder
RAM-HOL-TAB



▶ P.077

BRIGHT MULTI LINES

Electronic Automatic Green Line Laser
G-440S



▶ P.085

DIGITAL READOUT

Digital Laser Ditector
D-RE



▶ P.091

1 TRIPOD
2 PRISM
3 POLE
4 STAFF
5 GNSS ACCESSORY
6 SURVEYING / LASER INSTRUMENT
7 SURVEYING ACCESSORY
8 MEASURING TOOL
9 TESTING INSTRUMENT
10 SECURITY GOODS

COMPACT

Backpack for Total Station
M-RBPS



P.094

FOR YOUR SAFETY

Lightning Detector
NTD-P01



P.103

BEFORE DRONE FLYING

Digital Anemometer
DAM-30



P.104

WALK TO MEASURE

Measuring Wheel
MG series



P.112

DIRECT READING

Digital Angle Level
DGL-3D



P.118

WOOD DRYNESS

Moisture Meter
HT-20



P.130

ATOMOSPHERIC POLLUTION

PM2.5 Air Monitor
TH-A1 series



P.131

MINERAL SURVEY

Hand Magnifier
IWAMOTO



P.136

FOR YOUR SAFETY

Safety Vest
5920010 series



P.140

TOUCHSCREEN CONTROLABLE

Gloves
PU Smart



P.142

DURABLE FASTENER

Safety Shoes
Magical Forester



P.142

COOL IN THE SUN

Air Conditioned Working Wear
BR series



P.143

TRIPOD 1
PRISM 2
POLE 3
STAFF 4
GNSS ACCESSORY 5
SURVEYING / LASER INSTRUMENT 6
SURVEYING ACCESSORY 7
MEASURING TOOL 8
TESTING INSTRUMENT 9
SECURITY GOODS 10

HOW TO READ

The products are introduced by following items.

*Right image is different from actual contents.

- 1 Product Name
- 2 Model
- 3 Product Feature
- 4 New Product Mark
- 5 QR Code
QR Code can be read by an imaging device such as a mobile phone, scanner, etc. You can get more details or movie.

Easy to read Composition

The composition is standardized to get the information easily.

- 6 Product Name
This is a name of product.
- 7 Model
This is a unique name of product.
- 8 Package Quantity
This is a quantity in one box.
- 9 Minimum Order Quantity
Please order this quantity.
- 10 Code Number
We recommend you to order with code number to avoid a mistaken order.
- 11 Country of Origin
The country is manufactured.

NEW 1.5 inch Prism Dual Lock
MG-1500GP2

DUAL LOCK
Screw Lock and Quick Lock.



38mmφ





Dual lock
(Screw / Quick)



Circular level
(40' / 2mm)



Easy-to-adjust
screw for level

SPECIFICATIONS

Prism size : 1.5inch (38mm)
Prism constant : 0mm
Beam deviation : 2" - 3"
Prism coating : Silver
Size : 81 x 72 x 40 mm
Pole size : 9mm φ

STANDARD ACCESSORIES

- Carrying case
- Corner adapter
- Hexagonal wrench

Product Link



PRODUCT NAME	MODEL	PKG QTY	MOQ	CODE NO.	C/O
1.5inch Prism	MG-1500GP2	1	10	217282	CN
Mini Prism Accessory (Ref. Page 040)	MP-A	-	5	031070	JP

NEW SERVICE PRINT STICKER

We make up quality and high weatherability sticker with Japanese Top-brand printer.

As new myzox service, we offer custom stickers for any business, big or small.
You can order high quality stickers in any size, any shape and any quantity.
We hope our new service will support your business.



Target Items

- Tripod
- Staff
- Line Laser
- Rotating Laser
- Auto Level
- Promotional goods
- Company sticker

Sticker Size

- Small : up to 10cm²
- Medium : up to 50cm²
- Large : up to 50~200cm²

Color

Printed Paper: White
Printing Color: Free

DRONE

- YOROI
- KATANA



CUSTOMIZABLE DRONE FROM MYZOX

MYZOX & SAITOTEC starts drone related business for rapidly raised drone industries.

SAITOTEC is a Japanese drone manufacturer having huge potential for made-to-order drones.

We are ready to provide solutions with our customizable drone for your professional work.

TRIPOD
1

PRISM
2

POLE
3

STAFF
4

GNSS ACCESSORY
5

SURVEYING / LASER INSTRUMENT
6

SURVEYING ACCESSORY
7

MEASURING TOOL
8

TESTING INSTRUMENT
9

SECURITY GOODS
10

YOROI

Robust type Base model Operability Stability Waterproof

Crop-dusting, Material handling, 3D surveying, Photo surveying



Remote controller



“YOROI” means Japanese samurai armor which structured by many iron detail parts, unbelievably tough yet able to move fast like hornet. YOROI series have robust structure by carbon shell to carry heavy weight material with stable flight.

Features

Heavy weight loading

Powerful motors and lightweight body achieve heavy weight loading with smooth flight.

IP resistance for heavy-duty usage

Seamless designed carbon body protect against from rain and dust.

Stylish design carbon shell body

Black carbon shell body is associated with black hornet. It is very stylish unlike any other drones.



SPECIFICATIONS

Model	YR6S1500MG	
Size	Width	1,592mm
	Depth	1,393mm
	Height	693 ~ 793mm
Propellers	6	
Diagonal motor distance	1,500mm	
Weight	11.4kg	
Max. operating time	18min.	
Max. payload	9kg	
Propeller diameter	28inch	
Power battery	18,000mAh 12S LiPo*	
Max. service ceiling	2,500m	
Max. flying speed	60km/h	
Max. operating wind speed	10m/s	
Water & dust protection	IP34	
Accessories	Carrying case Standard work skid	

*Battery is an intelligent type.

KATANA

All-rounder type **Base model** **Versatility** **Expandability** **Endurance**

Inspection, Disaster research, 3D surveying, Photo surveying, Solar inspection

"KATANA" means Japanese samurai sword. Traditional manufacturing process creates a blade super sharp and lightweight. KATANA series are wide variety patterns of customization with thin carbon double plates.



Features

High customizability

Simple double carbon plates structure brings high customizability.

24h flying drone

Optional power supply gives drone for limitless flying time like 24 hours.

Wall climbing with wheels

Optional wheels bring drone to climb wall like spider.

SPECIFICATIONS

Model	KT6S1500MG	KT4S1050MG	KT4S540MG
Size	Width	1,592mm	850mm
	Depth	1,393mm	850mm
	Height	685mm	685mm
Propellers	6	4	4
Diagonal motor distance	1,500mm	1,050mm	540mm
Weight	12.4kg	8.5kg	1.5kg
Max. operating time	18min.	15min.	10min.
Max. payload	8kg	5kg	0.8kg
Propeller diameter	28inch	28inch	11inch
Power battery	18,000mAh	18,000mAh	6,000mAh
	12S LiPo*	12S LiPo*	4S LiPo*
Max. service ceiling	2,500m	2,500m	2,500m
Max. flying speed	45km/h	45km/h	60km/h
Max. operating wind speed	6m/s	6m/s	6m/s
Water & dust protection	-	-	-
Accessories	Carrying case	Carrying case	Carrying case
	Standard work skid	Standard work skid	

*Battery is an intelligent type.

KATANA

Practice model

SPECIFICATIONS

Model	KT4S450MG	
Size	Width	630mm
	Depth	630mm
	Height	325mm
Propellers	4	
Diagonal motor distance	450mm	
Weight	1.3kg	
Max. operating time	7min.	
Max. payload	1.3kg	
Propeller diameter	11inch	
Power battery	5,500mAh	
	3S LiPo	
Max. service ceiling	2,500m	
Max. flying speed	60km/h	
Max. operating wind speed	6m/s	
Water & dust protection	-	
Accessories	Carrying case	



✓ CHECK

What is KATANA practice model?

Generally recreational drone has built in control system by microprocessor and software in order to pilot drone easily. However the industrial drone is generally designed and created based on manual pilot so that pilot can do precise work on drones.

MYZOX line up KATANA practice model which has very close feeling of actual unit in order to pilot industrial drone without any anxiety.



1 TRIPOD
2 PRISM
3 POLE
4 STAFF
5 GNSS ACCESSORY
6 SURVEIVING / LASER INSTRUMENT
7 SURVEIVING ACCESSORY
8 MEASURING TOOL
9 TESTING INSTRUMENT
10 SECURITY GOODS



MYZOX & SAITOTEC CREATES NEW SOLUTIONS

MYZOX starts to have original drones in our lineups from August, 2018. Productivity, IT, Labor-saving is common words in many job sites. Drones are one of innovative solutions and the usage of drones are expanding in various job sites.

MYZOX unique drones solve issues and difficulties of surveying, construction and agriculture sites or others with professional customization by teamed up with SAITOTEC.



Agriculture



Inspection



Material handling

60 years experience

MYZOX have a great deal of experience and knowledge for the surveying, civil engineering and construction industries. With these experience and knowledge, MYZOX provides the best solutions for many application difficulties with drones.



Technical capacity

SAITOTEC is a pioneer in customizing drone market. They create the trust of major enterprises SOFTBANK or SUMITOMO HEAVY INDUSTRIES through more than 10 years. The possibility of our drone customizing is unlimited and providing solution for any difficulties.



Our drone features

24h Flying drone



By special designed lightweight cable and power transmitter, the drone flies more than 24 hours in theory.

Heavy-duty



By mounting powerful multi-motors, the drone can load heavy material like packages or agricultural chemical.

Customization



By a lot of experience with industrial professionals, it is possible to customize for any job applications.

1 TRIPOD
2 PRISM
3 POLE
4 STAFF
5 GNSS ACCESSORY
6 SURVEYING / LASER INSTRUMENT
7 SURVEYING ACCESSORY
8 MEASURING TOOL
9 TESTING INSTRUMENT
10 SECURITY GOODS



01 TRIPOD



- Aluminium Tripod P020
- Wooden Tripod P024
- GNSS Tripod / Bipod P025
- Elevating Tripod P026
- Prism Pole Tripod P027
- Laser Tripod / Tripod Accessory P028



TRIPOD

1

PRISM

2

POLE

3

STAFF

4

GNSS ACCESSORY

5

SURVEYING / LASER INSTRUMENT

6

SURVEYING ACCESSORY

7

MEASURING TOOL

8

TESTING INSTRUMENT

9

SECURITY GOODS

10

Myzox's Tripods

What is the Best Tripod?

Almost people think measuring accuracy is brought by an instrument accuracy and a surveyor's skill. It's generally true, but there is one more important factor, which is accessories such as tripods, prisms or leveling staves.

Myzox's tripods are developed with every situation in mind. Wooden Tripod is heavy but absorbs the vibration from ground, and thermal expansion rate is low. When you need a precision surveying, the wooden tripod works well. Thermal expansion rate of aluminium Tripod is higher than wooden one. But it's light weight to carry around. It's suitable for surveying with auto level.



Wooden Tripod



Aluminium Tripod

Time to Get New Tripod

Damages of tripod may effect the accuracy of measuring. Please check the timing to get new tripod.

Urgency of replacement

High

High Urgency

Dent or Scratch on Tripod Head
The bubble moving after tightening screw may be caused by dents or scratches.

Middle Urgency

Damage of Tripod Leg
The damage of tripod leg may not cause measuring error soon. But the instrument may fall down by the damage getting worse.

Low Urgency

Low

Abration of Fixing Screw or Shoe Tip
It's replaceable parts.

International Standard



The surveying tripod requirements are defined by the International Standard (ISO 12858-2) in terms of height stability under load and torsional rigidity. In addition to these requirements, Myzox also evaluates the paint adhesion salt resistance and the horizontal drift. These properties were tested on a range of tripods. Myzox tripods pass these series of stringent tests and ensure precision and stable measurements.

Aluminium Tripod LAN series

P.020



LAN2-OL

LAN2-YD

LAN2-GL

Aluminium Tripod Quick Lock type

P.021



LANQ-OL

Aluminium Tripod Dual Lock type

P.020



DAT-OL

Wooden Tripod

P.024



PMW3-OL

Wide Range of Tripods

Standard



LAN2-OL
P.020

Full extended	1,700mm
Weight	3.9kg

for Narrow



LANS-OL
P.022

Full extended	745mm
Weight	3.1kg

with Rotating Laser High Torsional Rigidity



SDXS-OD
P.023

Full extended	1,100mm
Weight	3.5kg



SDX-OD
P.021

Full extended	1,675mm
Weight	4.1kg

for GNSS



SKY-OL
P.025

Full extended	3,570mm
Weight	6.3kg

High Weather ability



PMW3-OL
P.024

Full extended	1,753mm
Weight	6.7kg

Reliable Locks



PMWD3-OL
P.024

Full extended	1,691mm
Weight	8.2kg

for Forestry Surveying



PMWS-YL
P.024

Full extended	1,655mm
Weight	4.1kg

Shifting Locking Handle



NEL-33SL
P.026

Full extended	1,735mm
Weight	6.2kg

for Laser



LET-B
P.028

Full extended	1,710mm
Weight	1.35kg

High Place Work



KEL-300
P.026

Full extended	3,010mm
Weight	6.8kg

for Prism Pole



PPS
P.027

Full extended	1,230mm
Weight	1.45kg

There are still many other tripods. Please check following product pages!!

Aluminium Tripod Round Leg

LAN series

ISO STANDARD

LAN series meets ISO STANDARD. Durable body with Myzox original structure is suitable for various instruments.



Dual Lock
DAT-OL

Quick Lock
LANQ-YL

Screw Lock
LAN(2)-GL

✓ CHECK

HIGH DURABILITY

Round leg is quite resistant to pressure from any angles.

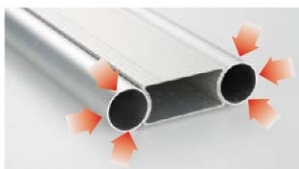

Sectional View

✓ CHECK

ISO STANDARD

ISO standard checks specifications such as weight, length of tripods or torsional rigidity and so on. LAN series meets ISO STANDARD. It means that LAN series is global standard type of tripod.



✓ CHECK

DUAL LOCK SYSTEM

When setting the light instrument, it is enough to lock with quick clamp. When setting the heavy instrument, it is good to lock with screw clamp. Setting the tripod is easy and efficient by using quick and screw clamp, and you get more safety.



▶ TRIPOD HEAD



FLAT

DOMES

▶ COLOR



ORANGE

YELLOW

GRAY

▶ SPECIFICATIONS

Model	LAN(2)-OL	LAN(2)-OD	LAN(2)-YL	LAN(2)-YD	LAN(2)-GL	LAN(2)-GD
Full extended	1,699mm	1,713mm	1,699mm	1,713mm	1,699mm	1,713mm
Full closed	1,030mm	1,044mm	1,030mm	1,044mm	1,030mm	1,044mm
Weight	3.9kg	3.9kg	3.9kg	3.9kg	3.9kg	3.9kg
Tripod head size	160 / 66mm	160 / 44mm	160 / 66mm	160 / 44mm	160 / 66mm	160 / 44mm

Model	LANQ-OL	LANQ-OD	LANQ-YL	LANQ-YD	DAT-OL	DAT-YL
Full extended	1,700mm	1,714mm	1,700mm	1,714mm	1,700mm	1,700mm
Full closed	1,060mm	1,074mm	1,060mm	1,074mm	1,060mm	1,060mm
Weight	4.2kg	4.2kg	4.2kg	4.2kg	4.3kg	4.3kg
Tripod head size	160 / 66mm	160 / 44mm	160 / 66mm	160 / 44mm	160 / 66mm	160 / 66mm

▶ STANDARD ACCESSORIES

- Wrench



Product Link

Product movie

PRODUCT NAME	MODEL	PKG QTY	MOQ	CODE NO.	C/O
Tripod / Screw Lock / Orange / Flat	LAN(2)-OL	1	10	041152	CN(VN)
Tripod / Screw Lock / Orange / Dome	LAN(2)-OD	1	10	041154	CN(VN)
Tripod / Screw Lock / Yellow / Flat	LAN(2)-YL	1	10	041166	CN(VN)
Tripod / Screw Lock / Yellow / Dome	LAN(2)-YD	1	10	041168	CN(VN)
Tripod / Screw Lock / Gray / Flat	LAN(2)-GL	1	10	218453	CN(VN)
Tripod / Screw Lock / Gray / Dome	LAN(2)-GD	1	10	218455	CN(VN)

PRODUCT NAME	MODEL	PKG QTY	MOQ	CODE NO.	C/O
Tripod / Quick Lock / Orange / Flat	LANQ-OL	1	10	041156	CN
Tripod / Quick Lock / Orange / Dome	LANQ-OD	1	10	041158	CN
Tripod / Quick Lock / Yellow / Flat	LANQ-YL	1	10	041159	CN
Tripod / Quick Lock / Yellow / Dome	LANQ-YD	1	10	-	CN
Tripod / Dual Lock / Orange / Flat	DAT-OL	1	10	219344	CN
Tripod / Dual Lock / Yellow / Flat	DAT-YL	1	10	219372	CN

Aluminium Tripod Square Leg

SDX series

HIGH TORSIONAL RIGIDITY

SDX series is strong against torsion due to its square leg. Durable body with Myzox original structure is suitable for various instruments.



✓ CHECK

TORSIONAL RIGIDITY

Square pipe has more torsional rigidity than other leg shapes. With high torsional rigidity, the error caused by rotation of the instrument can be minimized.

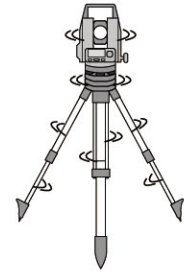

▶ TRIPOD HEAD



FLAT

DOME

▶ COLOR



ORANGE

YELLOW

▶ SPECIFICATIONS

Model	SDX-OL	SDX-OD	SDX-YL	SDX-YD
Full extended	1,672mm	1,686mm	1,672mm	1,686mm
Full closed	1,001mm	1,015mm	1,001mm	1,015mm
Weight	4.1kg	4.1kg	4.1kg	4.1kg
Tripod head size	160 / 66mm	160 / 44mm	160 / 66mm	160 / 44mm

PRODUCT NAME	MODEL	PK/G QTY	MOQ	CODE NO.	C/O
Tripod / Screw Lock / Orange / Flat	SDX-OL	1	10	210110	CN
Tripod / Screw Lock / Orange / Dome	SDX-OD	1	10	210112	CN
Tripod / Screw Lock / Yellow / Flat	SDX-YL	1	10	210381	CN
Tripod / Screw Lock / Yellow / Dome	SDX-YD	1	10	210383	CN



Product Link

Aluminium Tripod Square Leg (Heavy-duty)

GAT series

HEAVY-DUTY

GAT series is heaviest aluminium tripod. Suitable for heavy instruments such as Total Stations and 3D scanners.



✓ CHECK

HEAVIEST ALUMINIUM TRIPOD

GAT series is the heaviest aluminium tripod. It is suitable for surveyors who use heavy instruments.

The body is heavy, so GAT keeps stable even mounting of heavy instrument.

RANKING OF WEIGHT

1st GAT series
(4.5kg)

2nd SDX series
(4.1kg)

3rd LAN series
(3.9kg)

✓ CHECK

TORSIONAL RIGIDITY

Square pipe has more torsional rigidity than other leg shapes. With high torsional rigidity, the error caused by rotation of the instrument can be minimized.

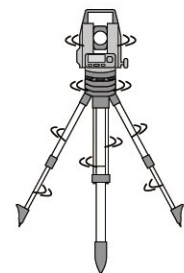
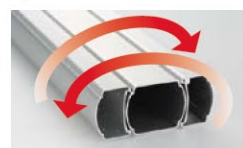

▶ TRIPOD HEAD



FLAT

▶ COLOR



ORANGE

YELLOW

▶ SPECIFICATIONS

Model	GAT-OL	GAT-YL
Full extended	1,755mm	1,755mm
Full closed	1,055mm	1,055mm
Weight	4.5kg	4.5kg
Tripod head size	160 / 65mm	160 / 65mm

PRODUCT NAME	MODEL	PK/G QTY	MOQ	CODE NO.	C/O
Tripod / Screw Lock / Orange / Flat	GAT-OL	1	10	219341	CN
Tripod / Screw Lock / Yellow / Flat	GAT-YL	1	10	219390	CN



Product Link

Aluminium Tripod Round Leg

SAT series

SPECIALIZED FOR AUTOMATIC LEVEL

SAT series is suitable for automatic level & rotating laser, and has light body.

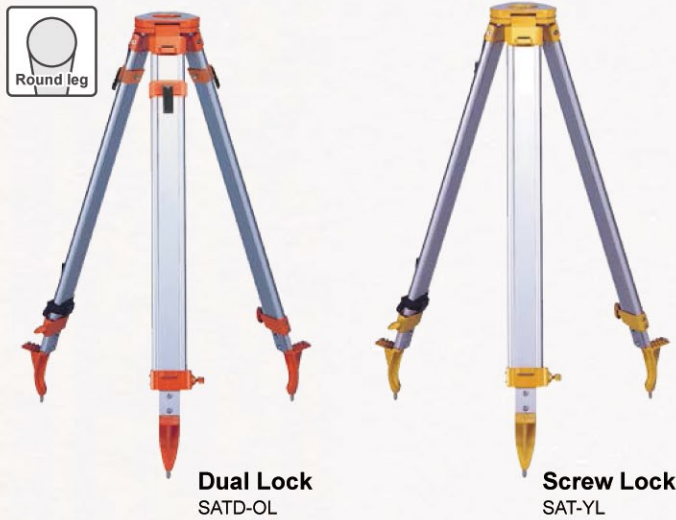

Dual Lock
SATD-OL

Screw Lock
SAT-YL

► TRIPOD HEAD



FLAT

DOME

► COLOR



ORANGE

YELLOW

✓ CHECK

DUAL LOCK SYSTEM

When setting the light instrument, it is enough to lock with quick clamp. When setting the heavy instrument, it is good to lock with screw clamp. Setting the tripod is easy and efficient by using quick and screw clamp, and you get more safety.



✓ CHECK

HIGH DURABILITY

Round leg is quite resistant to pressure from any angles.



Sectional View

► SPECIFICATIONS

Model	SAT-OL	SAT-OD	SAT-YL	SAT-YD
Full extended	1,655mm	1,665mm	1,655mm	1,665mm
Full closed	978mm	988mm	978mm	988mm
Weight	3.5kg	3.5kg	3.5kg	3.5kg
Tripod head size	154 / 66mm	144 / 42mm	154 / 66mm	144 / 42mm

Model	SATQ-OL	SATQ-OD	SATQ-YL	SATQ-YD
Full extended	1,700mm	1,714mm	1,700mm	1,714mm
Full closed	1,060mm	1,074mm	1,060mm	1,074mm
Weight	3.8kg	3.8kg	3.8kg	3.8kg
Tripod head size	154 / 66mm	144 / 42mm	154 / 66mm	144 / 42mm

Model	SATD-OL	SATD-OD	SATD-YL	SATD-YD
Full extended	1,660mm	1,670mm	1,660mm	1,670mm
Full closed	1,240mm	1,250mm	1,240mm	1,250mm
Weight	3.9kg	3.9kg	3.9kg	3.9kg
Tripod head size	154 / 66mm	144 / 42mm	154 / 66mm	144 / 42mm



Product Link

Short Aluminium Tripod Round Leg

LANS-OL

FOR NARROW SPACE

It's small but robust.

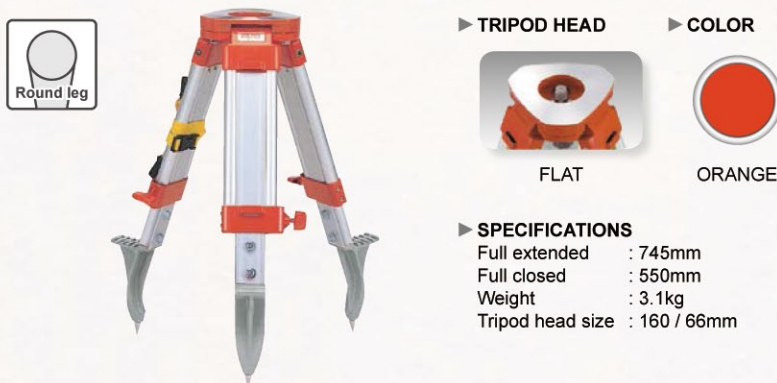

► TRIPOD HEAD



FLAT

► COLOR



ORANGE

► SPECIFICATIONS

Full extended : 745mm
Full closed : 550mm
Weight : 3.1kg
Tripod head size : 160 / 66mm

PRODUCT NAME	MODEL	PKG QTY	MOQ	CODE NO.	C/O
Tripod / Screw Lock / Short / Orange / Flat	LANS-OL	1	10	041161	CN

✓ CHECK

SPECIALIZED FOR NARROW SPACE

LANS-OL is a short type of LAN Tripods. Body is small and light, but still robust. It is specialized for narrow space, such as tunnel or water & sewerage work.



Aluminium Tripod Round Leg

ET series

FOR YOUR MOBILITY

ET series is a good mobility tripod, and suitable for automatic level and rotating laser.



Screw Lock
ET-GL

Quick Lock
ETQ-YL

► **TRIPOD HEAD**



FLAT



DOME

► **COLOR**



ORANGE



YELLOW



GREEN

► **SPECIFICATIONS**

Model	ET-OL	ET-OD	ET-YL	ET-YD	ET-GL	ET-GD
Full extended	1,652mm	1,662mm	1,652mm	1,662mm	1,652mm	1,662mm
Full closed	980mm	990mm	980mm	990mm	980mm	990mm
Weight	3.2kg	3.2kg	3.2kg	3.2kg	3.2kg	3.2kg
Tripod head size	125 / 37mm	124 / 40mm	125 / 37mm	124 / 40mm	125 / 37mm	124 / 40mm

Model	ETQ-OL	ETQ-OD	ETQ-YL	ETQ-YD	ETQ-GL	ETQ-GD
Full extended	1,647mm	1,661mm	1,647mm	1,661mm	1,647mm	1,661mm
Full closed	1,009mm	1,023mm	1,009mm	1,023mm	1,009mm	1,023mm
Weight	3.5kg	3.5kg	3.5kg	3.5kg	3.5kg	3.5kg
Tripod head size	125 / 37mm	124 / 40mm	125 / 37mm	124 / 40mm	125 / 37mm	124 / 40mm



Product Link

PRODUCT NAME	MODEL	PKG QTY	MOQ	CODE NO.	C/O
Tripod / Screw Lock / Orange / Flat	ET-OL	1	10	221415	CN
Tripod / Screw Lock / Orange / Dome	ET-OD	1	10	-	CN
Tripod / Screw Lock / Yellow / Flat	ET-YL	1	10	-	CN
Tripod / Screw Lock / Yellow / Dome	ET-YD	1	10	-	CN
Tripod / Screw Lock / Green / Flat	ET-GL	1	10	219312	CN
Tripod / Screw Lock / Green / Dome	ET-GD	1	10	219392	CN

PRODUCT NAME	MODEL	PKG QTY	MOQ	CODE NO.	C/O
Tripod / Quick Lock / Orange / Flat	ETQ-OL	1	10	-	CN
Tripod / Quick Lock / Orange / Dome	ETQ-OD	1	10	-	CN
Tripod / Quick Lock / Yellow / Flat	ETQ-YL	1	10	240022	CN
Tripod / Quick Lock / Yellow / Dome	ETQ-YD	1	10	240023	CN
Tripod / Quick Lock / Green / Flat	ETQ-GL	1	10	500515	CN
Tripod / Quick Lock / Green / Dome	ETQ-GD	1	10	-	CN

Short Aluminium Tripod Square Leg

SDXS-OD

FOUNDATION WORK

Sometimes smaller is better.



► **TRIPOD HEAD**



DOME

► **COLOR**



ORANGE

► **SPECIFICATIONS**

Full extended	: 1,086mm
Full closed	: 715mm
Weight	: 3.5kg
Tripod head size	: 160 / 44mm

✓ CHECK

SPECIALIZED FOR FOUNDATION WORK

SDXS-OD is specialized in using under 1m height such as foundation work. The body is robust, and easy handling by small body.

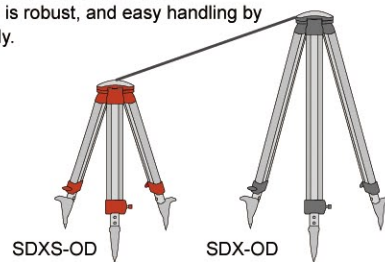

SDXS-OD

SDX-OD



Product Link

PRODUCT NAME	MODEL	PKG QTY	MOQ	CODE NO.	C/O
Tripod / Screw Lock / Short / Orange / Dome	SDXS-OD	1	10	217199	CN

TRIPOD 1
PRISM 2
POLE 3
STAFF 4
GNSS ACCESSORY 5
SURVEYING / LASER INSTRUMENT 6
SURVEYING ACCESSORY 7
MEASURING TOOL 8
TESTING INSTRUMENT 9
SECURITY GOODS 10

NEW Precision Wooden Tripod PMW series

VARIOUS TYPES

Myzox has several types of Wooden Tripod.



Japan made
PMW3-OL



Dual Lock
PMWD3-OL



Light weight
PMWS-YL

► FEATURES

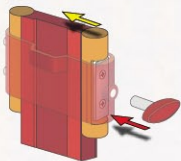

Direct fixation



Torque adjustable from side
(PMW3 / PMW4 / PMWD3)



Drainage structure
(PMW3 / PMW4 / PMWD3)



Tripod head cover
(PMW3 / PMW4 / PMWD3)



Wrench is storable



FLAT

► TRIPOD HEAD

✓ CHECK

VARIOUS WOODEN TRIPODS

Myzox has various types of Wooden Tripod. Choosing the proper tripod based on working conditions brings saving your power, time and money. A top surveyor care about invisible value. The most important thing in wooden tripod is not visible value like price. PMW series supply the following invisible value.

- High stability as base of instruments
- High torsional stiffness
- Low dilatibility

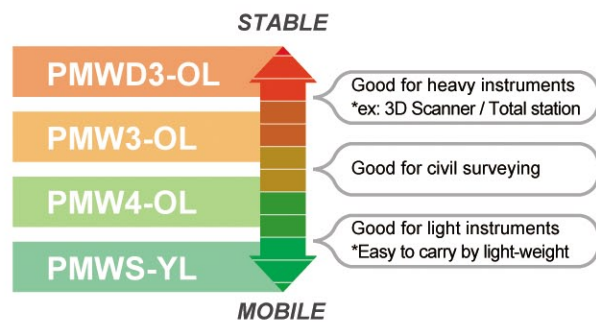

► SPECIFICATIONS

Model	PMW3-OL	PMW4-OL	PMW4-YL	PMWD3-OL	PMWS-YL
Full extended	1,754mm	1,754mm	1,754mm	1,691mm	1,655mm
Full closed	1,092mm	1,092mm	1,092mm	1,090mm	1,010mm
Weight	6.7kg	7.2kg	7.2kg	8.3kg	4.0kg
Tripod head size	160 / 56mm	160 / 56mm	160 / 56mm	160 / 56mm	150 / 55mm

PRODUCT NAME	MODEL	PKG QTY	MOQ	CODE NO.	C/O
Tripod / Screw Lock / Red / Flat	PMW3-OL	1	10	222053	JP
Tripod / Screw Lock / Red / Flat	PMW4-OL	1	10	222059	CN
Tripod / Screw Lock / Yellow / Flat	PMW4-YL	1	10	222060	CN
Tripod / Dual Lock / Red / Flat	PMWD3-OL	1	10	222058	CN
Tripod / Dual Lock / Yellow / Flat	PMWD3-YL	1	10	222061	CN
Tripod / Screw Lock-Light / Yellow / Flat	PMWS-YL	1	10	218703	JP

PMW series



Product Link

PMWD series



Product Link

NEW **Fiberglass Wooden Tripod**
PGF4-OL

HYBRID TRIPOD

PGF4-OL has both strong points of fiberglass (unaffected from climate) and woods (high vibration absorption).

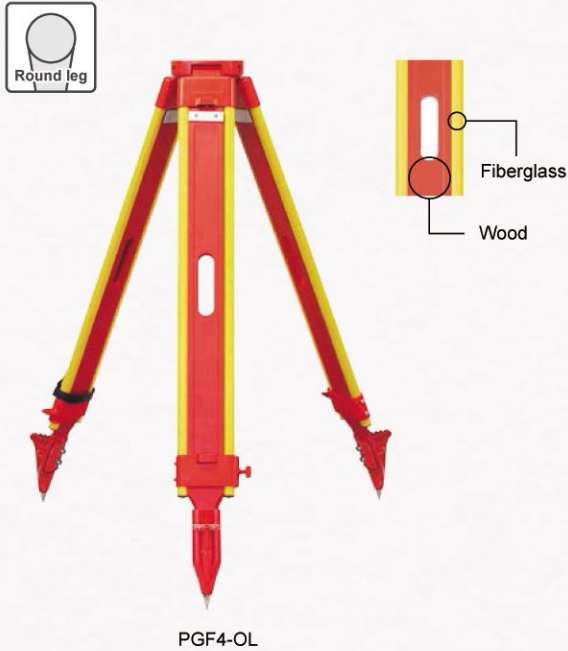

PGF4-OL

► **FEATURES**



Torque adjustable from side



Tripod head cover

✓ **CHECK**

HYBRID MATERIAL

PGF4-OL's leg part consist of Fiberglass part and Wooden part. So it has strong points of both materials.

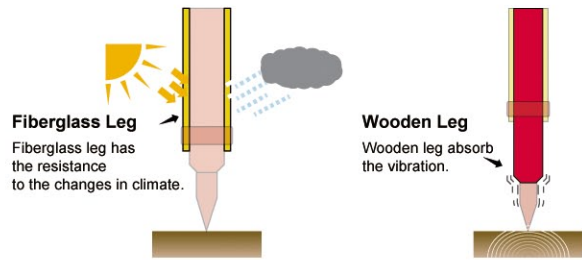

► **SPECIFICATIONS**

- Full extended : 1,754mm
- Full closed : 1,090mm
- Weight : 7.6kg
- Tripod head size : 160 / 56mm



Product Link

PRODUCT NAME	MODEL	PKG QTY	MOQ	CODE NO.	C/O
Tripod / Screw Lock / Red / Flat	PGF4-OL	1	10	222275	CN

GNSS Aluminium Tripod

SKY-OL

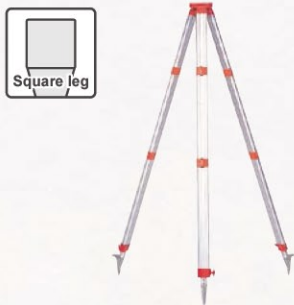

FOR GNSS ANTENNA
SKY-OL is good for GNSS use.

► **TRIPOD HEAD**



FLAT

► **COLOR**



ORANGE

✓ **CHECK**

GNSS TRIPOD

SKY-OL is specialized design for GNSS Surveying (3.5m). It's good for GNSS antenna, Mapping works.



► **SPECIFICATIONS**

- Full extended : 3,570mm
- Full closed : 1,940mm
- Weight : 6.3kg
- Tripod head size : 160 / 66mm



Product Link

PRODUCT NAME	MODEL	PKG QTY	MOQ	CODE NO.	C/O
Tripod / Screw Lock / Orange / Flat	SKY-OL	1	10	041140	CN

Bipod

BIP-180



THUMB RELEASE

It is easy to get the level by thumb release.



Rustproof stainless shoe

* The pole is an optional product.

✓ **CHECK**

QUICK THUMB RELEASE

It is easy to set up as leveling with one push on quick thumb release.



► **SPECIFICATIONS**

- Full extended : 1,800mm
- Full closed : 1,064mm
- Weight : 2.15kg
- Pole size : 21 ~ 38mmφ

► **STANDARD ACCESSORIES**

- Carrying case



Product Link

PRODUCT NAME	MODEL	PKG QTY	MOQ	CODE NO.	C/O
Bipod	BIP-180	4	4	217426	CN

Elevating Tripod

NEL series

SMOOTH ELEVATING

NEL series has smooth elevating systems with 2 types (Dustproof Type, Graduated Type).

► FEATURES



Tripod head cover



Safety chain



Wide space



Adjustable level



Black alumite



Graduation (NEL-60SL)



NEL-33SL

NEL-60SL

✓ CHECK

SMOOTH ELEVATING

NEL series has smooth elevating system. Smooth elevating enables to set lasers up with ideal height easily.

DUST-PROOF & GRADUATED

Dust-proof type keeps smooth elevating by preventing the inflow of sand. Graduated type brings easy setting with graduation on the pole.



Smooth elevating



Graduated type



Dust-proof type

► SPECIFICATIONS

Model	NEL-18SL	NEL-33SL	NEL-33L	NEL-60SL	NEL-60L
Full extended	1,180mm	1,735mm	2,334mm	1,896mm	2,497mm
Full closed	830mm	1,030mm	1,328mm	916mm	1,216mm
Elevating range	180mm	335mm	335mm	610mm	610mm
Tripod head	148mm φ	148mm φ	148mm φ	148mm φ	148mm φ
Weight	5.6kg	6.2kg	7.1kg	5.6kg	6.2kg

PRODUCT NAME	MODEL	PKG QTY	MOQ	CODE NO.	C/O
Tripod / Dustproof / Orange / Flat	NEL-18SL	1	10	217486	CN
Tripod / Dustproof / Orange / Flat	NEL-33SL	1	10	217487	CN
Tripod / Dustproof / Orange / Flat	NEL-33L	1	10	219396	CN
Tripod / Graduated / Orange / Flat	NEL-60SL	1	10	500295	CN
Tripod / Graduated / Orange / Flat	NEL-60L	1	10	-	CN



Product Link

Elevating Tripod (Tall-type)

KEL-300

HIGH PLACE WORKING

It is the tallest model in Myzox product lineup.



✓ CHECK

HIGH PLACE WORKING

KEL-300 is specially designed for high place working such as ceiling work. For safety, Air-damping system has installed on the elevating part in order to avoid accident.

► SPECIFICATIONS

Full extended	: 3,010mm
Full closed	: 1,260mm
Weight	: 6.8kg
Tripod head size	: 148mm φ
Elevating range sec.1	: 540mm
Elevating range sec.2	: 530mm

PRODUCT NAME	MODEL	PKG QTY	MOQ	CODE NO.	C/O
Tripod / Orange / Flat	KEL-300	1	5	217425	CN



Product Link

Prism Pole Tripod

PPS series

ADJUST EASILY

PPS series has different types of clamp, and every clamp makes easier to adjust pole for setting.

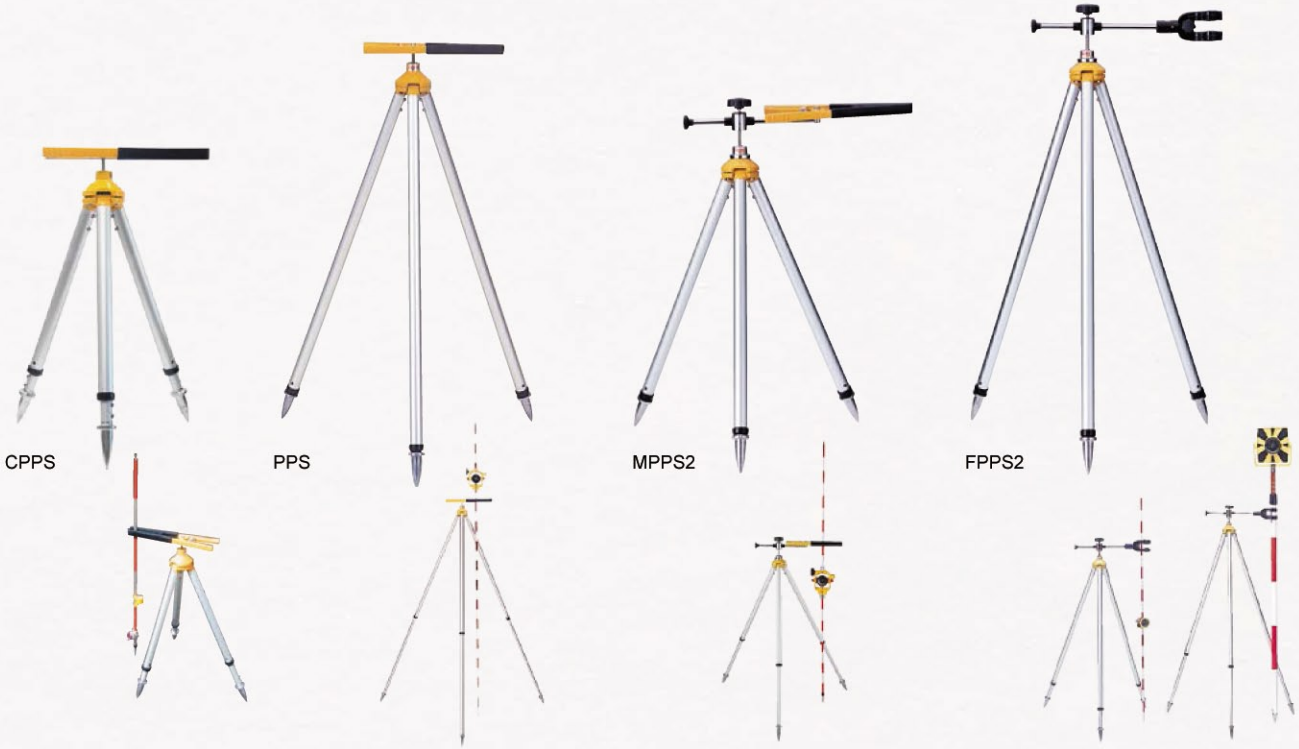

▶ 360° ROTATING GRIP (CPPS , PPS , MPPS2)

▶ SLIDABLE ARM (MPPS2)

▶ FLEXIBLE SYSTEM (FPPS2)

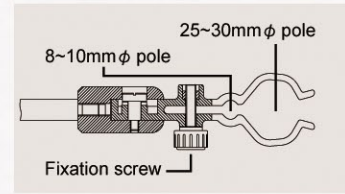

✓ CHECK

ADJUST EASILY

The most important point of prism pole tripod is easy to set up prism poles. At the point of setting up prism poles, it is necessary to adjust circular level by adjusting prism poles and prism pole tripod.

PPS series has 360° rotating clamp or flexible clamp. Both of clamp systems bring efficient works for users.



✓ CHECK

TWIST LOCK

To extend or close the legs, it is just twist. The reason we use this locking is for efficiency.

Comparing with screw lock, the withstand load may not be high. But the loading from the above is not big, this locking system is enough to support the pole.

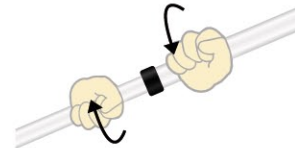

▶ SPECIFICATIONS

Model	CPPS	PPS	MPPS2	FPPS2
Full extended	630mm	1,230mm	900mm	1,280mm
Full closed	459mm	760mm	620mm	810mm
Weight	1.1kg	1.45kg	1.55kg	1.60kg
Head type	Scissors clamp	Scissors clamp	Scissors clamp	Flexible clamp
Slide range	-	-	140mm	150mm



Product Link

PRODUCT NAME	MODEL	PKG QTY	MOQ	CODE NO.	C/O
Prism Pole Tripod / Compact	CPPS	10	10	220872	CN
Prism Pole Tripod / Standard	PPS	10	10	041021	CN
Prism Pole Tripod / Slidable arm	MPPS2	10	10	217197	CN
Prism Pole Tripod / Flexible clamp	FPPS2	10	10	217198	CN

PRODUCT NAME	MODEL	PKG QTY	MOQ	CODE NO.	C/O
Case for CPPS	CPPS-C	-	10	221993	CN
Case for PPS & FPPS2	PPS-C	-	10	222238	CN
Case for MPPS2	MPPS2-C	-	10	221983	CN

Elevating Tripod for Laser

LET series



FAVORITE HEIGHT

LET series brings you your favorite height.

✓ CHECK

DOUBLE QUICK LOCK

LET series has double quick lock at each legs. Quick setting and easy adjusting by quick lock leg.



► SPECIFICATIONS

PRODUCT NAME	MODEL	PKG QTY	MOQ	CODE NO.	C/O
Tripod for Laser / Standard type	LET-B	6	6	213092	CN
Tripod for Laser / Robust type	LET-C	6	6	213696	CN
Tripod for Laser / Compact type	LET-S	8	8	215950	CN

Model	LET-B	LET-C	LET-S
Full extended	1,705mm	1,370mm	1,245mm
Full closed	605mm	525mm	410mm
Weight	1.34kg	2.42kg	0.61kg
Elevating range	305mm	240mm	245mm
Screw size	5/8inch	5/8inch	5/8inch



Product Link

Tripod Case

TPC

FOR TRIPOD LOVER

A tripod used for many years fit comfortably in your hand.

✓ CHECK

PROTECT TRIPOD

Tripod case protects tripods from damages. TPC has hard plastic at the bottom of the case.



TPC

ATC

► SPECIFICATIONS

PRODUCT NAME	MODEL	PKG QTY	MOQ	CODE NO.	C/O
Aluminium Tripod Case / Reinforced bottom	TPC	1	5	211057	JP
Aluminium Tripod Case	ATC	1	10	219337	CN
Wooden Tripod Case	WTC	1	10	219311	CN

Model	TPC	ATC	WTC
Allowance tripod length	1,060mm	1,060mm	1,210mm
External diameter	220mm	200mm	210mm
Suitable tripod	Aluminium tripod	Aluminium tripod	Wooden tripod



Product Link

Tripod Chain

TCH-2

ANTISLIP

With TCH-2, you don't worry the falling of tripod.

✓ CHECK

ADJUST LENGTH EASILY

Chain hook system makes it easy to adjust the length of chain. Also, rubber cap holds the ground tightly.

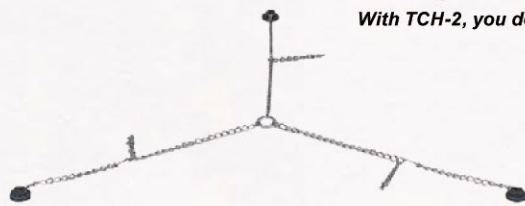

TCH-2

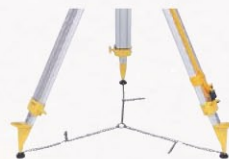

► SPECIFICATIONS

PRODUCT NAME	MODEL	PKG QTY	MOQ	CODE NO.	C/O
Tripod Chain	TCH-2	1	2	210113	JP
Tripod Chain with Magnet	TCH-M	1	2	220825	JP

Model	TCH-2	TCH-M
Full extended	620mm	620mm
Weight	260g	660g



Product Link

Slip Stopper

S-SP

GOOD FOR INDOOR USE

Make tripod head level by knowing the tripod leg opening.

✓ CHECK

METRIC GRADUATION

The extension leg has graduation. It's easy to extend 3 legs equally.



S-SP

► SPECIFICATIONS

PRODUCT NAME	MODEL	PKG QTY	MOQ	CODE NO.	C/O
Slip Stopper	S-SP	1	2	215587	JP
Slip Stopper with Magnet	S-SPM	1	2	215588	JP

Model	S-SP	S-SPM
Full extended	880mm	880mm
Full closed	440mm	440mm
Weight	750g	750g
Magnet	NO	YES



Product Link

PRISM

- 220° Prism P030
- 0.7 inch Prism P032
- 1.0 inch Prism P033
- 1.5 inch Prism P035
- DM Pin Pole P036
- 2.5 inch Prism P037
- Tribrach P039
- Prism Adapter / Prism / Prism Pole P040
- Monitoring Prism / LED Flashing Prism P041
- Prism Sheet P043



TRIPOD	1
PRISM	2
POLE	3
STAFF	4
GNSS ACCESSORY	5
SURVEYING / LASER INSTRUMENT	6
SURVEYING ACCESSORY	7
MEASURING TOOL	8
TESTING INSTRUMENT	9
SECURITY GOODS	10



Wide Angle Reflecting Target ZERO220 series

Z-220 / Z-200P

Create a new from ZERO

ZERO220 is developed based on efficiency.

- 1 TRIPOD
- 2 PRISM
- 3 POLE
- 4 STAFF
- 5 GNSS ACCESSORY
- 6 SURVEIVING / LASER INSTRUMENT
- 7 SURVEIVING ACCESSORY
- 8 MEASURING TOOL
- 9 TESTING INSTRUMENT
- 10 SECURITY GOODS



Z-220



Z-220P



View Port for Prism Center Height

For accurate measuring, the prism center height is checkable from back.



Prism Constant 0mm

The prism constant of ZERO220 is 0mm. It prevents from measuring in error.

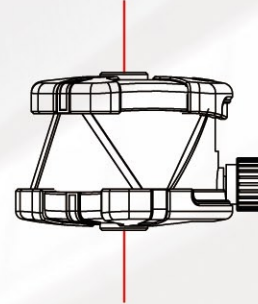

9mm diameter Pole

Widely distributed 9mm diameter pole is enabled.



Repairable Independent Prism

Each prism is independent. In case the prism is broken, it is repairable at a minimum loss.

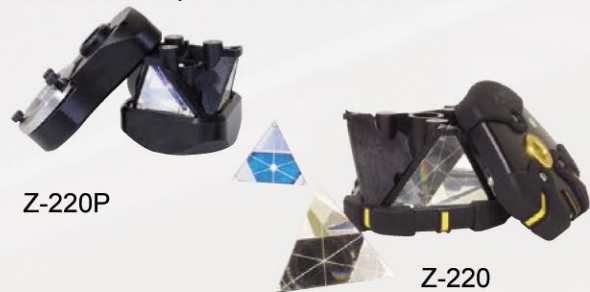

TARGETABLE RANGE

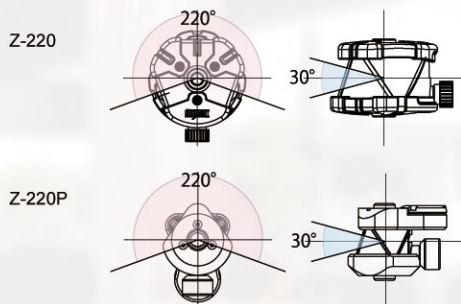

PRISM CENTER HEIGHT

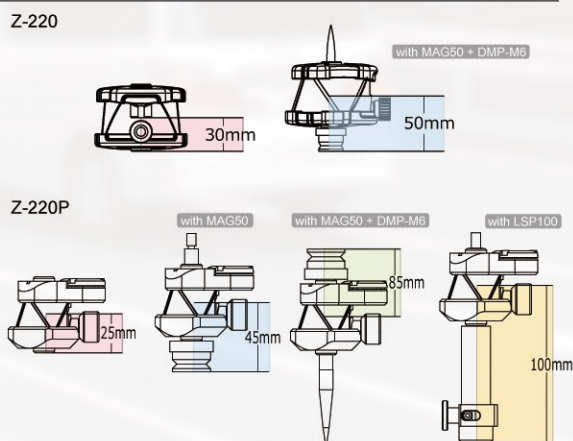

► SET CONTENTS

- | | |
|--|---|
| <ul style="list-style-type: none"> • Z-220 • Z-220P • Prism protection cover • Pole adapter MAG50 • Shoe for adapter DMP-M6 • Circular level PC-40L • Carrying case • Manual | <ul style="list-style-type: none"> • Z-220P • Z-220P • Prism protection cover • Pole adapter MAG50 • Shoe for adapter DMP-M6 • Circular level PC-40L • Carrying case • Manual • Hexagonal wrench |
|--|---|



► SPECIFICATIONS

Model	Z-220	Z-220P
Prism constant	0mm	0mm
Circular level	46' / 2mm (PC-40L)	40' / 2mm (built-in)
Size	93 x 82 x 60 mm	45 x 65 x 50 mm
Weight	196g	137g

PRODUCT NAME	MODEL	PKG QTY	MOQ	CODE NO	C/O
Wide Angle Reflecting Target	Z-220	1	10	221646	CN
Wide Angle Reflecting Target PLUS	Z-220P	1	10	222305	CN
Case for Z-220	Z-220-C	1	10	221991	CN

0.7 inch Compact Prism

M-700CP

FOR CIVIL SURVEYING

This prism prefers the words such as narrow, short distance and wall.



✓ CHECK

COMPACT BODY

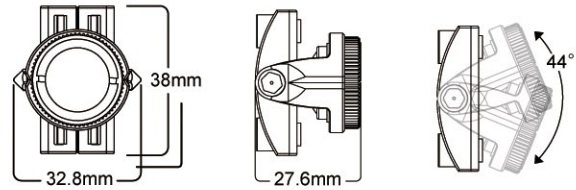

✓ CHECK

SNAP ON

M-700CP takes usability a step further. Just "SNAP ON" to attach on the pole. (9mm φ)



► SPECIFICATIONS

- Prism size : 0.7inch (18mm)
- Prism constant : 0mm
- Beam deviation : 5"
- Prism coating : Silver
- Size : 32.8 x 27.6 x 38 mm
- Pole size : 9mm φ

► STANDARD ACCESSORIES

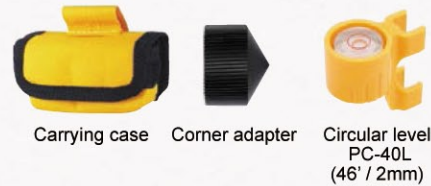

Product Link Product movie

+1 OPTION

SS Prism Pole Tripod Set



- + Compact prism M-700CP
- + SS Prism Pole Tripod PPS-SS
- + DM Pin Pole 150mm DMP-150
- + DM Pin Pole 200mm DMP-200
- + Shoe for DM Pin Pole DMP-M6
- + Case for S set

► SPECIFICATIONS(PPS-SS)

- Full extended : 306mm
- Full closed : 162mm
- Weight : approx.130g

PRODUCT NAME	MODEL	PKG QTY	MOQ	CODE NO.	C/O
0.7inch Prism	M-700CP	1	10	219431	JP
Case for M-700CP	M-700CP-C	1	10	221989	CN
SS Prism Pole Tripod Set	S set	1	10	221595	JP
SS Prism Pole Tripod	PPS-SS	1	10	221594	JP
DM Pin Pole / 150mm	DMP-150	1	10	221596	CN
DM Pin Pole / 200mm	DMP-200	1	10	221597	CN
Shoe for DM Pin Pole / Female	DMP-M6	-	5	219524	CN

0.7 inch Strap Prism

M-700HP

PORTABILITY

Strap prevents the prism from losing.



✓ CHECK

PORTABILITY & CONVENIENCE

This product focus on portability & convenience. It saves time and energy.

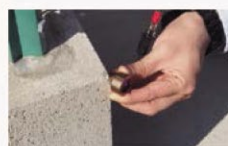

Corner measuring



Wall measuring

► SPECIFICATIONS

- Prism size : 0.7inch (18mm)
- Prism constant : 0mm
- Beam deviation : 5"
- Prism coating : Silver
- Strap length : 450mm

PRODUCT NAME	MODEL	PKG QTY	MOQ	CODE NO.	C/O
0.7inch Prism	M-700HP	1	10	220333	JP

0.7 inch Stick Prism

M-700S

HIGH PLACE WORK

M-700S put the unreachable within reach.



✓ CHECK
FLEXIBLE HEAD
 Flexible head get the point where you measure.

✓ CHECK
Point Adapter M-ADP
 M-ADP can indicate the point to measure accurately.

- **SPECIFICATIONS**
- Prism size : 0.7inch (18mm)
 - Prism constant : 0mm
 - Beam deviation : 5"
 - Prism coating : Silver

- **STANDARD ACCESSORIES**
- Carrying case
 - Point adapter

PRODUCT NAME	MODEL	PKG QTY	MOQ	CODE NO.	C/O
0.7inch Prism	M-700S	1	10	219930	JP
Point Adapter	M-ADP	1	10	220810	JP
Case for M-700S	M-700S-C	1	10	221990	CN



1.0 inch Prism 0mm / 30mm constant

PG-1000MP

ONE-MAN SURVEY

You can accurately survey alone.



✓ CHECK
WHEREVER YOU SURVEY
 Point adapter is detached from tripod. Thereby, you can measure wherever you want to survey.

- **SPECIFICATIONS**
- Prism size : 1.0inch (25mm)
 - Prism constant : 0 / -30mm
 - Beam deviation : 5"
 - Prism coating : None
 - Size : 59 x 43 x 95 mm
 - Screw : 5/8 inch female screw

- **STANDARD ACCESSORIES**
- Tribach
 - Point adapter
 - Carrying case

PRODUCT NAME	MODEL	PKG QTY	MOQ	CODE NO.	C/O
1.0inch Prism	PG-1000MP	1	10	219397	CN

TRIPOD 1
 PRISM 2
 POLE 3
 STAFF 4
 GNSS ACCESSORY 5
 SURVEYING / LASER INSTRUMENT 6
 SURVEYING ACCESSORY 7
 MEASURING TOOL 8
 TESTING INSTRUMENT 9
 SECURITY GOODS 10

1.0 inch Prism

M-1000MP

WIDE TILTING

M-1000MP has wide tilting range, upward 44 degree and downward 38 degree.



Circular level (40' / 2mm)

► **STANDARD ACCESSORIES**

- Carrying case
- Hexagonal wrench



Carrying case

PRODUCT NAME	MODEL	PKG QTY	MOQ	CODE NO.	C/O
1.0inch Prism	M-1000MP	1	10	220370	JP
Case for M-1000MP	M-1000MP-C	1	10	222280	CN

✓ **CHECK**

WIDE TILTING

M-1000MP has totally 82° wide tilting range.

Upper Tilting : 44°
Lower Tilting : 38°

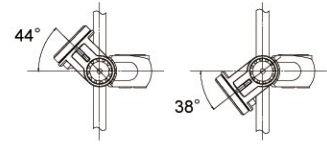

✓ **CHECK**

VIEWING SLIT

M-1000MP has viewing slit for adjusting the height of prism. It brings easier to adjust height and save working time.

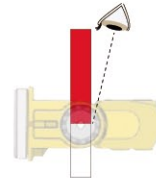

✓ **CHECK**

GOOD AXIS ACCURACY

M-1000MP holds pole at 3 points. By doing this, pole is always set at same position.

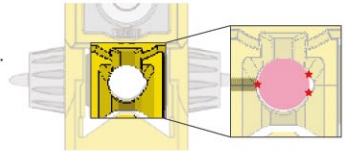

► **SPECIFICATIONS**

- Prism size : 1.0inch (25mm)
- Prism constant : 0mm
- Beam deviation : 5°
- Prism coating : Silver
- Size : 67 x 59 x 34 mm
- Pole size : 9mm φ



Product Link

Product movie

1.0 inch Prism Corner use

MG-1000SP series

SPECIALIST OF CORNER USE

Prism constant is unchangeable at any angles on corner or wall.



Push release



Circular level (40' / 2mm)



Easy-to-adjust screw for level

✓ **CHECK**

Prism Constant to Corner

17mm
(MG-1000SP)



Prism Constant to wall

12mm



► **SPECIFICATIONS**

Model	MG-1000SPT	MG-1000SP
Prism size	1.0inch (25mm)	1.0inch (25mm)
Prism constant	0mm	0mm
Beam deviation	5°	5°
Prism coating	Silver	Silver
Size	45.5 x 45 x 68 mm	35 x 45 x 68 mm
Pole size	9mm φ	9mm φ

► **STANDARD ACCESSORIES**

- Carrying case
- Hexagonal wrench
- Corner adapter
- Detachable target probe (MG-1000SP only)



Carrying case



Corner adapter

Detachable Target Probe
MG-1000SP

Fixed Target Probe
MG-1000SPT

PRODUCT NAME	MODEL	PKG QTY	MOQ	CODE NO.	C/O
1.0 inch Prism / Fixed Target	MG-1000SPT	1	10	221408	CN
1.0 inch Prism / Detachable Target	MG-1000SP	1	10	217891	CN
Case for MG-1000SP series	M-1500-C	1	10	221988	CN

1.5 inch Prism

M-1500 series

NEW STANDARD PRISM

M-1500 series is upgrade product of MG-1500 series.

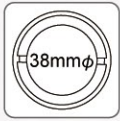

Circular level
(40' / 2mm)



M-1500GP
Dual Lock



M-1500MP

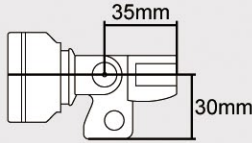

M-1500GP
Dual lock
(Screw / Quick)



M-1500MP
Screw lock

PRODUCT NAME	MODEL	PKG QTY	MOQ	CODE NO.	C/O
1.5 inch Prism Dual Lock	M-1500GP	1	10	221486	CN
1.5inch Prism	M-1500MP	1	10	221485	CN
Mini Prism Accessory (Ref. Page 044)	MP-A	-	5	031070	JP
Case for M-1500 series	M-1500-C	1	10	221988	CN
Prism Protector for Prism	SJ-M	1	10	219296	TW
Prism Protector for Body	SJ-F	1	10	221808	TW

✓ CHECK

WIDE TILTING

M-1500 series can have 5° wider elevation angle by readjusting the shape. This change brings your surveying on shorter distance.



✓ CHECK

PRINTING NAME

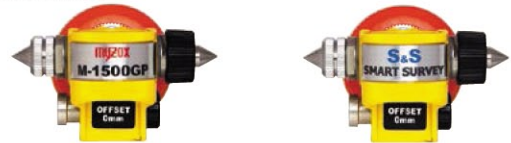

M-1500 series can change the name part easily. Our new industrial printer prints your favorite word.

▶ SPECIFICATIONS

- Prism size : 1.5inch (38mm)
- Prism constant : 0mm
- Beam deviation : 2" - 3"
- Prism coating : Silver
- Size : 80.6 x 73 x 53.3 mm
- Pole size : 9mm φ

▶ STANDARD ACCESSORIES

- Carrying case
- Hexagonal wrench
- Corner adapter (Built-in)

+1 OPTION

Prism Protector SJ series



▶ SUITABLE PRODUCT

- SJ-M (for Prism) : M-1500MP/GP, MG-1500SL, MG-1504Y/B
- SJ-F (for Body) : M-1500MP/GP

1.5 inch Prism 0mm / 30mm constant

MG-1500SL

PRISM CONSTANT CHANGEABLE

MG-1500SL is Prism Constant Changeable, 0mm / -30mm.



with SL-A



Circular level
(30' / 2mm)

✓ CHECK

PRISM CONSTANT CHANGEABLE

MG-1500SL can be used with suitable Prism Constant. Changeable Prism Constant. (0mm / -30mm)



0mm

-30mm

▶ SPECIFICATIONS

- Prism size : 1.5inch (38mm)
- Prism constant : 0mm / -30mm
- Beam deviation : 2" - 3"
- Prism coating : Silver
- Size : 115 x 70 x 20 mm
- Pole size : 9mm φ



Product Link

▶ STANDARD ACCESSORIES

- Carrying case
- Corner adapter
- Hexagonal wrench



Carrying Case



Corner adapter

PRODUCT NAME	MODEL	PKG QTY	MOQ	CODE NO.	C/O
1.5inch Prism	MG-1500SL	1	10	031060	CN
Mini Prism Accessory Set (Ref. Page 044)	SL-A	-	5	031071	JP
Case for MG-1500SL	MG-1500SL-C	1	10	221992	CN

DM Pin Pole Colorfast type

MPP series

COLORFAST

MPP series has colorfast structure by resin, never peel off the color by sliding prisms.



MPP-18

MPP-12

▶ POLE DIAMETER

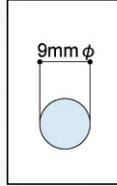

▶ ROBUST JOINT

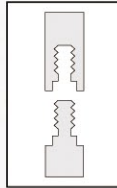

CHECK

COLORFAST STRUCTURE

Red parts are made of resin to maintain the color. When sliding prisms on DM pin poles, conventional pole will lose color. But MPP series use 1mm thick resin to avoid losing color.

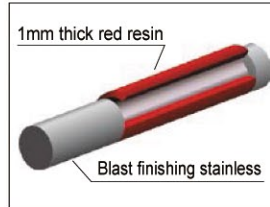

▶ SPECIFICATIONS

Model	MPP-18	MPP-12	MPP-10
Full extended	1,800mm	1,250mm	1,000mm
Section	600mm / 3 sec.	300mm / 3 sec. 350mm / 1 sec.	1,000mm / 1 sec.
Material	Stainless & resin	Stainless & resin	Stainless & resin
Color interval	100mm interval	50mm interval	100mm interval
Case	MPP-C (Plastic)	MPP-SC (Fabric)	MPP-100C (Plastic)

▶ STANDARD ACCESSORIES

- Plastic case (MPP-18, MPP-10)
- Soft case (MPP-12)

PRODUCT NAME	MODEL	PKG QTY	MOQ	CODE NO.	C/O
DM Pin Pole / 1,800mm (600×3)	MPP-18	5	5	219522	JP
Case for MPP-18	MPP-C	-	5	219714	CN
DM Pin Pole / 1,250mm (300×3, 350×1)	MPP-12	5	5	219941	JP
Case for MPP-12	MPP-SC	-	5	219943	CN
DM Pin Pole / 1,000mm (1000×1)	MPP-10	5	5	219940	JP
Case for MPP-10	MPP-100C	-	5	219942	CN
Shoe for DM Pin Pole	DMP-50	-	5	101919	CN

DM Pin Pole

DMP series

ROBUST JOINT

All of DM Pin Poles have robust joint structure with high straight accuracy.



DMP-9

DMP-9MINI

DMP-9/20

▶ POLE DIAMETER

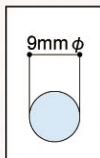

▶ ROBUST JOINT

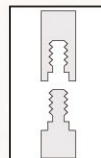

CHECK

ROBUST JOINT STRUCTURE

All joint type DM Pin Poles have "Robust Joint Structure". By making joint point thick, it brings high straight accuracy and break-proof.

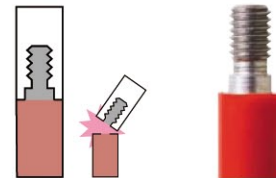

▶ SPECIFICATIONS

Model	DMP-9	DMP-9MINI	DMP-9/20
Full extended	1,500mm	1,500mm	800mm
Section	500mm / 3 sec.	300mm / 5 sec.	200mm / 4 sec.
Material	Stainless	Stainless	Stainless
Color interval	50mm interval	50mm interval	50mm interval
Case	DMP-C(Aluminium)	Fabric	Artificial leather

PRODUCT NAME	MODEL	PKG QTY	MOQ	CODE NO.	C/O
DM Pin Pole / 1,500mm (500×3)	DMP-9	10	10	101915	CN
Aluminium Case for DMP-9	DMP-C	-	5	212820	CN
DM Pin Pole / 1,500mm (300×5)	DMP-9MINI	10	10	032025	CN
DM Pin Pole / 800mm (200×4)	DMP-9/20	10	10	219339	CN
Shoe for DM Pin Pole	DMP-50	-	5	101919	CN
Shoe for DM Pin Pole (Female)	DMP-M6	-	5	219524	CN



Product Link

2.5 inch Prism

MG2.5 series



EYE SCOPE & TILTING

It is easy to aim direction from prism side with EYE SCOPE & TILTING.



MG-2500S (Traverse kit)

SC-2500S
(Soft case set)



MG-2500SP (Prism target set)

SPECIFICATIONS

Model	MG-2500S (P)	MG-2500G (P)
Prism size	2.5inch (63.5mm)	2.5inch (63.5mm)
Prism constant	0mm	0mm
Beam deviation	5" - 6"	5" - 6"
Prism coating	Silver	Silver

PRODUCT NAME	MODEL	PKG QTY	MOQ	CODE NO.	C/O
2.5inch Prism / Yellow / Traverse Kit	MG-2500S	2	10	217900	CN
2.5inch Prism / Yellow / Soft case set	SC-2500S	2	10	240030	CN
2.5inch Prism / Gray / Traverse Kit	MG-2500G	2	10	217901	CN
2.5inch Prism / Yellow / Prism Target Set	MG-2500SP	10	10	217902	CN
2.5inch Prism / Gray / Prism Target Set	MG-2500GP	10	10	217903	CN

CHECK



Silver coat

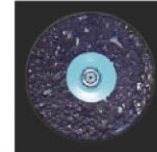

Bright field of view
(Optical plummet)



Prism constant

PACKAGE

Traverse kit

: Prism target set, Tribrach set (MG030:Ref. Page 039), Adjustment tools, Hard case

Soft case set

: Prism target set, Tribrach set (MG030:Ref. Page 039), Adjustment tools, Soft case

Prism target set (with soft case)

: Prism, Target & Holder set for pole use



Product Link

2.5 inch Prism

PG2.5 series



VIVID COLOR

PG series has vivid color targets to be found easily.



PG-2500G (Traverse kit)



PG-2500GP (Prism target set)

SPECIFICATIONS

Model	PG-2500S (P)	PG-2500G (P)
Prism size	2.5inch (63.5mm)	2.5inch (63.5mm)
Prism constant	0 / -30mm	0 / -30mm
Beam deviation	5" - 6"	5" - 6"
Prism coating	Silver	Silver

PRODUCT NAME	MODEL	PKG QTY	MOQ	CODE NO.	C/O
2.5inch Prism / Yellow / Traverse Kit	PG-2500S	2	10	218441	CN
2.5inch Prism / Gray / Traverse Kit	PG-2500G	2	10	218442	CN
2.5inch Prism / Yellow / Prism Target Set	PG-2500SP	10	10	217950	CN
2.5inch Prism / Gray / Prism Target Set	PG-2500GP	10	10	217938	CN

CHECK



Silver coat

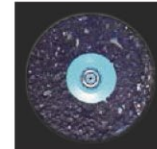

Bright field of view
(Optical plummet)



Prism constant

PACKAGE

Traverse kit (with carrying case)

: Prism target set, Tribrach set (MG030:Ref. Page 039), Adjustment tools

Prism target set (with soft case)

: Prism, Target & Holder set for pole use



Product Link

2.5 inch Prism

SG2.5 series



2 TYPES PRISM CONSTANT

SG series has 2 types of Prism Constant, 0mm / 30mm.



SG-2500G (Traverse kit)



SG-2500GP (Prism target set)

► SPECIFICATIONS

Model	SG-2500S (P)	SG-2500G (P)
Prism size	2.5inch (63.5mm)	2.5inch (63.5mm)
Prism constant	0 / -30mm	0 / -30mm
Beam deviation	5" - 6"	5" - 6"
Prism coating	Silver	Silver

PRODUCT NAME	MODEL	PKG QTY	MOQ	CODE NO.	C/O
2.5inch Prism / Yellow / Traverse Kit	SG-2500S	2	10	222290	CN
2.5inch Prism / Gray / Traverse Kit	SG-2500G	2	10	222289	CN
2.5inch Prism / Yellow / Prism Target Set	SG-2500SP	10	10	-	CN
2.5inch Prism / Gray / Prism Target Set	SG-2500GP	10	10	217944	CN
Prism & Holder set for SG-2500SP	MY201SHP	-	2	222273	CN
Target for SG-2500SP	MY201ST	-	2	222272	CN

✓ CHECK



Silver coat

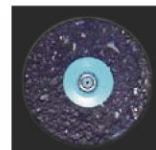

Bright field of view (Optical plummet)



Prism constant

► PACKAGE

Traverse kit (with carrying case)

: Prism target set, Tribrach set (MG030:Ref. Page 039), Adjustment tools

Prism target set (with soft case)

: Prism, Target & Holder set for pole use



Product Link

2.5 inch Triple Prism

TG2.5 series



TRIPLE PRISM

Triple prisms are easy to be found and aimed.



TG-2500G (Traverse kit)



TG-2500GP (Prism target set)

► SPECIFICATIONS

Model	TG-2500S (P)	TG-2500G (P)
Prism size	2.5inch (63.5mm)	2.5inch (63.5mm)
Prism constant	0 / -30mm	0 / -30mm
Beam deviation	5" - 6"	5" - 6"
Prism coating	Silver	Silver

PRODUCT NAME	MODEL	PKG QTY	MOQ	CODE NO.	C/O
2.5inch Prism / Yellow / Traverse Kit	TG-2500S	2	10	217904	CN
2.5inch Prism / Gray / Traverse Kit	TG-2500G	2	10	217905	CN
2.5inch Prism / Yellow / Prism Target Set	TG-2500SP	10	10	240038	CN
2.5inch Prism / Gray / Prism Target Set	TG-2500GP	10	10	240029	CN

✓ CHECK



Silver coat

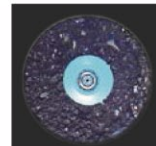

Bright field of view (Optical plummet)



Prism constant

► PACKAGE

Traverse kit (with carrying case)

: Prism target set, Tribrach set (MG030:Ref. Page 039), Adjustment tools

Prism target set (with soft case)

: Prism, Target & Holder set for pole use

Tribrach & Height Adapter

MG030 series

HIGH VISIBILITY

MG030 series has high brightness & center circle of view from optical plummet.



MG030S



Scale of height adapter



MG030G

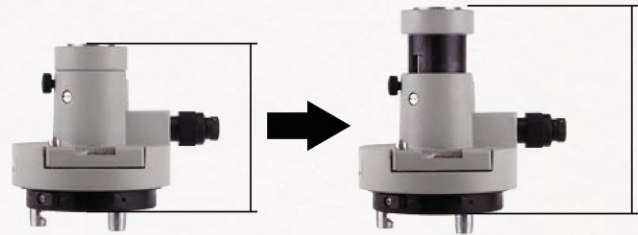

Full closed : 98mm

Full extended : 121mm

Height adjustable : 23mm

✓ CHECK

HIGH VISIBILITY

The view from optical plummet is bright, and there is a center circle. It's easy to aim measuring point by brightness, and set measuring at measuring point exactly.

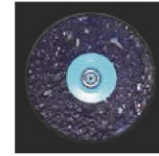

PRODUCT NAME	MODEL	PKG QTY	MOQ	CODE NO.	C/O
Tribrach & Height Adapter / Yellow	MG030S	6	6	219324	CN
Tribrach & Height Adapter / Gray	MG030G	6	6	217907	CN
Adapter for Tribrach	5/8 inch Adapter	-	10	221340	CN

► SPECIFICATIONS

	MG030S	MG030G
Model	MG030S	MG030G
Adjustable range	23mm	23mm
Circular level	8' / 2mm	8' / 2mm
Tubular level	60" / 2mm	60" / 2mm



Product Link

NEW Tribrach with Optical Plummet MY011BO / YO

CLEAR & EASY ADJUSTMENT

Available to use for GNSS instruments



MY011BO



MY011YO

► SPECIFICATIONS

Material	: Aluminium
Plummet	: Optical
Circular level	: 8' / 2mm
Color	: Yellow / Black
Locking screw	: 5/8 inch female

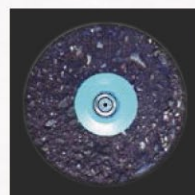

Bright field of view (Optical plummet)

PRODUCT NAME	MODEL	PKG QTY	MOQ	CODE NO.	C/O
Tribrach with Optical Plummet / Black	MY011BO	1	10	240003	CN
Tribrach with Optical Plummet / Yellow	MY011YO	1	10	222271	CN

NEW Spigot type Pole Adapter LSP100

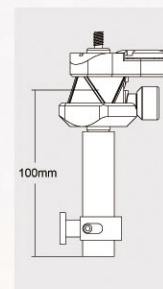

► SPECIFICATIONS

Size	: 25 x 27 x 135mm
Weight	: 74g

PRODUCT NAME	MODEL	PKG QTY	MOQ	CODE NO.	C/O
Spigot type Pole Adapter	LSP100	1	10	222281	CN

NEW Mini Prism Adapter MAG50



MAG50 + Z-220 + Instrument



MAG50 + DMP-M6

► SPECIFICATIONS

Pole length	: 60mm
Pole diameter	: 9mm φ
Screw	: 5/8 inch female
Use with tribrach	: Yes

PRODUCT NAME	MODEL	PKG QTY	MOQ	CODE NO.	C/O
Mini Prism Adapter	MAG50	1	10	221851	CN
Shoe / female	DMP-M6	-	5	219524	JP

Mini Prism Adapter

MAG series

UPSIDE-DOWN

This adapter open up new possibility for your surveying.

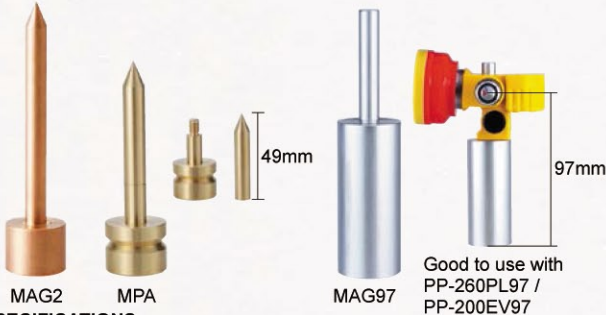

SPECIFICATIONS

Model	MAG2	MPA	MAG97
Pole length	95mm	65mm	48mm
Pole diameter	9mm φ	9mm φ	9mm φ
Screw	5/8 inch female	5/8 inch female	5/8 inch female
Use with tribrach	YES	YES	NO

CHECK

UPSIDE-DOWN USING

MAG series enable to use mini prism with prism pole. When setting prism pole as upside-down, mini prism will be close to ground.



PRODUCT NAME	MODEL	PKG QTY	MOQ	CODE NO.	C/O
Mini Prism Adapter / 95mm / Connectable to tribrach	MAG2	1	10	219313	CN
Mini Prism Adapter / 65mm / Connectable to tribrach	MPA	1	10	219523	CN
Mini Prism Adapter / 97mm offset	MAG97	1	10	240043	CN

Prism with Holder

Prism Canisters

PRISM COATING

Myzox Prism gets the best out of the instrument.



SPECIFICATIONS

Model	MG-2504S	MG-2504R	MG-1504Y
Prism size	2.5 inch (63.5mm)	2.5 inch (63.5mm)	1.5 inch (38mm)
Beam deviation	5°- 6°	5°- 6°	5°
Prism coating	Silver	Silver	Silver

Model	MG-1504B	MG-1004B	M-704R
Prism size	1.5 inch (38mm)	1.0 inch (25mm)	0.7 inch (18mm)
Beam deviation	5°	5°	5°
Prism coating	Silver	Silver	Silver

PRODUCT NAME	MODEL	PKG QTY	MOQ	CODE NO.	C/O
2.5inch Prism / Yellow-Black	MG-2504S	1	10	217910	CN
2.5inch Prism / Orange-Black	MG-2504R	1	10	219328	CN
1.5inch Prism / Orange-Yellow	MG-1504Y	1	10	212514	CN
1.5inch Prism / Orange-Black	MG-1504B	1	10	213093	CN
1.0inch Prism / Black-Black	MG-1004B	1	10	215820	CN
0.7inch Prism / Silver-Red	M-704R	1	10	219893	JP

Prism Pole 2.6 Meter

PP-260 series

SCREW LOCK

PP-260 series has a screw lock system. The screw clamp can lock tight easily.



PRODUCT NAME	MODEL	PKG QTY	MOQ	CODE NO.	C/O
Prism Pole	PP-260	10	10	500264	CN
Prism Pole (Prism height off set)	PP-260PL97	10	10	219321	CN

CHECK

PRISM HEIGHT GRADUATION

PP-260PL97 indicates prism center height from measuring points. Because pole graduation of PP-260PL97 includes prism center height of Myzox 2.5 inch prism target. (97mm)

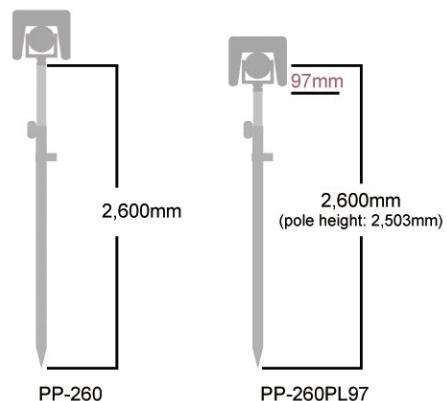

SPECIFICATIONS

Model	PP-260	PP-260PL97
Full extended	2,600mm	2,503mm
Full closed	1,480mm	1,483mm
Screw	5/8 inch male	5/8 inch male
Weight	1.20kg	1.20kg
Color interval	1 ft interval	1 ft interval
Section	2.6m / 2 sec.	2.6m / 2 sec.

STANDARD ACCESSORIES

- Case



Product Link

NEW **Survey Wall Point Plug**
SPP-40

RELOCATABLE

Adapters with monitoring prisms are relocatable.



SPP-40



SPI-M8



TTA-M8



SPECIFICATIONS

Model	SPP-40	SPI-M8	TTA-M8
Screw(Top)	M8 Female	Spigot	M10 Female
Screw(Bottom)	Anchor	M8 Male	M8 Male

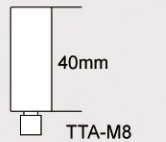
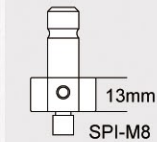

PRODUCT NAME	MODEL	PKG QTY	MOQ	CODE NO.	C/O
Survey Wall Point Plug	SPP-40	1	10	222276	CN
Adapter for Leica Spigot	SPI-M8	1	10	222277	CN
Adapter for M10 male screw	TTA-M8	1	10	222343	CN

NEW **2.5 inch Monitoring Base Kit**
TT-41

BIG MONITORING PRISM

TT-41 is suitable for long monitoring such as dams.



TT-41

+1 OPTION

Rain Cover for MG-2504R/S



RC-25

STANDARD ACCESSORIES

- Base mount
- Anchor bolt
- * Prism canister is not included.

CHECK

TT-41 is a nodal prism. Surveying Prisms and holders that are not nodal prisms can cause angular errors, if it is not perfectly pointed toward the measuring instrument.

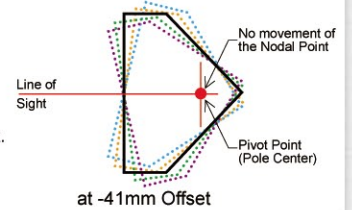

PRODUCT NAME	MODEL	PKG QTY	MOQ	CODE NO.	C/O
2.5 inch Monitoring Base Kit	TT-41	1	10	222256	CN
Rain Cover for 2.5 inch prism	RC-25	1	10	222257	CN

LED Flashing Prism Target

LED30

HIGH VISIBILITY BY LED FLASHING

LED30 has 4 LED lights on the prism target. It's useful to use at night works, mining site and long distance works and so on.



Shock proof



Water proof IP54



Prism constant -30mm



Standard accessory LA-0



Prism constant 0mm

CHECK

LED FLASHING

LED30 helps at night works, mining site or long distance works and so on. Because LED lights indicate clearly where the prism is by its flashing.

It's easy to change the brightness and frequency by switching the button at back side of prism target.

Selection of Brightness : 100%, 70%, 40%, 20%

Frequency of Flashing : 1hz, 3hz, 6hz, and lighting

* When setting as prism constant 0, it must be used with the attached adapter, LA-0.

SPECIFICATIONS

Model	LED30P	LED30
Prism constant	0 / -30mm	0 / -30mm
2.5 inch prism	Included	Not Included
Operating time (flashing)	40 hours	40 hours
Operating time (lighting)	80 hours	80 hours
Battery	AAA battery x 2	AAA battery x 2
Size (LED30 target)	178 x 178 x 50mm	178 x 178 x 50mm

CONTENTS

- LED flashing target
- Prism (MG-2504R) *LED30P only
- Adapter (LA-0)
- Screwdriver
- Battery
- Manual
- Carrying case



Product Link

PRODUCT NAME	MODEL	PKG QTY	MOQ	CODE NO.	C/O
LED Flashing Prism Target with 2.5inch Prism	LED30P	1	10	240021	TW
LED Flashing Prism Target without 2.5inch Prism	LED30	1	10	219394	TW

NEW **Monitoring Prism**
Monitoring Prisms

WATER RESISTANCE

Myzox monitoring prisms are water resistance, so they can use for a long term.

Anchor type / L-bar



TK-10S / High Visibility

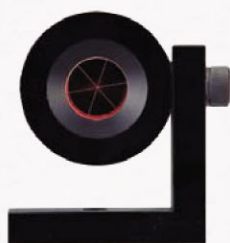

TK-10

- **Features**
- Adjustable a direction of prism in X & Y axis easily
 - Prism anti-drop mechanism
 - High cost performance

CHECK

WATER RESISTANCE

Myzox monitoring prisms are water resistance. They have resistance structure against water with sealing. Myzox monitoring prisms can be used for a long term at monitoring site.



Nodal Prism / Anchor type



TT-17



TT-27



TT-0

- **Features**
- Adjustable a direction of prism in X & Y axis easily
 - Selectable the best mach size by monitoring distance
 - Japan made
 - Anchor bolt is in the set (Length : 70mm , 14mm φ)

CHECK

TT-17 & TT-27 is a nodal prism. Surveying Prisms and holders that are not nodal prisms can cause angular errors, if it is not perfectly pointed toward the measuring instrument. To reduce pointing errors, TT-17 & TT-27 are designed with a nodal point alignment at -17mm or -27mm.

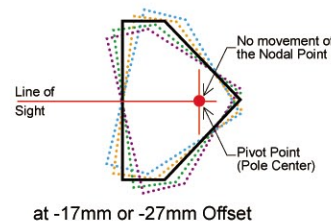

Magnet mount type



- **Features**
- Easy to use reflective target
 - Magnet can be directly affixed to point
 - 360 degree rotatable
 - Japan made

CHECK

Specialized for shipbuilding

The reflective surface rotates to a full 360 degree on a single center to allow measurement from any direction. It's suitable for measuring the datum point or the connecting points.



CHECK

Any surface conditions available

The prism sticker might not be adhered on textured or oily surfaces. As long as the objective is magnetic, even if it's oily surface, TT-0M can be used on any conditions.

► **SPECIFICATIONS**

Model	TK-10S	TK-10	TT-17	TT-27	TT-0	TT-0M
Prism size	1 inch (25mm)	1 inch (25mm)	1 inch (25mm)	1.5 inch (38mm)	47 x 47mm	47 x 47mm
Prism constant	-25mm	-25mm	-17mm	-27mm	0mm	0mm
Prism height	-	-	57mm	60mm	60mm	75mm
Beam deviation	5"	5"	5"	5"	-	-
Size	H90 x W86.5 x D30mm	H90 x W86.5 x D30mm	H87.45 x W50 x D26mm	H98.5 x W66 x D33.7mm	H95.5 x W68 x D22mm	-
Weight	207g	207g	130g (w/o anchor bolt)	260g (w/o anchor bolt)	120g (w/o anchor bolt)	240g (with magnet)

► **STANDARD ACCESSORIES**

- Anchor bolt (TT-17 / TT-27 / TT-0)
- * TK-10S, TK-10 and TT-0M : No anchor bolt

PRODUCT NAME	MODEL	PKG QTY	MOQ	CODE NO.	C/O
Monitoring Prism / 1inch / L-bar / High Visibility	TK-10S	1	10	221437	CN
Monitoring Prism / 1inch / L-bar	TK-10	1	10	219306	CN
Monitoring Prism / 1inch / Nodal Prism	TT-17	1	10	218459	JP
Monitoring Prism / 1.5inch / Nodal Prism	TT-27	1	10	218460	JP
Monitoring Prism / 47x47mm	TT-0	1	10	218461	JP
Monitoring Prism / 47x47mm / Magnet mount	TT-0M	1	10	221835	JP



Prism Sheet

Prism Sheet

SIMPLE PRISM

Just put for surveying.

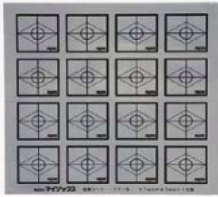

TT-S

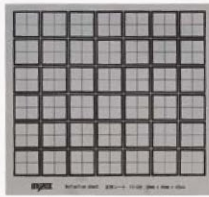

TT-S30

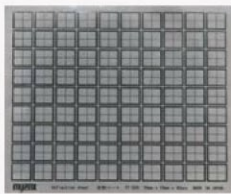

TT-S20

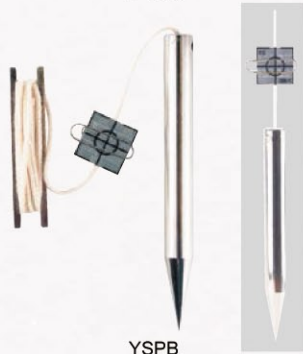

YSPB

PRODUCT NAME	MODEL	PKG QTY	MOQ	CODE NO.	C/O
Prism Sheet / 47x47mm	TT-S	-	10	218458	JP
Prism Sheet / 30x30mm	TT-S30	-	10	219265	JP
Prism Sheet / 20x20mm	TT-S20	-	10	219389	JP
Plumb Bob with Prism Sheet	YSPB	-	10	221117	JP

✓ CHECK

SIMPLE PRISM

Prism sheet is simple adhesive reflection sheet. It's most suitable to use as simple prism at simple working site. Measuring range is from 5m to 100m.
*The measuring range depends on spec of instruments, and environment such as humidity or temperature and so on.

✓ CHECK

WITH PLUMB BOB (YSPB)

By using plumb bob instead of pole, there is no doubt about its verticality.

▶ SPECIFICATIONS

Model	TT-S	TT-S30	TT-S20	YSPB
Size (sheet)	250 x 250mm	250 x 250mm	250 x 250mm	20 x 20mm
Size (pc)	47 x 47mm	30 x 30mm	20 x 20mm	20 x 20mm
Quantity	16pcs	42pcs	90pcs	-
Prism constant	0mm	0mm	0mm	-
Weight	-	-	-	95g

▶ STANDARD ACCESSORIES (YSPB)

- String (145cm)
- Prism sheet
- Metal piece to wind the string



Product Link

Prism Adapter

Measuring Probe C

MOUNTING ON DM PIN POLE

Useful for setting the prism against wall.



▶ SPECIFICATIONS

Suitable prism :
Myzox 1.5 inch Prism (MG-1504Y, MG-1504B)
Prism constant : 0mm

PRODUCT NAME	MODEL	PKG QTY	MOQ	CODE NO.	C/O
Prism Adapter	Measuring Probe C	-	10	210792	CN

Prism Cushion Case

PR-C series

EASY CARRYING

Don't exhaust yourself before surveying.



PR-C

✓ CHECK

EASY CARRYING

PR-C can store mini prism, mini prism tripod and DM pin poles together. PR-C & PR-CS help to carry accessories with good portability.

2.5inch Prism Soft Case

M-TPC

SIMPLE CASE

It's light-weight to carry around.



Good for Myzox 2.5 inch Prism

▶ SPECIFICATIONS

Size : W220 x H365 x D180mm
Weight : 365g



Product Link

PRODUCT NAME	MODEL	PKG QTY	MOQ	CODE NO.	C/O
2.5inch Prism Soft Case	M-TPC	2	10	219945	CN

▶ SPECIFICATIONS

Model	PR-C	PR-CS
Size	800 x 220 x 30mm	705 x 185 x 40mm

▶ REMARKS

- PR-C : Case for mini prism, Mini prism tripod (MPPS2), DM pin poles
- PR-CS : Case for mini prism, DM pin poles



Product Link

PRODUCT NAME	MODEL	PKG QTY	MOQ	CODE NO.	C/O
Prism Cushion Case	PR-C	-	10	217358	CN
Prism Cushion Case	PR-CS	-	10	219267	CN

Mini Prism Adapter

MP-A

VARIOUS SCENES

MP-A expands the possibility of your surveying.

For MG-1500MP2 / MG-1500GP2 / MG-1000SP / M-1000MP



Prism Adapter

Bracket C

Bracket D

Bracket E



for Side use
(Prism Adapter)

for Self-Stand
(Prism Adapter & Bracket C & E)

for Pole use
(Prism Adapter & Bracket D & E)

► CONTENTS (MP-A)

- Bracket C
- Bracket D
- Bracket E
- Prism Adapter
- Soft case

PRODUCT NAME	MODEL	PKG QTY	MOQ	CODE NO.	C/O
Mini Prism Accessory Set	MP-A	-	5	031070	JP
Mini Prism Accessory	Prism Adapter	-	10	218911	JP
Mini Prism Accessory	Bracket C	-	10	218908	JP
Mini Prism Accessory	Bracket D	-	10	218909	JP
Mini Prism Accessory	Bracket E	-	10	218910	JP

Prism Adapter for MG-1500SL

SL-A

VARIOUS USING

SL-A expands the possibility of your surveying.

For MG-1500SL



Bracket A

Bracket B

Measuring Probe A

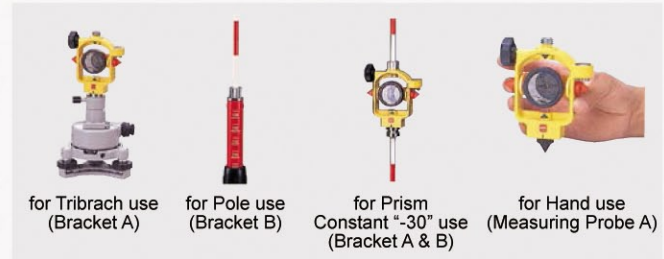

for Tribrach use
(Bracket A)

for Pole use
(Bracket B)

for Prism
Constant "-30" use
(Bracket A & B)

for Hand use
(Measuring Probe A)

► CONTENTS (SL-A)

- Bracket A
- Bracket B
- Measuring Probe A
- Soft case

PRODUCT NAME	MODEL	PKG QTY	MOQ	CODE NO.	C/O
Mini Prism Accessory Set	SL-A	-	5	031071	JP
Mini Prism Accessory	Bracket A	-	10	10245704	JP
Mini Prism Accessory	Bracket B	-	10	10245705	JP
Mini Prism Accessory	Measuring Probe A	-	10	218907	JP

Prism Adapter for Pole

M-Adapter



► SPECIFICATIONS
Clip range : 34mm

Product Link

PRODUCT NAME	MODEL	PKG QTY	MOQ	CODE NO.	C/O
Prism Adapter	M-Adapter	-	10	102453	JP

Prism Adapter for Pole

T-Adapter



► SPECIFICATIONS
Weight : 160g
Female screw : 5/8 inch

Product Link

PRODUCT NAME	MODEL	PKG QTY	MOQ	CODE NO.	C/O
Prism Adapter for pole	T-Adapter	-	10	102518	JP

Prism Adapter for Tribrach

Brackets

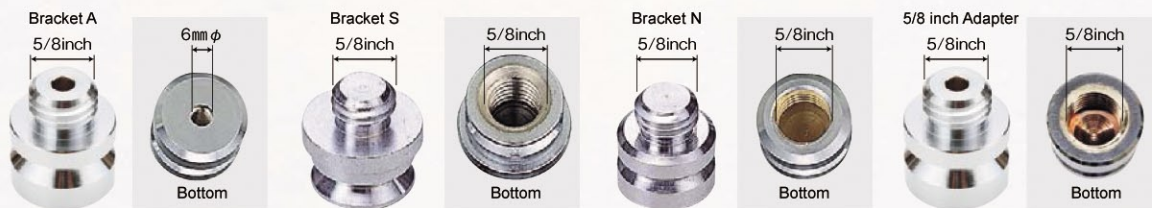

PRODUCT NAME	MODEL	PKG QTY	MOQ	CODE NO.	C/O
Adapter for Tribrach	Bracket A	-	10	10245704	JP
Adapter for Tribrach	Bracket S	-	10	102455	JP
Adapter for Tribrach	Bracket N	-	10	102456	JP
Adapter for Tribrach	5/8 inch Adapter	-	10	221340	CN

► SPECIFICATIONS

Model	BRACKET A	BRACKET S	BRACKET N	5/8 inch Adapter
Male screw	5/8 inch	5/8 inch	5/8 inch	5/8 inch
Female screw	6mm φ	5/8 inch	5/8 inch	5/8 inch
Size	Dφ25×H 20mm	Dφ25×H 18mm	Dφ24.5×H 17.5mm	Dφ25×H 20mm



Product Link



03 POLE

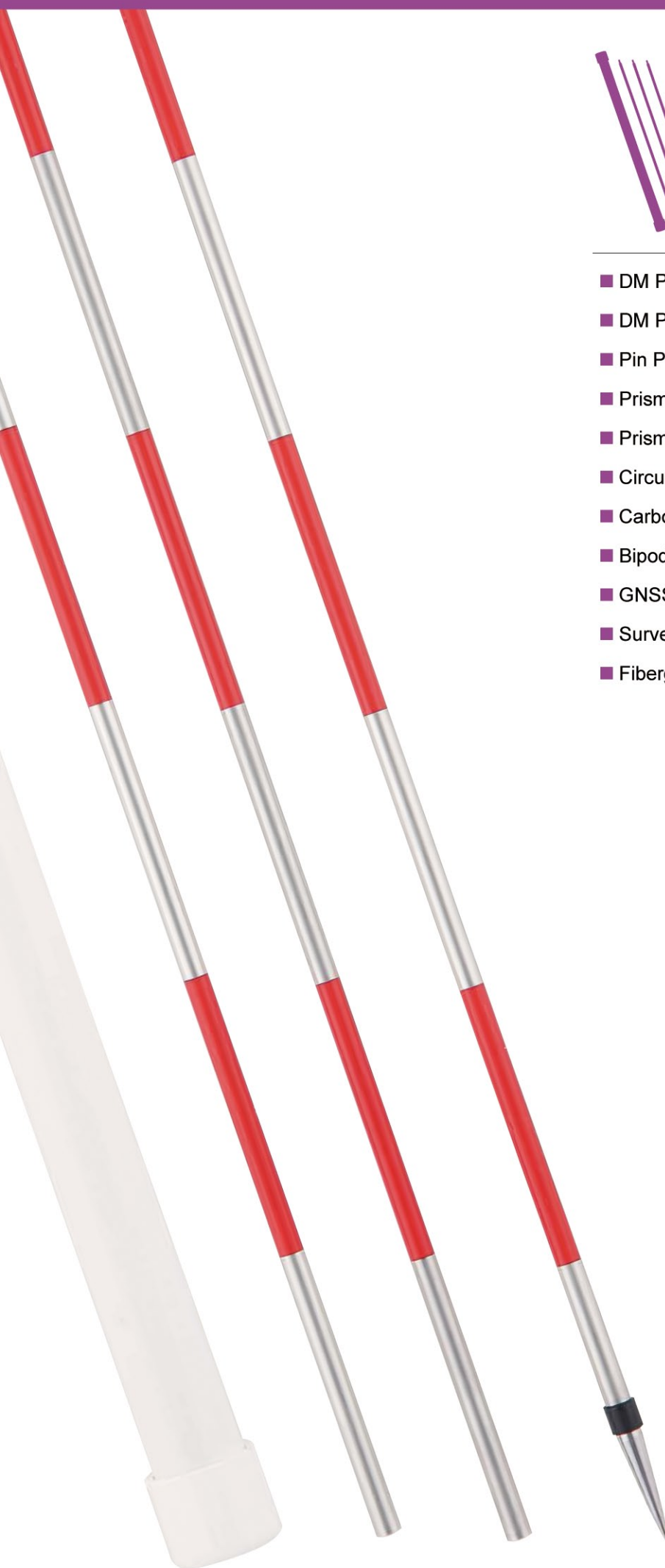

- DM Pin Pole Colorfast type P046
- DM Pin Pole P047
- Pin Pole Shoe / Pole Accessory P048
- Prism Pole Tripod / Prism Adapter P049
- Prism Pole P050
- Circular Level P052
- Carbonfiber Pole P053
- Bipod P054
- GNSS Pole P055
- Surveying Pole / Pole Stand P056
- Fiberglass Measuring Pole P057



TRIPOD	1
PRISM	2
POLE	3
STAFF	4
GNSS ACCESSORY	5
SURVEYING / LASER INSTRUMENT	6
SURVEYING ACCESSORY	7
MEASURING TOOL	8
TESTING INSTRUMENT	9
SECURITY GOODS	10

DM Pin Pole Colorfast type

MPP series

COLORFAST

MPP series has colorfast structure by resin, never peel off the color by sliding prisms.

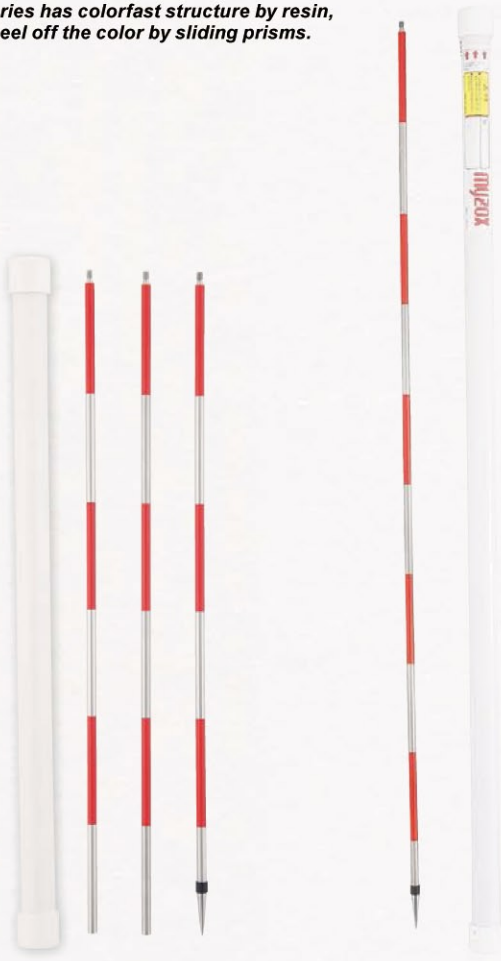

MPP-18

MPP-10



MPP-12

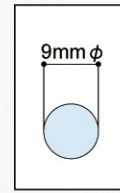

Pole Diameter

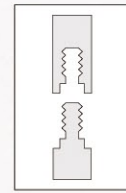

Robust Joint
(Ref. Page 047)

✓ CHECK

COLORFAST STRUCTURE (PAT.P)

Red parts are made of resin to maintain the color. When sliding prisms on DM pin poles, conventional pole will lose color. But MPP series use 1mm thick resin to avoid losing color.

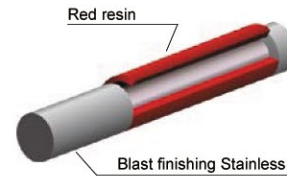

Red resin is looped around the stainless.



Blast finishing prevents the reflection of light.

✓ CHECK

HIGH STRAIGHTNESS (MPP-10)

MPP-10 is single section model. It is preferred for the reason that single section keep the straightness accuracy. Sometimes, length of MPP-10 is the problem to carry around. In that case, we recommend MPP-18 which has robust joint structure.

Passing mark

within 0.3mm at 300mm

► SPECIFICATIONS

Model	MPP-18	MPP-12	MPP-10
Full extended	1,800mm	1,250mm	1,000mm
Section	600mm x 3 sec.	300mm x 3 sec. 350mm x 1 sec.	1,000mm x 1 sec.
Material	Stainless & resin	Stainless & resin	Stainless & resin
Color interval	100mm interval	50mm interval	100mm interval
Case	MPP-C (Plastic)	MPP-SC (Fabric)	MPP-100C (Plastic)

► STANDARD ACCESSORIES

- Plastic case (MPP-18, MPP-10)
- Soft case (MPP-12)

PRODUCT NAME	MODEL	Pkg QTY	MOQ	CODE NO.	C/O
DM Pin Pole / 1,800mm(600x3)	MPP-18	5	5	219522	JP
Case for MPP-18	MPP-C	-	5	219714	CN
DM Pin Pole / 1,250mm(300x3, 350x1)	MPP-12	5	5	219941	JP
Case for MPP-12	MPP-SC	-	5	219943	CN
DM Pin Pole / 1,000mm(1000x1)	MPP-10	5	5	219940	JP
Case for MPP-10	MPP-100C	-	5	219942	CN
Shoe for DM Pin Pole	DMP-50	-	5	101919	CN

DM Pin Pole

DMP series

ROBUST JOINT

All of DM Pin Poles have robust joint structure with high straight accuracy.



DMP-9

DMP-9MINI

DMP-9/20

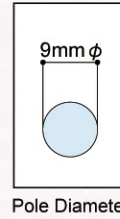

Pole Diameter

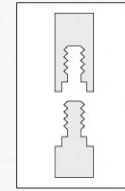

Robust Joint

✓ CHECK

ROBUST JOINT STRUCTURE

All joint type DM Pin Poles have "Robust Joint Structure". By making joint point thick, it brings high straight accuracy and break-proof.

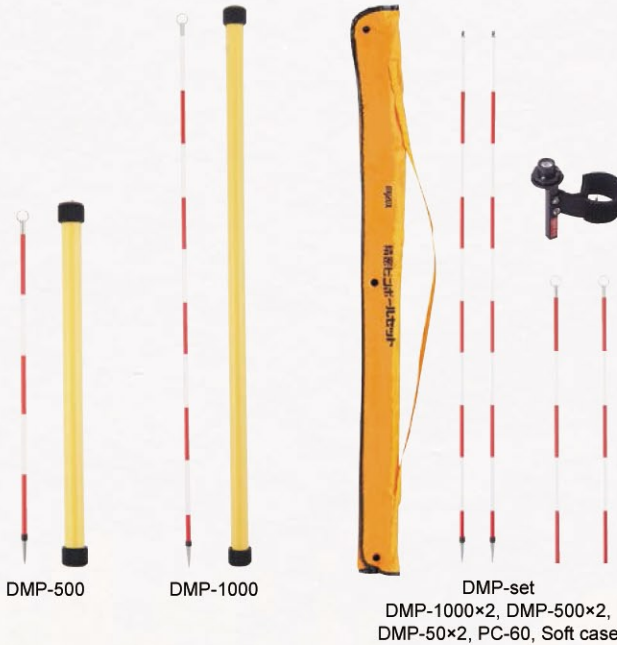
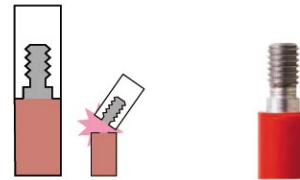

DMP-500

DMP-1000

DMP-set

DMP-1000×2, DMP-500×2, DMP-50×2, PC-60, Soft case

✓ CHECK

ANTI-DROP STOPPER

Shoe (DMP-50) has black ring. The ring works as stopper for prisms. "Anti-drop Stopper System"

(PAT.P)

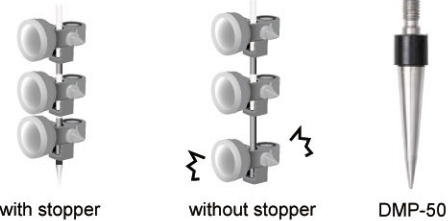

with stopper

without stopper

DMP-50

► SPECIFICATIONS

Model	DMP-9	DMP-9MINI	DMP-9/20	DMP-1500	DMP-1200	DMP-1000	DMP-500
Full extended	1,500mm	1,500mm	800mm	1,500mm	1,200mm	1,000mm	500mm
Section	500mm x 3 sec.	300mm x 5 sec.	200mm x 4 sec.	1,500mm x 1 sec.	1,200mm x 1 sec.	1,000mm x 1 sec.	500mm x 1 sec.
Material	Stainless	Stainless	Stainless	Stainless	Stainless	Stainless	Stainless
Color interval	50mm interval	50mm interval	50mm interval	50mm interval	50mm interval	50mm interval	50mm interval
Case	Aluminium	Fabric	Artificial leather	Aluminium	Aluminium	Aluminium	Aluminium

Model	DMP-50	DMP-M6
Length	5cm	5cm
Screw	Male	Female
Material	Stainless	Stainless

► STANDARD ACCESSORIES

- Carrying case



Product Link

PRODUCT NAME	MODEL	PKG QTY	MOQ	CODE NO.	C/O
DM Pin Pole / 1,500mm(500×3)	DMP-9	10	10	101915	CN
DM Pin Pole / 1,500mm(300×5)	DMP-9MINI	10	10	032025	CN
DM Pin Pole / 800mm(200×4)	DMP-9/20	10	10	219339	CN
DM Pin Pole Set	DMP-set	10	10	101916	CN
DM Pin Pole / 1,500mm(1,500×1)	DMP-1500	5	5	101917	CN
DM Pin Pole / 1,200mm(1,200×1)	DMP-1200	5	5	221487	CN
DM Pin Pole / 1,000mm(1,000×1)	DMP-1000	5	5	101918	CN
DM Pin Pole / 500mm(500×1)	DMP-500	5	5	101920	CN

PRODUCT NAME	MODEL	PKG QTY	MOQ	CODE NO.	C/O
Case for DMP-9 / DMP-500	DMP-C	-	5	212820	CN
Case for DMP-9MINI	DMP-9MINI-C	-	5	221978	CN
Case for DMP-set	DMP-set-C	-	5	221982	CN
Case for DMP-1500	DMP-1500-C	-	5	221985	CN
Case for DMP-1000	DMP-1000-C	-	5	221986	CN
Shoe for DM Pin Pole	DMP-50	-	5	101919	CN
Shoe for DM Pin Pole (Female)	DMP-M6	-	5	219524	CN

TRIPOD 1
PRISM 2
POLE 3
STAFF 4
GNSS ACCESSORY 5
SURVEYING / LASER INSTRUMENT 6
SURVEYING ACCESSORY 7
MEASURING TOOL 8
TESTING INSTRUMENT 9
SECURITY GOODS 10

Shoe for DM Pin Pole

Shoe for DM Pin Pole

VARIOUS SHOES

Purpose changes, Shoe changes. Choose your favorite shoe for your work.



Product Link

✓ CHECK

Prevent the loosening of screw by tightening with wrench.



HS-50 series



HS-50 HS-R HS-50SL HS-SLR HS-50PE HS-PER DMP-50 Myzox standard type DMP-M6 Female screw YS DMP-50F DMP-50N DMP-100N

► SPECIFICATIONS

Model	HS-50	HS-R	HS-50SL	HS-SLR	HS-50PE	HS-PER	DMP-50	DMP-M6	YS	DMP-50F	DMP-50N	DMP-100N
Length	5cm	5cm	5cm	5cm	5cm	5cm	5cm	5cm	6cm	5cm	5cm	10cm
Screw	Male	Male	Male	Male	Male	Male	Male	Female	Male	Male	Male	Male
Wrench size	blue part 10	5.5	blue part 10	8	blue part 10	8	-	-	-	-	-	-

PRODUCT NAME	MODEL	PKG QTY	MOQ	CODE NO.	C/O
Shoe for DM Pin Pole (Sharp tip)	HS-50	-	5	220390	JP
Shoe for DM Pin Pole	HS-50SL	-	5	220816	JP
Shoe for DM Pin Pole (Pencil)	HS-50PE	-	5	220818	JP
Replacement tip for HS-50	HS-R	-	5	220391	JP
Replacement tip for HS-50SL	HS-SLR	-	5	220817	JP
Replacement tip for HS-50PE	HS-PER	-	5	220819	JP

PRODUCT NAME	MODEL	PKG QTY	MOQ	CODE NO.	C/O
Shoe for DM Pin Pole	DMP-50	-	5	101919	CN
Shoe for DM Pin Pole (Female)	DMP-M6	-	5	219524	CN
Shoe for DM Pin Pole (Sharp tip)	YS	-	5	210003	JP
Shoe for DM Pin Pole (Flat)	DMP-50F	-	5	219848	JP
Shoe for DM Pin Pole	DMP-50N	-	5	222263	CN
Shoe for DM Pin Pole	DMP-100N	-	5	222262	CN

Prism Cushion Case

PR-C series

EASY CARRYING

Don't exhaust yourself before surveying.

✓ CHECK

EASY CARRYING

PR-C can store mini prism, mini prism tripod and DM pin poles together. PR-C & PR-CS help to carry accessories with good portability.



PR-C



► SPECIFICATIONS

Model	PR-C	PR-CS
Size	800 x 220 x 30mm	705 x 185 x 40mm

► REMARKS

- PR-C : Case for mini prism, Mini prism tripod (MPPS2), DM pin poles
- PR-CS : Case for mini prism, DM pin poles



Product Link

PRODUCT NAME	MODEL	PKG QTY	MOQ	CODE NO.	C/O
Prism Cushion Case	PR-C	-	10	217358	CN
Prism Cushion Case	PR-CS	-	10	219267	CN

DM Pin Pole 6mm φ

DMP-6-800

FOR 360 DEGREE PRISM

Suitable for Topcon & Sokkia 360° prism

✓ CHECK

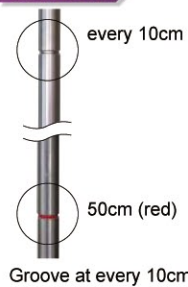

6mm screw tightening nut

► SPECIFICATIONS

Length	: 830mm
Diameter	: 6mm φ
Slide range	: 650mm
Material	: Stainless

► STANDARD ACCESSORIES

- Case



Prism height 10cm when putting the prism at the lowest point

PRODUCT NAME	MODEL	PKG QTY	MOQ	CODE NO.	C/O
DM Pin Pole 6mm φ	DMP-6-800	1	10	221552	JP
Replacement Shoe	DMP-73-M5	-	1	221863	JP

Prism Pole Tripod

PPS series

ADJUST EASILY

PPS series has different types of clamp, and every clamp makes easier to adjust pole for setting.

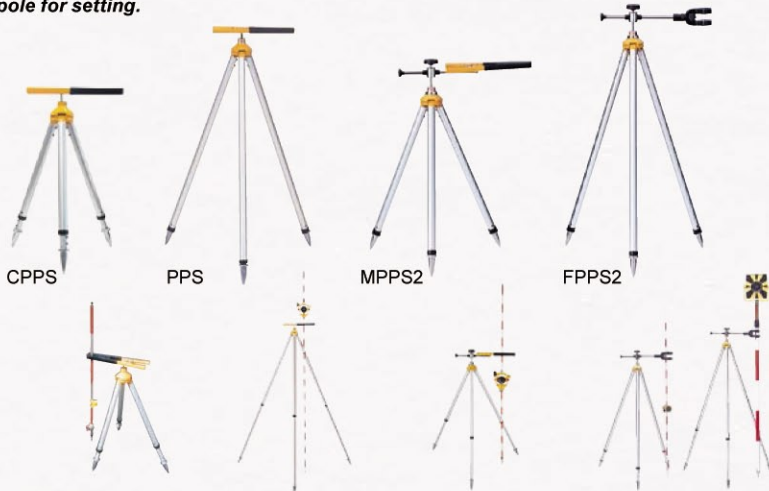

► SPECIFICATIONS

Model	CPPS	PPS	MPPS2	FPPS2
Full extended	630mm	1,230mm	900mm	1,280mm
Full closed	459mm	760mm	620mm	810mm
Weight	1.1kg	1.45kg	1.55kg	1.60kg
Head type	Scissors Clamp	Scissors Clamp	Scissors Clamp	Flexible Clamp
Slide range	-	-	140mm	150mm

PRODUCT NAME	MODEL	PKG QTY	MOQ	CODE NO.	C/O
Prism Pole Tripod / Compact	CPPS	10	10	220872	CN
Prism Pole Tripod / Standard	PPS	10	10	041021	CN
Prism Pole Tripod / Slidable arm	MPPS2	10	10	217197	CN
Prism Pole Tripod / Flexible clamp	FPPS2	10	10	217198	CN

► REMARKS

CPPS : 360° Rotating Clamp
 PPS : 360° Rotating Clamp
 MPPS2 : 360° Rotating Clamp + Sliding Arm(140mm)
 FPPS2 : Clamp Range : 25 - 30mm φ / 8 - 10mm φ

*For more details, please check Page 027



Product Link

✓ CHECK

ADJUST EASILY

The most important point of prism pole tripod is easy to set up prism poles. At the point of setting up prism poles, it's necessary to adjust circular level by adjusting prism poles and prism pole tripod.

PPS series has 360° rotating clamp or flexible clamp. Both of clamp systems bring efficient works for users.



✓ CHECK

TWIST LOCK

To extend or close the legs, it is just twist. The reason we use this locking is for efficiency.

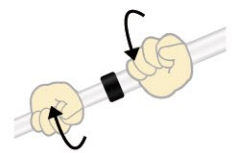

Comparing with screw lock, the withstand load may be low. But the loading from the above is not big, this locking system is enough to support the pole.

Mini Prism Adapter

MAG series

UPSIDE-DOWN

This adapter open up new possibility for your surveying.



► SPECIFICATIONS

Model	MAG2	MPA	MAG97
Pole length	95mm	65mm	48mm
Pole diameter	9mm φ	9mm φ	9mm φ
Screw	5/8 inch female	5/8 inch female	5/8 inch female
Use with tribrach	YES	YES	NO

✓ CHECK

UPSIDE-DOWN USING

MAG series enable to use mini prism with prism pole. When setting prism pole as upside-down, mini prism will be close to ground.



Product Link



Product movie

PRODUCT NAME	MODEL	PKG QTY	MOQ	CODE NO.	C/O
Mini Prism Adapter / 95mm / Connectable to tribrach	MAG2	1	10	219313	CN
Mini Prism Adapter / 65mm / Connectable to tribrach	MPA	1	10	219523	CN
Mini Prism Adapter / 97mm offset	MAG97	1	10	240043	CN

NEW Spigot type Pole Adapter LSP100

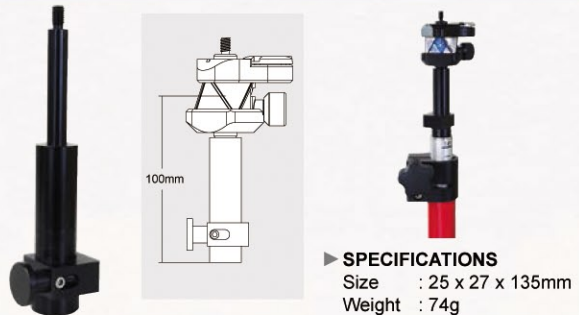

► SPECIFICATIONS

Size : 25 x 27 x 135mm
 Weight : 74g

PRODUCT NAME	MODEL	PKG QTY	MOQ	CODE NO.	C/O
Spigot type Pole Adapter	LSP100	1	10	222281	CN

NEW Mini Prism Adapter MAG50



► SPECIFICATIONS

Pole length : 60mm
 Pole diameter : 9mm φ
 Screw : 5/8 inch female
 Use with tribrach : Yes

PRODUCT NAME	MODEL	PKG QTY	MOQ	CODE NO.	C/O
Mini Prism Adapter	MAG50	1	10	221851	CN
Shoe / female	DMP-M6	-	5	219524	JP

Prism Pole Upper Extension

EV series

ALL-IN ONE

EV series is all-in one prism pole with two graduation patterns.



✓ CHECK

ALL-IN ONE

Built-in circular level :
No need to loose it at field.

GRADUATION OFFSET

97 type concern a prism height of 2500 series prisms, and is able to read actual prism height directly by graduation.

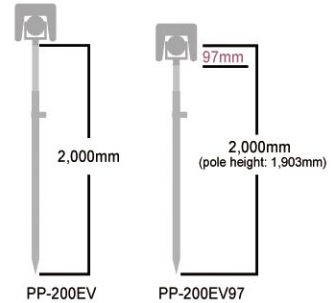

► SPECIFICATIONS

Model	PP-200EV	PP-200EV97
Full extended	2,000mm	1,903mm
Full closed	1,133mm	1,036mm
Graduation	Metric	Metric
Weight	750g	750g
Screw type	5/8 inch male	5/8 inch male
Color interval	20cm interval	20cm interval

► STANDARD ACCESSORIES

- Case



Product Link

PRODUCT NAME	MODEL	PKG QTY	MOQ	CODE NO.	C/O
Prism Pole	PP-200EV	10	10	217948	CN
Prism Pole (Prism height offset)	PP-200EV97	10	10	219345	CN
Replacement Shoe	PP-2	-	1	031015	CN

Prism Pole Upper Extension

E series

STANDARD PRISM POLE

E series is standard model of prism pole with good visibility colors.

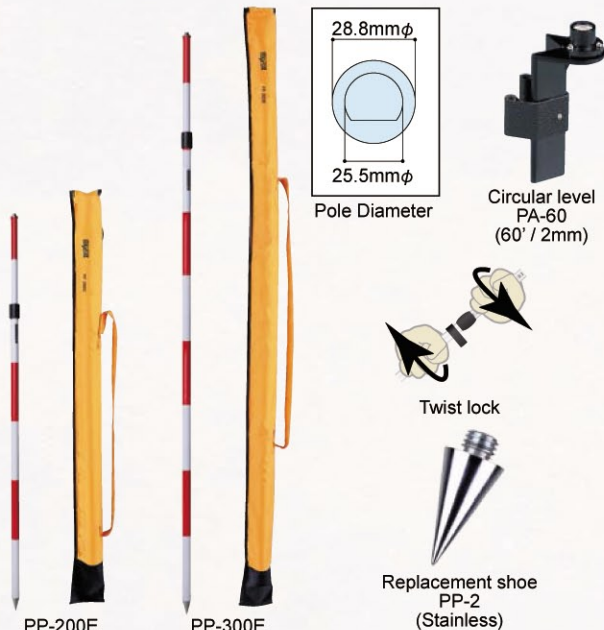

✓ CHECK

BEST SELLER

This is standard prism pole, it's big seller. Twist lock system can fix your favorite height. Detachable circular level and carrying case comes with as standard accessories.



► SPECIFICATIONS

Model	PP-200E	PP-300E
Full extended	2,000mm	3,000mm
Full closed	1,133mm	1,663mm
Graduation	Metric	Metric
Weight	750g	1,020g
Screw type	5/8 inch male	5/8 inch male
Color interval	20cm interval	20cm interval

► STANDARD ACCESSORIES

- Case
- Circular level (PA-60)



Product Link

PRODUCT NAME	MODEL	PKG QTY	MOQ	CODE NO.	C/O
Prism Pole / 2,000mm	PP-200E	10	10	031020	CN
Prism Pole / 3,000mm	PP-300E	10	10	031021	CN
Replacement Shoe	PP-2	-	1	031015	CN
Case for PP-200E	PP-200E-C	10	10	221979	CN
Case for PP-300E	PP-300E-C	10	10	221980	CN

NEW Prism Pole Lower Extension
D2 series

LOWER EXTENSION

Prism Pole D series can be extended to downward.

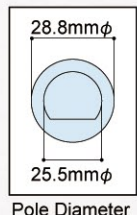
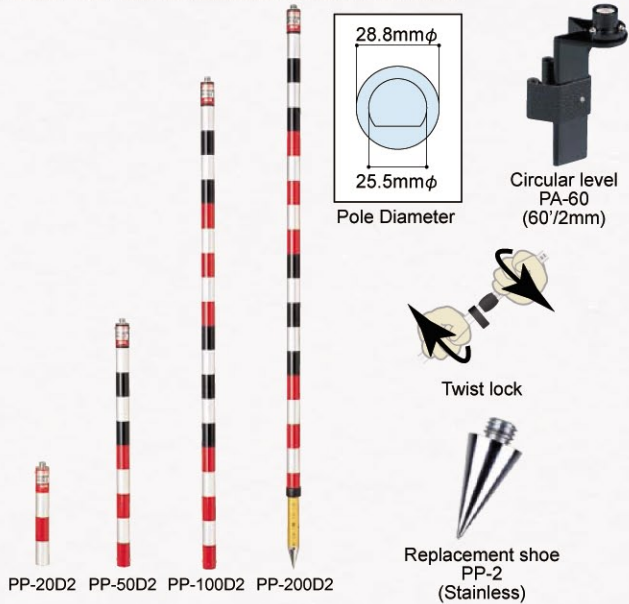

Circular level PA-60 (60/2mm)



Replacement shoe PP-2 (Stainless)

CHECK

LOWER EXTENSION

Extendable to downward. Variety of extension poles are also available. Using 3 colors to divide section and easy to find at field.



SPECIFICATIONS

Model	PP-200D2	PP-100D2	PP-50D2
Full extended	2,000mm	1,000mm	500mm
Full closed	1,152mm	-	-
Graduation	Metric	-	-
Weight	approx. 750g	approx. 300g	approx. 230g
Screw type	5/8 inch male	5/8 inch male	5/8 inch male
Color interval	10cm interval	10cm interval	10cm interval

Model	PP-20D2	PP-3	PP-2
Full extended	200mm	-	-
Full closed	-	-	-
Graduation	-	-	-
Weight	approx. 160g	-	-
Screw type	5/8 inch male	5/8 inch male	5/8 inch male
Color interval	10cm interval	-	-

STANDARD ACCESSORIES (PP-200D2)

- Case
- Circular Level (PA-60)

PRODUCT NAME	MODEL	PKG QTY	MOQ	CODE NO	C/O
Prism Pole	PP-200D2	10	10	222358	CN
Extension Pole	PP-100D2	-	1	222359	CN
Extension Pole	PP-50D2	-	1	222360	CN
Extension Pole	PP-20D2	-	1	222361	CN
Replacement Shoe for PP-200D2	PP-3	-	1	222362	CN
Replacement Shoe for PP-100/50/20D2	PP-2	-	1	031015	CN

Prism Pole Upper Extension
PP-200A2

QUICK OPERATION

Quick type Prism Pole, PP-200A2, brings good operability.

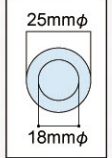

Pole Diameter

Built-in Circular Level (20' / 2mm)

Stainless shoe (Resist-rust)

Reading point

CHECK

QUICK OPERATION

Easy to extend the pole length by grabbing button, and fast to set your required height by the quick release function and graduation.



Grabbing button

SPECIFICATIONS

- Full extended : 2,074mm
- Full closed : 1,224mm
- Graduation : Metric
- Weight : 980g
- Screw : 5/8 inch adapter
- Color interval : 20cm interval

STANDARD ACCESSORIES

- Case



Product Link

PRODUCT NAME	MODEL	PKG QTY	MOQ	CODE NO.	C/O
Prism Pole	PP-200A2	10	10	220874	CN
Case for PP-200A2	PP-200A2-C	10	10	222055	CN

Prism Pole Upper Extension
PP-450

MINING / FOREST FIELD

PP-450 is suitable to use at mining and forest field.

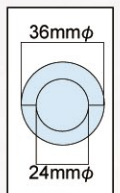

Pole Diameter

5/8 inch thread

Built-in Circular Level (40' / 2mm)

CHECK

MINING / FOREST FIELD

Suitable for forest, farm or mining fields. Easy to put prism at high-position which can be higher than tree or difference in height.

SPECIFICATIONS

- Full extended : 4,650mm
- Full closed : 1,500mm
- Screw : 5/8 inch male
- Weight : 1.85kg
- Color interval : 1 ft interval
- Section : 4.5m / 4 sec.

STANDARD ACCESSORIES

- Case



Product Link

PRODUCT NAME	MODEL	PKG QTY	MOQ	CODE NO.	C/O
Prism Pole	PP-450	10	10	218305	CN
Case for PP-450	PP-450-C	10	10	221994	CN
Replacement Shoe for PP-450	PP-3	-	1	219117	CN

Prism Pole 2.6 Meter

PP-260 series

SCREW LOCK

PP-260 series has a screw lock system. The screw clamp can lock tight easily.



Built-in Circular Level (40' / 2mm)

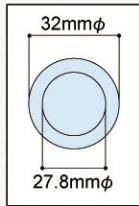

Pole Diameter



Stainless shoe (Resist-rust)



Reading point Screw lock

PRODUCT NAME	MODEL	PKG QTY	MOQ	CODE NO.	C/O
Prism Pole	PP-260	10	10	500264	CN
Prism Pole (Prism height off set)	PP-260PL97	10	10	219321	CN

CHECK

PRISM HEIGHT GRADUATION

PP-260PL97 indicates prism center height from measuring points. Because pole graduation of PP-260PL97 includes prism center height of Myzox 2.5 inch prism target. (97mm)

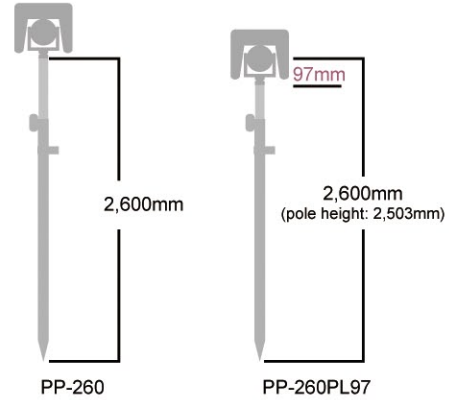

SPECIFICATIONS

Model	PP-260	PP-260PL97
Full extended	2,600mm	2,503mm
Full closed	1,480mm	1,483mm
Screw	5/8 inch male	5/8 inch male
Weight	1.20kg	1.20kg
Color interval	1 ft interval	1 ft interval
Section	2.6m / 2 sec.	2.6m / 2 sec.

STANDARD ACCESSORIES

- Case



Product Link

Circular Level for Pole

Circular Levels

WIDE RANGE

Myzox has wide range of circular levels for prism poles and DM poles.



RL-40TS (40' / 2mm)

PC-60 (60' / 2mm)

RL-60T (60' / 2mm)

PC-40L (46' / 2mm)

PH-10 (10' / 2mm)

PA-20 (20' / 2mm)

PA-40 (40' / 2mm)

PA-60 (60' / 2mm)

RL-60 (60' / 2mm)

PRODUCT NAME	MODEL	PKG QTY	MOQ	CODE NO.	C/O
Circular Level (40'/2mm) with band	RL-40TS	-	10	218860	CN
Circular Level (60'/2mm) with band	PC-60	-	10	111117	CN
Circular Level (60'/2mm) with band	RL-60T	-	10	217353	CN
Circular Level (46'/2mm)	PC-40L	-	10	220477	TW
Circular Level (10'/2mm)	PH-10	-	10	111123	JP
Circular Level (20'/2mm)	PA-20	-	10	111112	CN
Circular Level (40'/2mm)	PA-40	-	10	220943	CN
Circular Level (60'/2mm)	PA-60	-	10	111111	CN
Circular Level (60'/2mm) handheld type	RL-60	-	10	111113	CN

COMPATIBILITY TABLE

Model	DM Pin Pole	Pole (25~30mm φ)	Staff
RL-40TS	✓ (9mm φ / 6mm φ)	✓	✓
PC-60	✓ (9mm φ / 6mm φ)	✓	
RL-60T		✓	✓
PC-40L	✓ (9mm φ)		
PH-10		✓	
PA-20		✓	
PA-40		✓	
PA-60		✓	
RL-60		✓	✓



Product Link

Carbonfiber Pole Telescopic type

RCP-260

RTK SURVEY

Suitable model for RTK survey is RCP-260.



*Bipod is an optional product.

PRODUCT NAME	MODEL	PKG QTY	MOQ	CODE NO.	C/O
Carbonfiber Pole	RCP-260	10	10	500293	CN
Case for RCP-260	RCP-260-C	10	10	222165	CN
Replacement Shoe for RCP-260	RCP-1	-	1	219266	CN
Flat Shoe for RCP-260	RCP-2	-	1	221509	CN

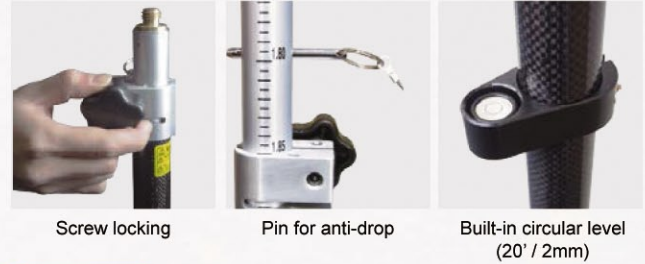

✓ CHECK

SUITABLE FOR RTK SURVEY

Durable body with an extra thickness to carbon-fiber material. The shoe is made of stainless and it is resistant to corrosion.



► SPECIFICATIONS

- Full extended : 2,600mm
- Full closed : 1,480mm
- Screw : 5/8 inch male
- Weight : 1.20kg
- Graduation : Metric (5mm)

► STANDARD ACCESSORIES

- Carrying case



Product Link

All Carbonfiber Pole Joint type

RCP-200J/300J

CARRY FRIENDLY POLE

Joint type RTK pole, carry easily.

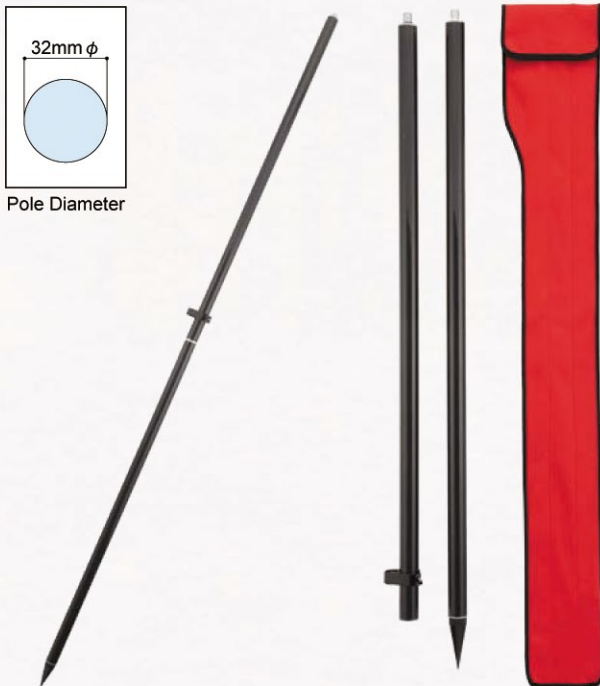

PRODUCT NAME	MODEL	PKG QTY	MOQ	CODE NO.	C/O
Carbonfiber Pole / 2,000mm	RCP-200J	10	10	219346	CN
Carbonfiber Pole / 3,000mm	RCP-300J	10	10	219377	CN



✓ CHECK

CARRY FRIENDLY POLE

Joint type RTK pole with all carbon-fiber material brings you a light and easy carrying. Easy setting and the built-in level brings a relief not to lose it at fields.



► SPECIFICATIONS

Model	RCP-200J	RCP-300J
Full extended	2,000mm	3,000mm
Section	2m / 2sec.	3m / 3sec.
Screw	5/8 inch male	5/8 inch male
Weight	650g	900g

► STANDARD ACCESSORIES

- Carrying Case



Product Link

TRIPOD 1
PRISM 2
POLE 3
STAFF 4
GNSS ACCESSORY 5
SURVEYING / LASER INSTRUMENT 6
SURVEYING ACCESSORY 7
MEASURING TOOL 8
TESTING INSTRUMENT 9
SECURITY GOODS 10

All Carbonfiber Pole Telescopic type

RCP-200T/260T

ADDITIONAL STABILITY

All carbon telescopic pole brings additional stability.



Ring lock



5/8 inch screw

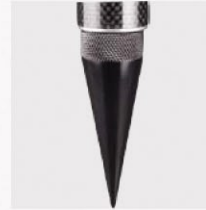

Corrosion-resistant shoe



Built-in circular level (20' / 2mm)

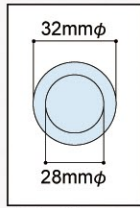

Pole Diameter

✓ CHECK

ADDITIONAL STABILITY

Carbonfiber is lightweight and robust. Comparing with "Steel" material, the performance is reported as following situation.

Weight

1 / 3

Strength

x 10

Elasticity

x 7

And RCP-200T / 260T has "Ring Lock" which minimizes axial eccentricity.

► SPECIFICATIONS

Model	RCP-200T	RCP-260T
Full extended	2,000mm	2,600mm
Full closed	1,150mm	1,480mm
Screw	5/8 inch male	5/8 inch male
Weight	1.00kg	1.30kg

► STANDARD ACCESSORIES

- Carrying Case



Product Link

PRODUCT NAME	MODEL	PKG QTY	MOQ	CODE NO.	C/O
Carbonfiber Pole / 2,000mm	RCP-200T	10	10	219383	CN
Carbonfiber Pole / 2,600mm	RCP-260T	10	10	219378	CN

Bipod

BIP-180

THUMB RELEASE

It is easy to get the level by thumb release.



* The pole is an optional product.

Rustproof stainless shoe

✓ CHECK

QUICK THUMB RELEASE

It's easy to set up as leveling with one push on quick thumb release.



► SPECIFICATIONS

Full extended	: 1,800mm
Full closed	: 1,080mm
Weight	: 2.5kg
Pole size	: 21 ~ 38mm φ
Material	: Aluminium

► STANDARD ACCESSORIES

- Carrying case



Product Link

PRODUCT NAME	MODEL	PKG QTY	MOQ	CODE NO.	C/O
Bipod	BIP-180	4	4	217426	CN
Case for BIP-180	BIP-180-C	10	10	221995	CN
Replacement Shoe for BIP-180	BIP-1	-	1	219118	CN

Case for RTK Pole & Bipod

RB-C

CARRY WHOLE UNIT

Improving working efficiency by carrying whole unit.



✓ CHECK

CARRY WHOLE UNIT

RB-C can store the bipod & RTK pole. It's easy to carry around and set up at field.

► SPECIFICATIONS

Length : 1,890mm

PRODUCT NAME	MODEL	PKG QTY	MOQ	CODE NO.	C/O
RTK Pole & Bipod Case	RB-C	10	10	219405	CN

GNSS Receiver Pole**SKY LIFTER 3****THE LONGEST POLE**

Extendable up to 15m with additional poles.



SKY-LF



Parts (5m)

► SPECIFICATIONS

Antenna height : 2 ~ 15m (1m joint type)
 *up to 15m if using optional poles
 Body weight : 10kg
 Pole weight : 870g / 1pc
 Pole material : Aluminium

► ATTACHED ITEMS (SKY-LF)

- Main body
- Centripetal disc
- Elevating handle
- Antenna adapter
- Bag for main body
- 5m pole (1m x 5)
- Adapter for measuring point
- Antenna pole set
- Anchor wire x 4
- Branch line adapter
- Branch line wire set x 4
- Turnbuckle x 4
- Winder for branch line

► REMARKS

- All include package (SKY-LF)
- Additional Poles (1m x 5pcs) (SKY-PL)

✓ CHECK**THE LONGEST POLE**

Extendable up to 15m with additional poles.
 Easy to extend by handling systems and no need to set GNSS from high-position.
 Sustain wires comes with and bring much stability.

PRODUCT NAME	MODEL	PKG QTY	MOQ	CODE NO.	C/O
Sky Lifter 3	SKY-LF	1	1	102535	JP
Additional Poles	SKY-PL	1	1	102536	JP

GNSS Receiver Pole**MG SATELLITE POLE****MAKING EXTRA HEIGHT**

Making extra height by easy setting with jointable pole.



* Full extended : 2m

► CONTENTS (GPS-P02)Attachment
5/8 inch
(MY-AT)Tip adapter
(MY-ADP)Aluminium pole
40mm φ
(MY-PL)**✓ CHECK****MAKING EXTRA HEIGHT**

Only need tribrach and tripod to set up GNSS antenna at high position, up to 2m. Yellow color body is easy to find from far away.
 Recommended height is up to 2m by pole joint.

PRODUCT NAME	MODEL	PKG QTY	MOQ	CODE NO.	C/O
MG Satellite Pole	GPS-P02	1	1	102473	JP
Tip Adapter	MY-ADP	1	1	102527	JP
1m Pole x 2pcs with Carrying Case	MY-PL	1	1	102528	JP
Attachment	MY-AT	1	1	102529	JP
1m Pole x 1pc	MY-PL1	1	1	218591	JP
Carrying Case for Pole	MY-PLC	1	1	218592	JP

Aluminium Ranging Pole

MYPL series

GOOD MARKING POLE

MYPL series is good marking pole at working site.

CHECK

GOOD MARKING POLE

Standard marking pole.
Extendable by easy - twist lock.
It is good for marking at working field to make alert.

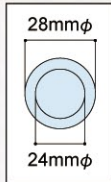

Pole Diameter



Color interval at 20cm each for checking height

SPECIFICATIONS

Model	MYPL-22	MYPL-32
Full extended	2,065mm	3,059mm
Full closed	1,212mm	1,806mm
Weight	520g	740g
Material	Aluminium	Aluminium
Section	2m / 2sec.	3m / 2sec.
Color interval	20cm interval	20cm interval



Product Link

MYPL-22 MYPL-32

PRODUCT NAME	MODEL	PKG QTY	MOQ	CODE NO.	C/O
Ranging Pole / 2,000mm	MYPL-22	10	30	031001	CN
Ranging Pole / 3,000mm	MYPL-32	10	30	031002	CN

Pole Stand

PS series

HOLDING POLES

Simple pole holder with 2 types of length.

CHECK

HOLDING POLES

Poles from 25mm to 35mmφ can be held.
2 types of length are available and able to pick the best matching for your needs.



PS-L

PS-S



Fix strongly



With stand cap

SPECIFICATIONS

Model	PS-L	PS-S
Length	910mm	510mm
Weight	1.72kg	1.00kg
Material	Steel	Steel
Outer diameter	80mmφ	80mmφ

PRODUCT NAME	MODEL	PKG QTY	MOQ	CODE NO.	C/O
Pole Stand - L	PS-L	6	6	218834	JP
Pole Stand - S	PS-S	6	6	218835	JP

Ranging Pole (Wood / Aluminium)

Ranging Pole

STANDARD WOODEN POLE / TOUGH MARKING POLE

MTPL series is aluminium-made, tough marking pole with straight and joint type.

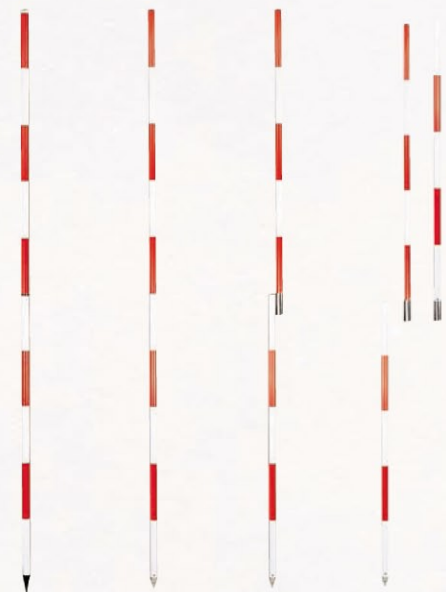

WDPL-2 MTPL-2 MTPL-22 MTPL-33

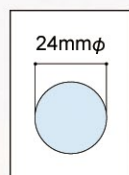

Pole Diameter (MTPL series)

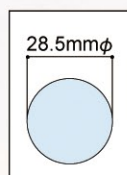

Pole Diameter (WDPL-2)

CHECK

TUBULAR JOINT (MTPL-22 / MTPL-33)

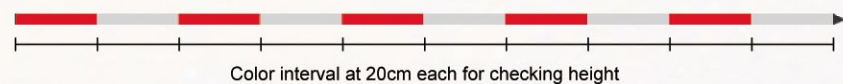

Color interval at 20cm each for checking height

SPECIFICATIONS

Model	WDPL-2	MTPL-2	MTPL-22	MTPL-33
Full extended	2,000mm	2,000mm	2,000mm	3,000mm
Weight	820g	330g	480g	720g
Material	Wood	Aluminium	Aluminium	Aluminium
Section	2m / 1sec.	2m / 1sec.	2m / 2sec.	3m / 3sec.
Color interval	20cm interval	20cm interval	20cm interval	20cm interval

STANDARD ACCESSORIES

- Case (MTPL-22/33)

PRODUCT NAME	MODEL	PKG QTY	MOQ	CODE NO.	C/O
Ranging Pole / Wood / 2m / 1sec.	WDPL-2	20	20	217182	JP
Ranging Pole / Aluminium / 2m / 1sec.	MTPL-2	30	30	217183	CN
Ranging Pole / Aluminium / 2m / 2sec.	MTPL-22	15	15	031014	CN
Ranging Pole / Aluminium / 3m / 3sec.	MTPL-33	10	10	031012	CN



Product Link

Auto-counted Fiberglass Measuring Pole

SK series

NON-CONDUCTIVE MEASURING POLE

This is made of fiberglass for height measuring work.



Height counter



Head metal fittings

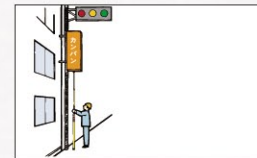

For outdoor using

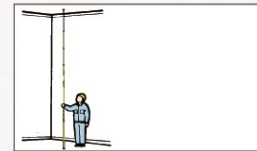

For indoor using

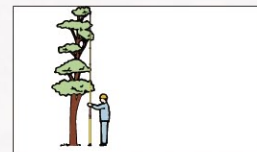

For forest survey

✓ CHECK

NON-CONDUCTIVE MEASURING POLE

Non-conductive measuring pole fits a special situation such as under electric line. It is light weight by thin fiberglass material but it is durable body. A digital type reading of tape measure at the bottom pole can answer the measuring value in one glance. You can measure a height especially for overhead cable without worry for electric shock. Variety choices of pole length from 4m to 12m models meet variety applications and sites.

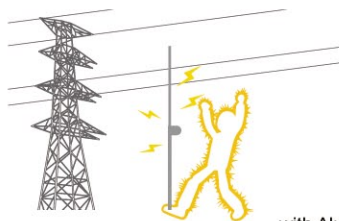

with Aluminium pole

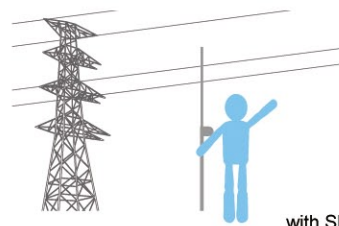

with SK series pole

► SPECIFICATIONS

Model	NO.202-4(SK-48)	NO.202-6(SK-68)	NO.212-12(SK-1210)	NO.212-6	NO.212-8
Full extended	4m	6m	12m	6m	8m
Full closed	690mm	940mm	1,420mm	970mm	1,220mm
Weight	0.83kg	1.10kg	2.76kg	1.45kg	1.74kg
Graduation	Metric	Metric	Metric	Metric	Metric
Section	4m / 8sec.	6m / 8sec.	12m / 10sec.	6m / 8sec.	8m / 8sec.

► REMARKS

- Mini Type (NO. 212-6 / NO. 212-8)

PRODUCT NAME	MODEL	PKG QTY	MOQ	CODE NO.	C/O
Measuring Pole (4,000mm)	NO.202-4(SK-48)	1	1	102019	JP
Measuring Pole (6,000mm)	NO.202-6(SK-68)	1	1	102020	JP
Measuring Pole (12,000mm)	NO.212-12(SK-1210)	1	1	210102	JP

PRODUCT NAME	MODEL	PKG QTY	MOQ	CODE NO.	C/O
Measuring Pole (6,000mm) Mini Type	NO.212-6	1	1	218011	JP
Measuring Pole (8,000mm) Mini Type	NO.212-8	1	1	218012	JP

TRIPOD 1
PRISM 2
POLE 3
STAFF 4
GNSS ACCESSORY 5
SURVEYING / LASER INSTRUMENT 6
SURVEYING ACCESSORY 7
MEASURING TOOL 8
TESTING INSTRUMENT 9
SECURITY GOODS 10

Fiberglass Measuring Pole

SK Pole

NON-CONDUCTIVE MEASURING POLE

Good for measuring in the city street.



	MT	FT	AT	QT	FS	K	AK
Graduation	Metric	Metric	Metric	Metric	Metric	Red & White	Red & White
Tip	T shape	T shape	T shape	T shape	S shape	Plastic cap	Plastic cap
Joint	Rubber	Rubber	Taper	Quick	Rubber	Rubber	Taper

CHECK

Height Sign



Metric (1cm)



Red & White (20cm)

CHECK

Joint style



Rubber



Taper

Rubber : It keeps out water.
Taper : Storage size gets short.

CHECK

Tip Parts



T shape Standard



S shape for Cable



Plastic Cap

SPECIFICATIONS

Model	MT-6	MT-8	MT-10	MT-12	FT-6	FT-8	FT-10	FT-12	AT-6	AT-8	AT-10	AT-12	AT-15	QT-12
Full extended	6m	8m	10m	12m	6m	8m	10m	12m	6m	8m	10m	12m	15m	12m
Full closed	840mm	1,000mm	1,200mm	1,200mm	1,260mm	1,410mm	1,510mm	1,600mm	1,100mm	1,100mm	1,100mm	1,100mm	1,100mm	1,440mm
Weight	1.4kg	1.7kg	2.1kg	3kg	0.86kg	1.43kg	2.00kg	2.70kg	0.50kg	0.75kg	1.05kg	1.50kg	2.30kg	2.75kg
Section	12sec.	12sec.	12sec.	15sec.	6sec.	8sec.	10sec.	12sec.	6sec.	8sec.	10sec.	12sec.	15sec.	12sec.

Model	FS-6	FS-8	FS-10	FS-12	K-8	K-10	K-12	AK-3	AK-5	AK-8	AK-10	AK-12	AK-15
Full extended	6m	8m	10m	12m	8m	10m	12m	3m	5m	8m	10m	12m	15m
Full closed	1,270mm	1,420mm	1,520mm	1,610mm	1,360mm	1,460mm	1,560mm	1,143mm	1,143mm	1,100mm	1,100mm	1,100mm	1,100mm
Weight	0.85kg	1.40kg	2.10kg	2.80kg	1.46kg	2.08kg	2.84kg	0.45kg	0.66kg	0.75kg	1.05kg	1.5kg	2.3kg
Section	6sec.	8sec.	10sec.	10sec.	8sec.	10sec.	12sec.	3sec.	5sec.	8sec.	10sec.	12sec.	15sec.

PRODUCT NAME	MODEL	PKG QTY	MOQ	CODE NO.	C/O
Measuring Pole 6m	MT-6	1	1	-	JP
Measuring Pole 8m	MT-8	1	1	-	JP
Measuring Pole 10m	MT-10	1	1	-	JP
Measuring Pole 12m	MT-12	1	1	-	JP

PRODUCT NAME	MODEL	PKG QTY	MOQ	CODE NO.	C/O
Measuring Pole 6m	FT-6	1	1	102041	JP
Measuring Pole 8m	FT-8	1	1	102042	JP
Measuring Pole 10m	FT-10	1	1	102043	JP
Measuring Pole 12m	FT-12	1	1	102044	JP

PRODUCT NAME	MODEL	PKG QTY	MOQ	CODE NO.	C/O
Measuring Pole 6m	AT-6	1	1	102056	JP
Measuring Pole 8m	AT-8	1	1	102057	JP
Measuring Pole 10m	AT-10	1	1	102058	JP
Measuring Pole 12m	AT-12	1	1	102059	JP
Measuring Pole 15m	AT-15	1	1	102060	JP

PRODUCT NAME	MODEL	PKG QTY	MOQ	CODE NO.	C/O
Measuring Pole 12m	QT-12	1	1	215330	JP

PRODUCT NAME	MODEL	PKG QTY	MOQ	CODE NO.	C/O
Measuring Pole 6m	FS-6	1	1	102045	JP
Measuring Pole 8m	FS-8	1	1	102046	JP
Measuring Pole 10m	FS-10	1	1	102047	JP
Measuring Pole 12m	FS-12	1	1	102048	JP

PRODUCT NAME	MODEL	PKG QTY	MOQ	CODE NO.	C/O
Measuring Pole 8m	K-8	1	1	102031	JP
Measuring Pole 10m	K-10	1	1	102032	JP
Measuring Pole 12m	K-12	1	1	102033	JP

PRODUCT NAME	MODEL	PKG QTY	MOQ	CODE NO.	C/O
Measuring Pole 3m	AK-3	1	1	-	JP
Measuring Pole 5m	AK-5	1	1	-	JP
Measuring Pole 8m	AK-8	1	1	221506	JP
Measuring Pole 10m	AK-10	1	1	221507	JP
Measuring Pole 12m	AK-12	1	1	221508	JP
Measuring Pole 15m	AK-15	1	1	210103	JP



STAFF

- Aluminium Staff P061
- Prism Staff P065
- Fiberglass Precision Staff P066
- Fiberglass Staff P067
- Drain Staff / Scale Staff P068
- Bipod for Staff / Staff Accessory P069
- Circular Level / Display Stand / Photo Record Accessory P070

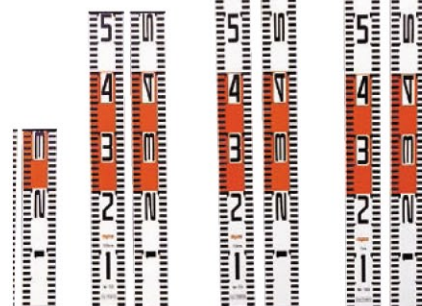
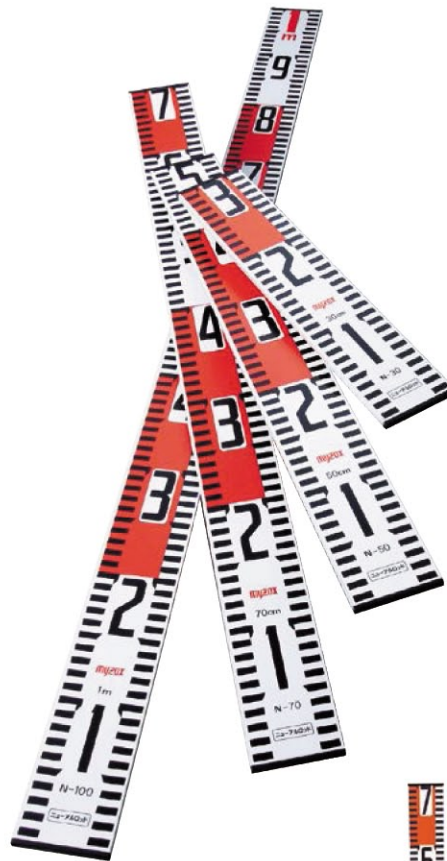

TRIPOD	1
PRISM	2
POLE	3
STAFF	4
GNSS ACCESSORY	5
SURVEYING / LASER INSTRUMENT	6
SURVEYING ACCESSORY	7
MEASURING TOOL	8
TESTING INSTRUMENT	9
SECURITY GOODS	10

Myzox's Aluminium Staff

Our logo



Myzox is the first manufacturer who developed and launched the Aluminium Leveling Staff in Japan.

We have developed 13 kinds of leveling staff based on the request of professional users.

Those leveling staves are passed our strict inspections and have our logo on the surface.

Myzox logo is the tribute to the quality of the quality approved by professional users.

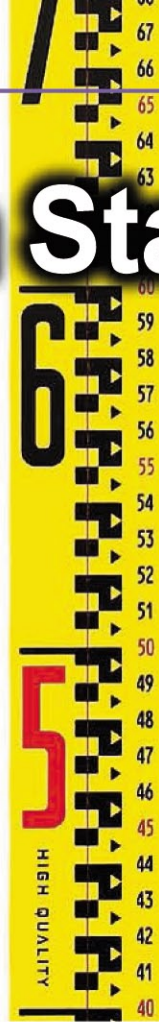

Introduction

Graduation

Front graduation

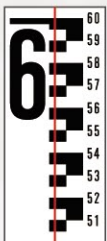

Metric W
5mm / 10mm
White

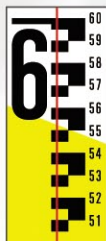

Metric YW
5mm / 10mm
Yellow / White



E face



EB face



TRI-E



TRI-M

Back graduation

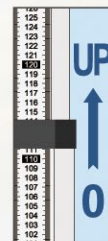

0 UP
0mm to up
from the bottom

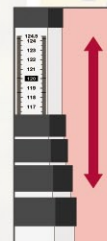

Inside
Measuring
inside dimension



Photo
For photo record

Button Myzox's replacement buttons

Square button



MG-02A



MG-04

for MST, ALG, ALX, SUN, STN, RFC, SWG series

Staves with MG-02A and Button Protection Label MG-02PS

- Aluminium Staff Quality type (MST series)
- Prism Staff (RFC series)
- Drain Staff (SWG-54)
- ALG-25Y

Staves with MG-04

- Aluminium Staff Standard type (ALG series) *except for ALG-25Y
- Aluminium Staff Slim type (SUN series)
- Aluminium Staff Less Section type (STN-54)

Button protection label

MG-02PS



Able to use only with MG-02A



Round button



MG-01
for ALM, SUM, ALS series



MG-03
for MTR series



Aluminium Staff Quality type

MST series

ADVANCED IDEA

MST series has an advanced idea on the graduation, Tri-Mark.

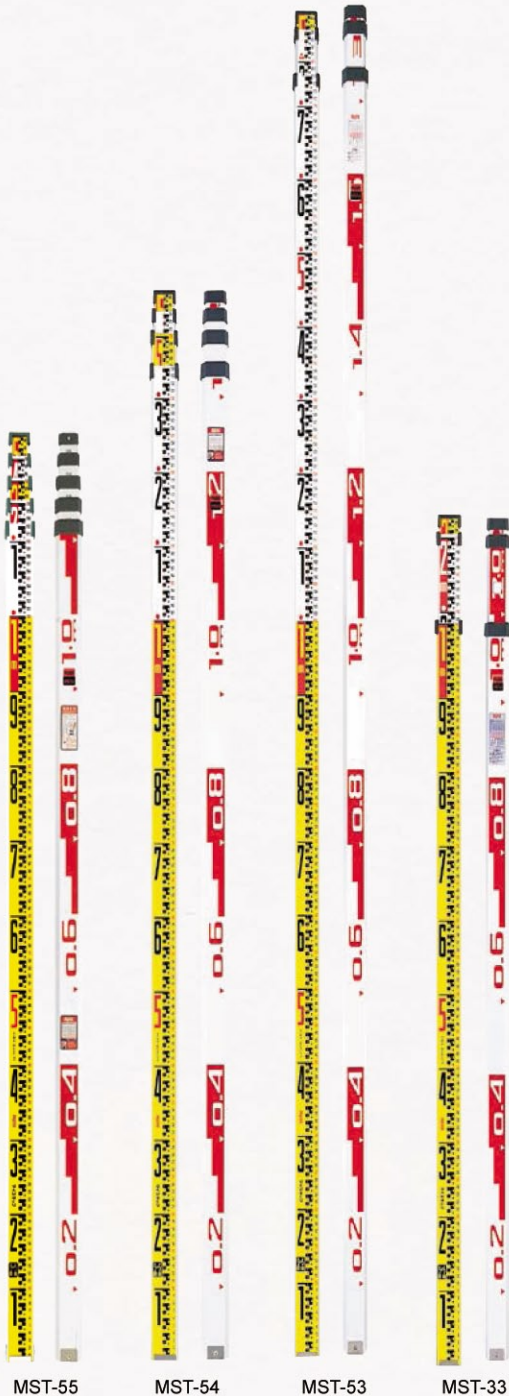

MST-55 MST-54 MST-53 MST-33

✓ CHECK

ADVANCED IDEA TO BRING ACCURACY

High-quality staff with Tri-mark graduation makes you get more accurate measuring data.

TRI-MARK

*The staff with TRI-E is ALX series. (Ref. Page 063)

How to Read

✓ CHECK

S.T.C. coating

S.T.C (Super Top Coating)
Clear coating
Graduation
Aluminium

✓ CHECK

Stainless bottom

SA-60
Circular level 60° / 2mm (Option)
Ref. Page 070

Dimensions 5m / 5sec. (MST-55)

MG-02A
Staff button
Ref. Page 069

Dimensions 5m / 4sec. (MST-54)

MG-02PS
Button protection label
Ref. Page 069

Dimensions 5m / 3sec. (MST-53)

► SPECIFICATIONS

Model	MST-55	MST-54	MST-53	MST-33
Graduation (front)	Metric YW	Metric YW	Metric YW	Metric YW
Graduation (back)	Photo / Inside	Photo	Photo	Photo
Section	5m / 5sec.	5m / 4sec.	5m / 3sec.	3m / 3sec.
Full closed	1,245mm	1,445mm	1,836mm	1,146mm
Weight	1.70kg	1.73kg	1.56kg	0.94kg

► STANDARD ACCESSORIES

- Button protection label MG-02PS

PRODUCT NAME	MODEL	PKG QTY	MOQ	CODE NO.	C/O
Aluminium Staff 5m/5sec.	MST-55	8	8	217630	TW
Aluminium Staff 5m/4sec.	MST-54	8	8	217633	TW
Aluminium Staff 5m/3sec.	MST-53	8	8	217631	TW
Aluminium Staff 3m/3sec.	MST-33	8	8	217632	TW



TRIPOD 1
PRISM 2
POLE 3
STAFF 4
GNSS ACCESSORY 5
SURVEYING / LASER INSTRUMENT 6
SURVEYING ACCESSORY 7
MEASURING TOOL 8
TESTING INSTRUMENT 9
SECURITY GOODS 10

NEW Aluminium Staff Standard type
ALG series

STANDARD

ALG series is world standard type of staff.

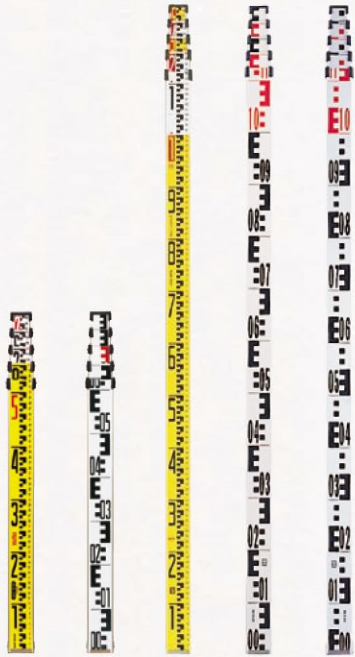

ALG-25Y ALG-25E ALG-55Y ALG-55E ALG-55EB



SA-60 Circular level 60/2mm (Option)
Ref. Page 070



MG-02A Staff button (ALG-25Y)
Ref. Page 069



MG-04 Staff button
Ref. Page 069

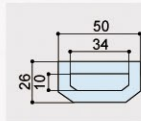

Dimensions

CHECK

STANDARD TYPE

World standard staff.
Having many choices such as colors, graduation and lengths and so on.
You can find the best matching one from the line-up.
Myzox is a top share company in Japanese market with ALG series.
Simple product, but there is a reason why Myzox is a top share.

SPECIFICATIONS

Model	ALG-550	ALG-55Y	ALG-55E	ALG-55E2	ALG-55EB	ALG-44
Graduation						
(front)	Metric W	Metric YW	E	E	EB	Metric W
(back)	0 UP	Photo / Inside	Inside	0 UP	Inside	-
Section	5m / 5sec.	5m / 5sec.	5m / 5sec.	5m / 5sec.	5m / 5sec.	4m / 4sec.
Full closed	1,245mm	1,245mm	1,245mm	1,245mm	1,245mm	1,216mm
Weight	1.70kg	1.70kg	1.70kg	1.70kg	1.70kg	1.44kg

Model	ALG-440	ALG-44E	ALG-44EB	ALG-25Y	ALG-25E2
Graduation					
(front)	Metric W	E	EB	Metric YW	E
(back)	0 UP	-	-	Inside	0 UP
Section	4m / 4sec.	4m / 4sec.	4m / 4sec.	2m / 5sec.	2m / 5sec.
Full closed	1,216mm	1,216mm	1,216mm	645mm	645mm
Weight	1.44kg	1.44kg	1.44kg	0.9kg	0.9kg

STANDARD ACCESSORIES

- Button protection label MG-02PS (ALG-25Y only)



Product Link

PRODUCT NAME	MODEL	PKG QTY	MOQ	CODE NO.	C/O
Aluminium Staff 5m/5sec. Metric W	ALG-550	10	10	240051	TW
Aluminium Staff 5m/5sec. Metric YW	ALG-55Y	10	10	011005	TW
Aluminium Staff 5m/5sec. E face	ALG-55E	10	10	091551	TW
Aluminium Staff 5m/5sec. E face	ALG-55E2	10	10	240028	TW
Aluminium Staff 5m/5sec. EB face	ALG-55EB	10	10	091545	TW
Aluminium Staff 4m/4sec. Metric W	ALG-44	10	10	091553	TW
Aluminium Staff 4m/4sec. Metric W	ALG-440	10	10	240052	TW
Aluminium Staff 4m/4sec. E face	ALG-44E	10	10	091554	TW
Aluminium Staff 4m/4sec. EB face	ALG-44EB	10	10	091546	TW
Aluminium Staff 2m/5sec. Metric WY	ALG-25Y	10	10	221495	TW
Aluminium Staff 2m/5sec. E face	ALG-25E2	10	10	222056	TW

Aluminium Staff Heavy-duty type
ALM series

HEAVY-DUTY

ALM series is heavy-duty and robust and wide type of staff.



ALM-55 ALM-55E ALM-44I



SB-60 Circular level 60/2mm
Ref. Page 070



MG-01 Staff button
Ref. Page 069

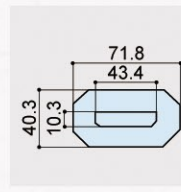

Dimensions

CHECK

HEAVY-DUTY TYPE

Robust type staff with wide size surface.
It is easy to see the graduation from far and get more accurate measuring data.
Circular level and carrying case comes with as standard accessories.

Standard type

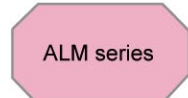

*Reduction by same ratio

SPECIFICATIONS

Model	ALM-55	ALM-55E	ALM-44
Graduation (front)	Metric YW	E	Metric YW
Graduation (back)	-	0 UP	-
Section	5m / 5sec.	5m / 5sec.	4m / 4sec.
Full closed	1,305mm	1,305mm	1,250mm
Weight	3.00kg	3.00kg	2.50kg

Model	ALM-44E	ALM-44I
Graduation (front)	E	Indian
Graduation (back)	-	-
Section	4m / 4sec.	4m / 4sec.
Full closed	1,250mm	1,250mm
Weight	2.50kg	2.50kg

STANDARD ACCESSORIES

- Carrying case
- Circular level SB-60 (60/2mm)



Product Link

PRODUCT NAME	MODEL	PKG QTY	MOQ	CODE NO.	C/O
Aluminium Staff 5m/5sec. Metric YW	ALM-55	5	5	011051	TW
Aluminium Staff 5m/5sec. E face	ALM-55E	5	5	091568	TW
Aluminium Staff 4m/4sec. Metric YW	ALM-44	5	5	091570	TW
Aluminium Staff 4m/4sec. E face	ALM-44E	5	5	091571	TW
Aluminium Staff 4m/4sec. Indian grad.	ALM-44I	5	5	217941	TW

NEW Aluminium Staff Economical type
ALX series / AGX series

GOOD BALANCED

Good balanced economical model.



ALX-55E

AGX-55E



SA-60
Circular level 60"/2mm
(Option)
Ref. Page 070



MG-02A
Staff button
(Option)
Ref. Page 069

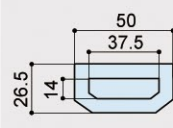

Dimensions
4m / 4sec.

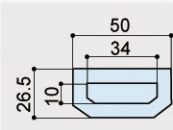

Dimensions
5m / 5sec.

Aluminium Staff Wide type
SUM series

WIDE, NOT HEAVY

Wide type staff, but not to heavy to carry around.

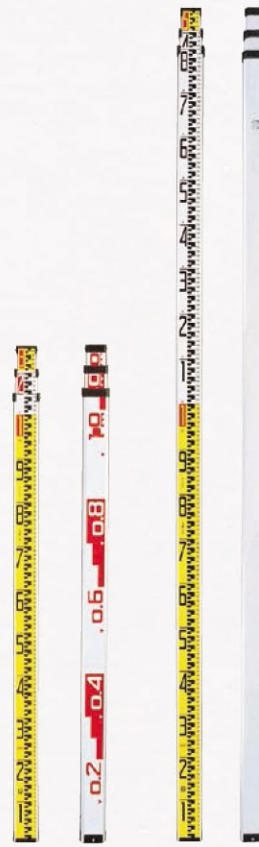

SUM-33

SUM-53



SB-60
Circular level 60"/2mm
(Option)
Ref. Page 070



MG-01
Staff button
Ref. Page 069

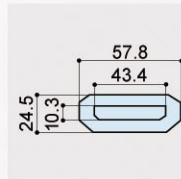

Dimensions

CHECK

2 TYPES OF GRADUATION



ALX series
TRI-E type
Ref. Page 061



AGX series
Regular type

CHECK

WIDE, NOT HEAVY

Wide face is easy to see measuring result even long distance. Furthermore, it is not heavy to carry around. Less section will give you accurate measuring results.

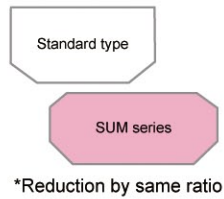

*Reduction by same ratio

SPECIFICATIONS

Model	SUM-53	SUM-53E	SUM-43
Graduation (front)	Metric YW	E	Metric YW
Graduation (back)	-	-	-
Section	5m / 3sec.	5m / 3sec.	4m / 3sec.
Full closed	1,900mm	1,900mm	1,519mm
Weight	2.00kg	2.00kg	1.50kg

Model	SUM-43E	SUM-33	SUM-33E
Graduation (front)	E	Metric YW	E
Graduation (back)	-	Photo	-
Section	4m / 3sec.	3m / 3sec.	3m / 3sec.
Full closed	1,519mm	1,150mm	1,150mm
Weight	1.50kg	1.20kg	1.20kg



Product Link

SPECIFICATIONS

Model	ALX-55E	ALX-55Y	ALX-44E
Graduation (front)	TRI-E	Metric YW	TRI-E
Graduation (back)	Inside	Photo / Inside	Inside
Section	5m / 5sec.	5m / 5sec.	4m / 4sec.
Full closed	1,235mm	1,235mm	1,195mm
Weight	1.50kg	1.50kg	1.40kg

Model	AGX-55E	AGX-33E
Graduation (front)	E	E
Graduation (back)	0 UP	0 UP
Section	5m / 5sec.	3m / 3sec.
Full closed	1,235mm	1,170mm
Weight	1.50kg	1.00kg



Product Link

PRODUCT NAME	MODEL	Pkg QTY	MOQ	CODE NO.	C/O
Aluminium Staff 5m/5sec. TRI-E	ALX-55E	10	10	217926	CN
Aluminium Staff 5m/5sec. Metric YW	ALX-55Y	10	10	217940	CN
Aluminium Staff 4m/4sec. TRI-E	ALX-44E	10	10	217927	CN
Aluminium Staff 5m/5sec. E face	AGX-55E	10	10	221361	CN
Aluminium Staff 3m/3sec. E face	AGX-33E	10	10	221362	CN

PRODUCT NAME	MODEL	Pkg QTY	MOQ	CODE NO.	C/O
Aluminium Staff 5m/3sec. Metric YW	SUM-53	10	10	011052	TW
Aluminium Staff 5m/3sec. E face	SUM-53E	10	10	091580	TW
Aluminium Staff 4m/3sec. Metric YW	SUM-43	10	10	915874	TW
Aluminium Staff 4m/3sec. E face	SUM-43E	10	10	091588	TW
Aluminium Staff 3m/3sec. Metric YW	SUM-33	10	10	011053	TW
Aluminium Staff 3m/3sec. E face	SUM-33E	10	10	091597	TW

TRIPOD 1
PRISM 2
POLE 3
STAFF 4
GNSS ACCESSORY 5
SURVEYING / LASER INSTRUMENT 6
SURVEYING ACCESSORY 7
MEASURING TOOL 8
TESTING INSTRUMENT 9
SECURITY GOODS 10

Aluminium Staff Slim type

SUN series

THE LIGHTEST TYPE

One of the lightest type in Myzox's line up.



SUN-33

SUN-53



SA-60
Circular level 60/2mm
(Option)
Ref. Page 070



MG-04
Staff button
Ref. Page 069

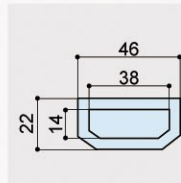

Dimensions

Aluminium Staff Less Section type

STN-54

MIDDLE SIZE

Middle size ; Balanced staff.



STN-54



SA-60
Circular level 60/2mm
(Option)
Ref. Page 070



MG-04
Staff button
Ref. Page 069

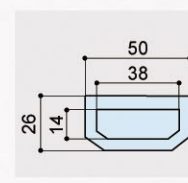

Dimensions

✓ CHECK

THE LIGHTEST TYPE

One of the lightest type in Myzox's staves line-up.
The weight of 3m x 3 sec. type is less than 1kg.
Also, longer type staff, 5m x 3sec. is suitable for a site where has height differences.

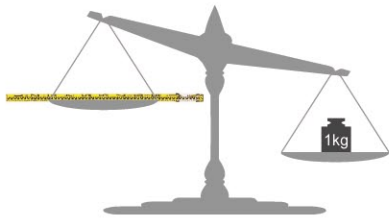

► SPECIFICATIONS

Model	SUN-53	SUN-33
Graduation (front)	Metric YW	Metric YW
Graduation (back)	Photo	Photo
Section	5m x 3sec.	3m / 3sec.
Full closed	1,836mm	1,146mm
Weight	1.56kg	0.94kg



Product Link

PRODUCT NAME	MODEL	PKG QTY	MOQ	CODE NO.	C/O
Aluminium Staff 5m/3sec. Metric YW	SUN-53	8	8	011008	TW
Aluminium Staff 3m/3sec. Metric YW	SUN-33	8	8	011009	TW

✓ CHECK

MIDDLE SIZE

1st section is around 1.5m, so you can often survey without extending
2nd section.
It will lead to efficient works.

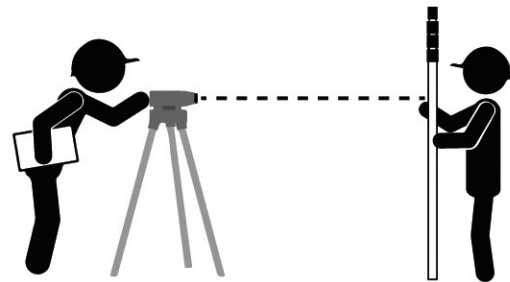

► SPECIFICATIONS

Graduation (front)	: Metric YW
Graduation (back)	: Photo
Section	: 5m / 4sec.
Full closed	: 1,445mm
Weight	: 1.73kg

PRODUCT NAME	MODEL	PKG QTY	MOQ	CODE NO.	C/O
Aluminium Staff 5m/4sec. Metric YW	STN-54	10	10	011011	TW

Prism Staff

RFC series

PRISM STAFF

The face of prism staff can be used as prism.



RFC-33 RFC-54 RFC-53

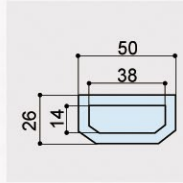

Dimensions
5m / 4sec.

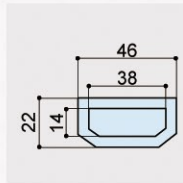

Dimensions
5m / 3sec.
3m / 3sec.



SA-60
Circular level 60' / 2mm
(Option)
Ref. Page 070



MG-02A
Staff button
Ref. Page 069



MG-02PS
Button protection label
Ref. Page 069

✓ CHECK

PRISM STAFF

Reflecting face of the staff can be used as prism.

No need to bring prism to field by using this "2 in 1" product.

Yellow and silver background for every single meter and easy to find out its length from far side.

Button protection sticker is also attached.

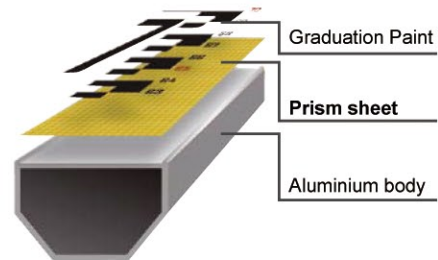

✓ CHECK

GOOD FOR FOREST SURVEYING

When sectional surveying in forest, users like to reduce extra tools, it invites the exhaustion, and results in inefficient works.

If using RFC staff, you don't need taking the prism.

Also, when using the prism, you can not often target the prism by trees or leaves in the way.

In case of RFC staff, which has wide surface, you can aim the target easily.



► SPECIFICATIONS

Model	RFC-53	RFC-54	RFC-33
Graduation (front)	Metric YW	Metric YW	Metric YW
Graduation (back)	-	-	-
Section	5m / 3sec.	5m / 4sec.	3m / 3sec.
Full closed	1,836mm	1,445mm	1,146mm
Weight	1.56kg	1.73kg	0.94kg

► STANDARD ACCESSORIES

- Carrying case
- Button protection label MG-02PS

PRODUCT NAME	MODEL	PKG QTY	MOQ	CODE NO.	C/O
Prism Staff 5m/3sec. Metric YW	RFC-53	1	5	211101	TW
Prism Staff 5m/4sec. Metric YW	RFC-54	1	5	211102	TW
Prism Staff 3m/3sec. Metric YW	RFC-33	1	5	220871	TW

Aluminium Staff Long type

ALS-74

LONGEST BODY

ALS-74 has the longest body in Myzox's line up.



ALS-74

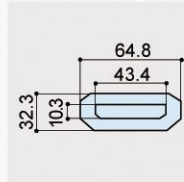

Dimensions



SB-60
Circular level 60' / 2mm
(Option)
Ref. Page 070



MG-01
Staff button
Ref. Page 069

Fiberglass Precision Staff

GPR-351

CERTIFIED PRECISION STAFF

Certified as 2nd class high precision fiberglass staff.

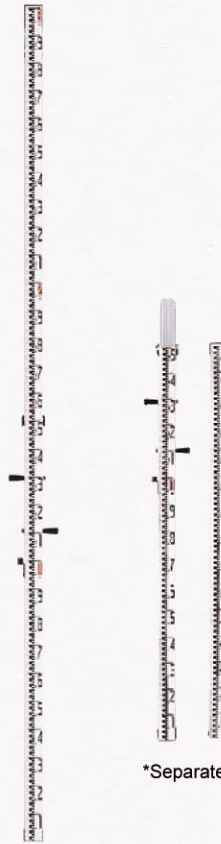

GPR-351

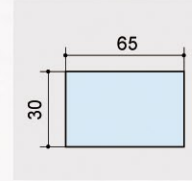

Dimensions

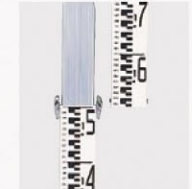

Stiff and reliable joint



5mm/10mm graduation



Built-in circular level

*Separated

✓ CHECK

LONGEST BODY

The longest staff : each section is very long and having much straightness by the long sections.
Also, it's easy to measure water level by the long body.

FULL EXTENDED

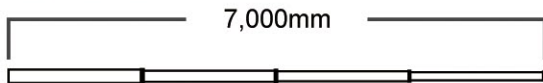

FULL CLOSED

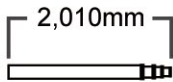

✓ CHECK

CERTIFIED PRECISION STAFF

Certified as 2nd class high precision fiberglass staff by Geospatial Information Authority of Japan.
Easy to carry by breaking down into two sections.

Qualifying Standard of 2nd class

Graduation	Accuracy	Level Sensitivity
Metric (5mm / 10mm)	200µm/m	15' ~ 25'

* It's possible to issue certification of examination by Japan Association of Surveyors.

► SPECIFICATIONS

Model	ALS-74	ALS-74E
Graduation (front)	Metric YW	E
Graduation (back)	Photo	0 UP
Section	7m / 4sec.	7m / 4sec.
Full closed	2,010mm	2,010mm
Weight	3.20kg	3.20kg



Product Link

PRODUCT NAME	MODEL	PKG QTY	MOQ	CODE NO.	C/O
Aluminium Staff 7m/4sec. Metric YW	ALS-74	2	4	011201	TW
Aluminium Staff 7m/4sec. E face	ALS-74E	2	4	240020	TW

► SPECIFICATIONS

Graduation (front)	: Metric (5mm / 10mm)
Graduation (back)	: -
Type	: 3m / 2sec.
Full closed	: 1,500mm
Weight	: 3.75kg
Accuracy	: 200 µ m/m

► STANDARD ACCESSORIES

- Carrying case
- Built-in circular level

PRODUCT NAME	MODEL	PKG QTY	MOQ	CODE NO.	C/O
Fiberglass Precision Staff 3m/2sec.	GPR-351	1	1	011058	JP

Fiberglass Staff Oval Shape

GFS series

NON-CONDUCTIVE

GFS series is non-conductive staff, because of fiberglass.



GFS-1010

GFS-55



* Tip of the top section includes a 5/8x11 female threaded hole suitable for attaching a mini-prism.

✓ CHECK

NON-CONDUCTIVE

Non-conductive fiberglass staff is suitable for workings under electric wire or railway wiring. The body is high tolerant of temperature change (-50 ~ 120 °C). Easy to hold by round shape body. Various types of length are available.



► SPECIFICATIONS

Model	GFS-33	GFS-55	GFS-55E	GFS-55EB
Graduation (front)	Metric YW	Metric YW	E	EB
Graduation (back)	0 UP	0 UP	0 UP	0 UP
Section	3m / 3sec.	5m / 5sec.	5m / 5sec.	5m / 5sec.
Full closed	1,200mm	1,300mm	1,300mm	1,300mm
Weight	0.76kg	1.32kg	1.32kg	1.32kg

Model	GFS-77	GFS-77E	GFS-77EB	GFS-1010
Graduation (front)	Metric YW	E	EB	Metric W
Graduation (back)	0 UP	0 UP	0 UP	-
Section	7m / 7sec.	7m / 7sec.	7m / 7sec.	10m / 10sec.
Full closed	1,410mm	1,410mm	1,410mm	1,700mm
Weight	1.98kg	1.98kg	1.98kg	3.55kg

► STANDARD ACCESSORIES

- Carrying case



Product Link

PRODUCT NAME	MODEL	PKG QTY	MOQ	CODE NO.	C/O
Fiberglass Staff 3m/3sec. Metric YW	GFS-33	5	5	220414	JP
Fiberglass Staff 5m/5sec. Metric YW	GFS-55	5	5	011101	JP
Fiberglass Staff 5m/5sec. E face	GFS-55E	5	5	-	JP
Fiberglass Staff 5m/5sec. EB face	GFS-55EB	5	5	091101	JP
Fiberglass Staff 7m/7sec. Metric YW	GFS-77	5	5	011102	JP
Fiberglass Staff 7m/7sec. E face	GFS-77E	5	5	-	JP
Fiberglass Staff 7m/7sec. EB face	GFS-77EB	5	5	091102	JP
Fiberglass Staff 10m/10sec. Metric W	GFS-1010	1	1	011103	JP

Fiberglass Staff Hexagonal Shape

GFX-series

ECONOMICAL FIBERGLASS STAFF

GFX is economical and non-conductive.



GFX-55EB

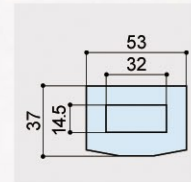

Dimensions

✓ CHECK

HEXAGONAL SHAPE

GFX has hexagonal shape. When mounting the clamp, hexagonal shape creates the friction on plane, and the clamp can hold the staff tightly.



► SPECIFICATIONS

Model	GFX-55E0	GFX-55E	GFX-55EB0	GFX-55EB
Graduation(front)	E	E	EB	EB
Graduation(back)	0 UP	Inside	0 UP	Inside
Section	5m / 5sec.	5m / 5sec.	5m / 5sec.	5m / 5sec.
Full closed	1,314mm	1,314mm	1314mm	1,314mm
Weight	2.8kg	2.8kg	2.8kg	2.8kg

► STANDARD ACCESSORIES

- Carrying case

PRODUCT NAME	MODEL	PKG QTY	MOQ	CODE NO.	C/O
Fiberglass Staff Hexagonal Shape E face	GFX-55E0	10	10	-	CN
Fiberglass Staff Hexagonal Shape E face	GFX-55E	10	10	-	CN
Fiberglass Staff Hexagonal Shape EB face	GFX-55EB0	10	10	-	CN
Fiberglass Staff Hexagonal Shape EB face	GFX-55EB	10	10	221294	CN

TRIPOD 1
PRISM 2
POLE 3
STAFF 4
GNSS ACCESSORY 5
SURVEIVING / LASER INSTRUMENT 6
SURVEIVING ACCESSORY 7
MEASURING TOOL 8
TESTING INSTRUMENT 9
SECURITY GOODS 10

Drain Staff

SWG-54

DRAIN STAFF

SWG-54 is specialized for drain use.



MG-02A
Staff button
Ref. Page 069



SWG-ADP



MG-02PS
Button protection label
Ref. Page 069



RL-60T
Circular level 60' / 2mm
Ref. Page 070

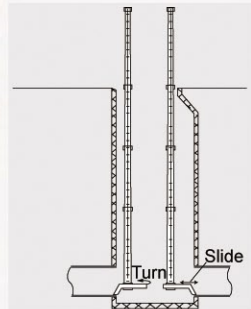

* 50cm arm is standard accessory.

SWG-54

✓ CHECK

DRAIN STAFF

Exactly designed to measure a depth of drain. The arm part can be adjusted to fit to diameter of a manhole between 150mm to 450mm.

It can be used as regular staff with adapter, SWG-ADP.

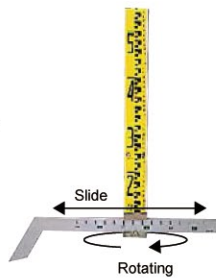

▶ SPECIFICATIONS

- Graduation (front) : Metric YW
- Graduation (back) : Photo
- Section : 5m / 4sec.
- Full closed : 1,360mm
- Weight : 2.70kg

▶ STANDARD ACCESSORIES

- 50cm arm (SWG-ARM50)
- Extension adapter for regular use (SWG-ADP)
- Circular level (RL-60T)
- Button protection label (MG-02PS)
- Case (SWG-54-C)

PRODUCT NAME	MODEL	PKG QTY	MOQ	CODE NO.	C/O
Drain Staff 5m/4sec. Metric YW	SWG-54	1	1	210101	TW
Point Arm 25cm	SWG-ARM25	1	1	217691	TW
Point Arm 50cm	SWG-ARM50	1	1	220857	TW
Extension Adapter	SWG-ADP	1	1	210407	TW
Case for SWG-54	SWG-54-C	-	10	221977	TW

Scale Staff

MTR series

SCALE STAFF

It's quite useful in various situations.



MTR-22

MTR-33



Front graduation
(mm)

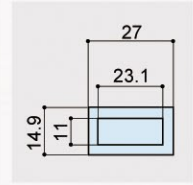

Dimensions
(MTR-22)



Back graduation
(10/33m)
*MTR-33 only

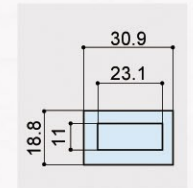

Dimensions
(MTR-33)

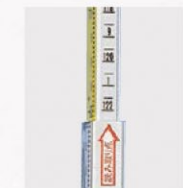

Side graduation
(5mm)



MG-03
Staff button
Ref. Page 069

✓ CHECK

SCALE STAFF

Scale staff is a simple structure, however it can be used for many situations.

Suitable for measuring inside dimensions such as door and window size.

Also, breaking down each section is very easy and you can use the separated section as a scale.

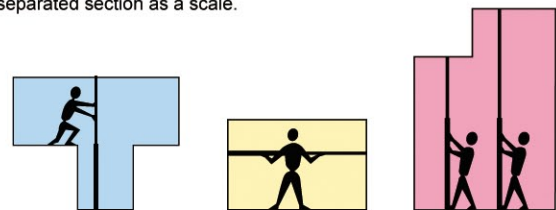

Depth

Width

Height

* How to measure inside dimensions

▶ SPECIFICATIONS

Model	MTR-22	MTR-33
Graduation	Metric	Metric
Section	2m / 2sec	3m / 3sec
Full closed	1,120mm	1,140mm
Weight	0.50kg	0.80kg



Product Link

PRODUCT NAME	MODEL	PKG QTY	MOQ	CODE NO.	C/O
Scale Staff 2m/2sec.	MTR-22	5	5	011036	TW
Scale Staff 3m/3sec.	MTR-33	5	5	011037	TW

Bipod for Staves

PFS

BIPOD FOR STAVES

Specialized bipod for all staves.



✓ CHECK

BIPOD FOR STAVES

Adjustable head part holds various type of staves certainly. The height can be adjustable by thumb release button quickly.



► SPECIFICATIONS

Full extended : 1,850mm
 Full closed : 1,100mm
 Weight : 2.40kg
 Fixturable width : 45 ~ 100mm
 Material : Aluminium

► STANDARD ACCESSORIES

- Carrying case



Product Link

PRODUCT NAME	MODEL	PKG QTY	MOQ	CODE NO.	C/O
Bipod for Staves	PFS	4	4	218905	TW

Staff Button

MG-01 / 02A / 03 / 04

SPARE BUTTON

Spare buttons for long term use.



MG-01



MG-02A
* Protection label-compliant button.



MG-03



MG-04

✓ CHECK

SPARE BUTTON

High durability button for staves with robust structure. Less stress by button break. Even if button is broken, easy to replace it. No need to buy new staff even if breaking just button. Only take a minute to repair it.

► SPECIFICATIONS

MG-01 : for ALM, SUM, ALS series
 MG-02A : for MST, RFC, SWG series, ALG-25Y
 MG-03 : for MTR series
 MG-04 : for ALG(except for 25Y), SUN, STN, ALX series



Product Link

PRODUCT NAME	MODEL	PKG QTY	MOQ	CODE NO.	C/O
Staff Button	MG-01	-	20	000016	TW
Staff Button	MG-02A	-	20	000017	TW
Staff Button	MG-03	-	20	000018	TW
Staff Button	MG-04	-	20	222050	TW

Button Protection Label

MG-02PS



✓ CHECK

Button protection label prevents the inflow of dust & sand into the staff.

* Use with MG-02A



► SPECIFICATIONS

Suitable staff : MST, RFC, SWG series, ALG-25Y with MG-02A

PRODUCT NAME	MODEL	PKG QTY	MOQ	CODE NO.	C/O
Button Protection Label	MG-02PS	-	4	218385	TW

Ground Plate

GP series



GP-STP430



GP-C

► SPECIFICATIONS

Model GP-STP430 GP-C
 Weight 0.43g 4.10kg



Product Link

PRODUCT NAME	MODEL	PKG QTY	MOQ	CODE NO.	C/O
Ground Plate (Steel)	GP-STP430	-	1	221269	JP
Ground Plate (Ceramic)	GP-C	-	1	210406	JP
Shoe for GP-C	GP-CP	-	1	218924	JP

Staff Case

AS series

CARRYING AROUND

Easy to carry around by AS series.



AS01S

PRODUCT NAME	MODEL	PKG QTY	MOQ	CODE NO.	C/O
Staff Case 1,330mm	AS01S	-	10	219322	TW
Staff Case 1,325mm	AS02S	-	10	011055	TW
Staff Case 2,025mm	AS03S	-	10	240019	TW
Staff Case 1,310mm	AS04S	-	10	217928	TW

✓ CHECK

CARRYING AROUND

AS series has pocket for putting circular level, or spare button. AS series cover all type of Myzox staff. (AS series is an optional item.)

► SPECIFICATIONS

AS01S : for MST, ALG, SUM series
 AS02S : for ALM series
 AS03S : for ALS series
 AS04S : for ALX series

TRIPOD 1
 PRISM 2
 POLE 3
 STAFF 4
 GNSS ACCESSORY 5
 SURVEYING / LASER INSTRUMENT 6
 SURVEYING ACCESSORY 7
 MEASURING TOOL 8
 TESTING INSTRUMENT 9
 SECURITY GOODS 10

Circular Level for Staff

Circular Levels

VARIETY OF LINE UP

There must be suitable circular level for staves in Myzox's line up.

✓ CHECK

VARIETY OF LINE UP

Circular levels show if your staff is in the level or not.

Variety of line up: directly insert to staff, holding by arm and attaching by velcro tape. Also, bubble sensitivity is selectable.



Product Link

PRODUCT NAME	MODEL	PKG QTY	MOQ	CODE NO.	C/O
Circular Level (60'/2mm) Standard type	SA-60	-	10	111114	CN
Circular Level (60'/2mm) Wide type	SB-60	-	10	111115	CN
Circular Level (46'/2mm)	SC-40	-	10	210100	TW
Circular Level (60'/2mm) with band	RL-60T	-	10	217353	CN
Circular Level (60'/2mm) Handheld type	RL-60	-	10	111113	CN
Circular Level (40'/2mm) with band	RL-40TS	-	10	218860	CN

► SPECIFICATIONS

	SA-60	SB-60	SC-40
Model	SA-60	SB-60	SC-40
Sensitivity	60' / 2mm	60' / 2mm	46' / 2mm
Suitable staff	ALG, SUN, STN, MST series	ALM, SUM, ALS series	ALG, STN, MST, RFC, SWG series

	RL-60T	RL-60	RL-40TS
Model	RL-60T	RL-60	RL-40TS
Sensitivity	60' / 2mm	60' / 2mm	40' / 2mm
Suitable staff	All Staves & Poles	All Staves	All Staves, Poles, DM Pin Poles

Aluminium Display Stand

MSS-03

DISPLAY STAND

Display and stockable stand.



* No products included

✓ CHECK

DISPLAY STAND

Good for display use in a shop or showroom.
Also, easy to stock many kind of staves and poles as one.
Can be attached hooks for small item.

► SPECIFICATIONS

Length : 375mm
Height : 1,610mm
Width : 295mm
Hook : 500mm x 16

PRODUCT NAME	MODEL	PKG QTY	MOQ	CODE NO.	C/O
Display Stand	MSS-03	1	1	217259	TW

Rebar Photo Marker

TFM series

PHOTO RECORD

For the photo record of construction process management.

✓ CHECK

In Japan, construction manager must take photos as construction process management.

TFM series can be used to record the interval of rebars.

Without TFM series, it's difficult to discriminate targeted rebars.



The rib holds rebars tightly.

► FEATURES

• Vivid colors bring rebars into clear view.

► SPECIFICATIONS

Length : 50mm
Weight : 41g
Size : 10~30mm φ
Material : PVC



Product Link

PRODUCT NAME	MODEL	PKG QTY	MOQ	CODE NO.	C/O
Rebar Photo Marker Yellow	TFM-Y	10	100	220849	JP
Rebar Photo Marker Pink	TFM-P	10	100	220850	JP
Rebar Photo Marker White	TFM-W	10	100	220851	JP
Rebar Photo Marker Red	TFM-R	10	100	220852	JP
Rebar Photo Marker Blue	TFM-B	10	100	220853	JP
Rebar Photo Marker Green	TFM-G	10	100	220854	JP
Rebar Photo Marker Orange	TFM-O	10	100	220855	JP

Aluminium Photo Rod

N series

PHOTO RECORD

N series is the best for photo records of evidence of your working field.

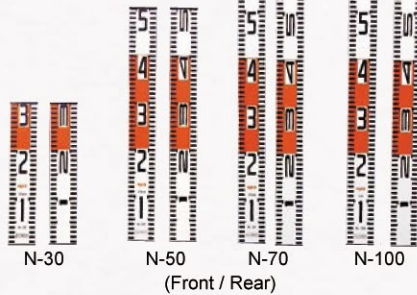
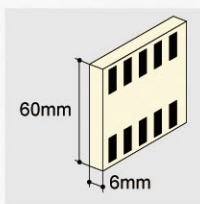

▶ SAMPLE OF USE



▶ POINT CLIP

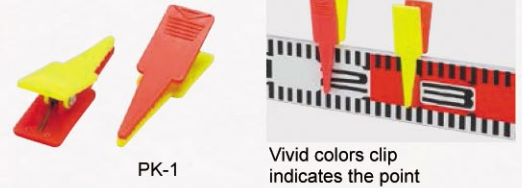

PK-1

Vivid colors clip indicates the point

▶ SPECIFICATIONS

PRODUCT NAME	MODEL	PKG QTY	MOQ	CODE NO.	C/O
Aluminium Photo Rod 30cm	N-30	20	20	021012	TW
Aluminium Photo Rod 50cm	N-50	20	20	021011	TW
Aluminium Photo Rod 70cm	N-70	20	20	021010	TW
Aluminium Photo Rod 100cm	N-100	20	20	021009	TW
Aluminium Photo Rod 110cm	N-110	20	20	021013	TW
Aluminium Photo Rod 150cm	N-150	10	10	021008	TW
Aluminium Photo Rod 200cm	N-200	10	10	021014	TW
Point Clip × 4	PK-1	12	12	210813	TW

Model	N-30	N-50	N-70	N-100
Length	30cm	50cm	70cm	100cm
Weight	113g	183g	260g	360g
Material	Aluminium	Aluminium	Aluminium	Aluminium

Model	N-110	N-150	N-200
Length	110cm	150cm	200cm
Weight	407g	533g	689g
Material	Aluminium	Aluminium	Aluminium

Aluminium Photo Rod Set

NAR-5set

ALL-IN ONE

4 types of N series + K-type joint×2 in a case for NAR-5set.



N-30 (30cm)



N-50 (50cm)



N-70 (70cm)



N-100 (100cm)



NAR-CAS2



K-type joint



✓ CHECK

K-type joint

For cross using / Stainless



▶ SPECIFICATIONS

Photo rod
 Material : Aluminium
 Width : 60mm
 Thickness : 6mm
 Set weight : 1,248g

NAR-CAS2
 Length : 1,100mm

▶ CONTENTS

- N-30 / N-50 / N-70 / N-100 ×1
- K-type joint × 2
- Case (NAR-CAS2)

PRODUCT NAME	MODEL	PKG QTY	MOQ	CODE NO.	C/O
Aluminium Photo Rod Set	NAR-5set	10	10	021007	TW
Case for NAR-5set	NAR-CAS2	10	10	221319	TW
K-type Joint	K-type	1	5	021055	TW

Magnetic Joint for Photo Rod

MP series

MAGNETIC JOINT

MP series helps to attach rods to rebars.

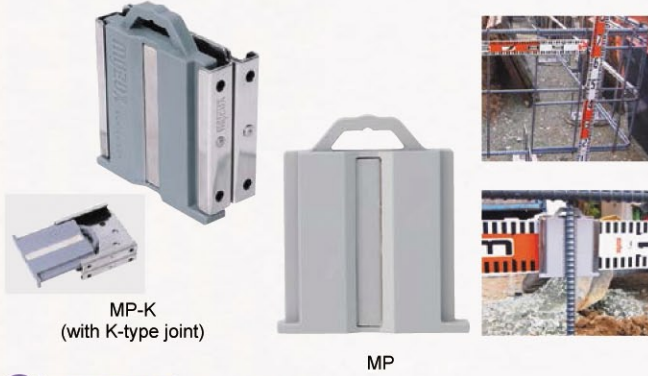

MP-K
(with K-type joint)

MP

CHECK

MAGNETIC JOINT

Easy to attach rods to rebar by its magnet.
Suitable for photo shot to confirm interval sizes of rebars.
MP-K holds two rods and able to show cross way.

SPECIFICATIONS

Model	MP-K	MP
Weight	189g	56g
Material	Magnet & Plastic	Magnet & Plastic
Rebar size	10 ~ 25mm φ	10 ~ 25mm φ

PRODUCT NAME	MODEL	PKG QTY	MOQ	CODE NO.	C/O
Magnetic Joint with K-type Joint	MP-K	1	10	219020	CNTW
Magnetic Joint	MP	1	10	219021	CN

Rod Stand

KS / RS series



KS

SPECIFICATIONS

Weight : 942g

* This stand is for N series photo rod.



RS-B

SPECIFICATIONS

Hole Size : 3 ~ 8mmφ
Weight : 125g



RS-A

SPECIFICATIONS

Weight : 114g

REMARKS

• 2pcs per pack



RS-C

SPECIFICATIONS

Material : Plastic
Hole Size : 3 ~ 6mmφ
Weight : 45g

REMARKS

• 2pcs per pack

PRODUCT NAME	MODEL	PKG QTY	MOQ	CODE NO.	C/O
Rod Stand	KS	1	10	021050	JP
Rod Stand	RS-A	1	10	210814	JP
Rod Stand	RS-B	1	10	210815	JP
Rod Stand	RS-C	1	10	211753	JP

Eco Tape Rod

HPR series

FAVORITE LENGTH

HPR series can be cut on your favorite length.



HPR520 (1cm)



HPR530 (1cm)



HPR752 (1cm)



HPR602T (5mm)

PRODUCT NAME	MODEL	PKG QTY	MOQ	CODE NO.	C/O
Eco Tape Rod 50mm (Color Interval 20cm)	HPR520	5	20	215568	CN
Eco Tape Rod 50mm (Color Interval 30cm)	HPR530	5	20	215888	CN
Eco Tape Rod 75mm (Color Interval 20cm)	HPR752	5	20	216557	CN
Eco Tape Rod 75mm (Color Interval 30cm)	HPR753	5	20	216558	CN
Eco Tape Rod 60mm (Color Interval 20cm)	HPR602T	5	20	216559	CN

EXAMPLE OF USE



CHECK

HPR series can be put directly on the wall, building material, or cutting board.



FEATURES

- Resistant to water and sunlight
- Able to affix, cut, and write
- Harmful substances are not released when it is burned

SPECIFICATIONS

Model	HPR520	HPR530	HPR752
Length	25m	25m	25m
Width	50mm	50mm	75mm
Color interval	20cm	30cm	20cm

Model	HPR753	HPR602T
Length	25m	25m
Width	75mm	60mm
Color interval	30cm	20cm (Numbering)

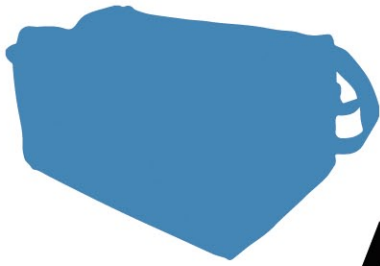

05 GNSS ACCESSORY

- Carbonfiber Pole P074
- Bipod P075
- Clamp Holder for Smart Device P076
- GNSS Receiver Case /
Tribrach / Adapter P078
- GNSS Pole P080



TRIPOD 1

PRISM 2

POLE 3

STAFF 4

GNSS ACCESSORY 5

SURVEYING / LASER INSTRUMENT 6

SURVEYING ACCESSORY 7

MEASURING TOOL 8

TESTING INSTRUMENT 9

SECURITY GOODS 10

Carbonfiber Pole Telescopic type

RCP-260

RTK SURVEY

Suitable model for RTK survey is RCP-260.



*Bipod is an optional product.

PRODUCT NAME	MODEL	PKG QTY	MOQ	CODE NO.	C/O
Carbonfiber Pole	RCP-260	10	10	500293	CN
Case for RCP-260	RCP-260-C	10	10	222165	CN
Replacement Shoe for RCP-260	RCP-1	-	1	219266	CN
Flat Shoe for RCP-260	RCP-2	-	1	221509	CN



✓ CHECK

SUITABLE FOR RTK SURVEY
Durable body with an extra thickness to carbon-fiber material. The shoe is made of stainless and it is resistant to corrosion.

Pole Wall Thickness 2mm
Corrosion-resistant Shoe Stainless made

- **SPECIFICATIONS**
- Full extended : 2,600mm
 - Full closed : 1,480mm
 - Screw : 5/8 inch male
 - Weight : 1.20kg
 - Graduation : Metric (5mm)
- **STANDARD ACCESSORIES**
- Carrying case



All Carbonfiber Pole Joint type

RCP-200J/300J

CARRY FRIENDLY POLE

Joint type RTK pole, carry easily.

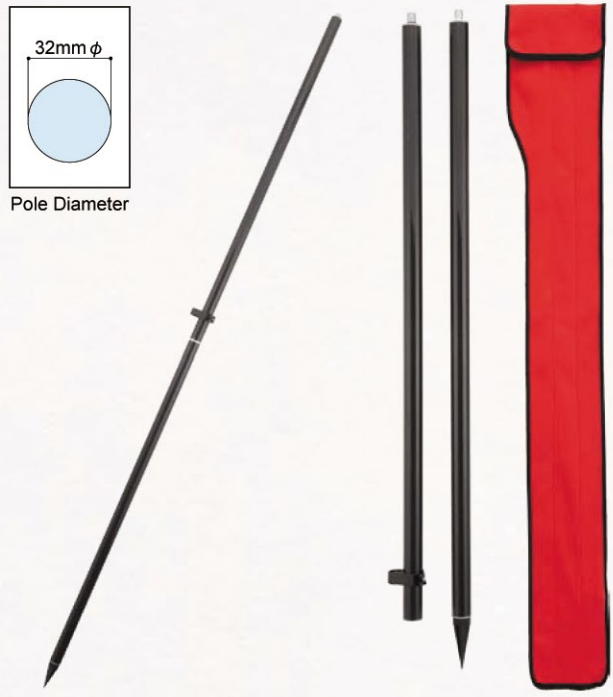

PRODUCT NAME	MODEL	PKG QTY	MOQ	CODE NO.	C/O
Carbonfiber Pole / 2,000mm	RCP-200J	10	10	219346	CN
Carbonfiber Pole / 3,000mm	RCP-300J	10	10	219377	CN



✓ CHECK

CARRY FRIENDLY POLE
Joint type RTK pole with all carbon-fiber material brings you a light and easy carrying. Easy setting and the built-in level brings a relief not to loose it at fields.

- **SPECIFICATIONS**
- | Model | RCP-200J | RCP-300J |
|---------------|---------------|---------------|
| Full extended | 2,000mm | 3,000mm |
| Section | 2m / 2sec. | 3m / 3sec. |
| Screw | 5/8 inch male | 5/8 inch male |
| Weight | 650g | 900g |
- **STANDARD ACCESSORIES**
- Carrying case



All Carbonfiber Pole Telescopic type

RCP-200T/260T

ADDITIONAL STABILITY

All carbon telescopic pole brings additional stability.



Ring lock



5/8 inch screw

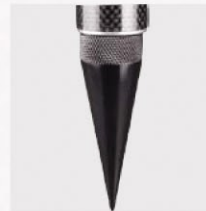

Corrosion-resistant shoe



Built-in circular level (20' / 2mm)

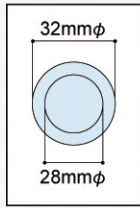

Pole Diameter

CHECK

ADDITIONAL STABILITY

Carbonfiber is lightweight and robust. Comparing with "Steel" material, the performance is reported as following situation.

Weight

1 / 3

Strength

x 10

Elasticity

x 7

And RCP-200T / 260T has "Ring Lock" which minimizes axial eccentricity.

SPECIFICATIONS

Model	RCP-200T	RCP-260T
Full extended	2,000mm	2,600mm
Full closed	1,150mm	1,480mm
Screw	5/8 inch male	5/8 inch male
Weight	1.00kg	1.30kg

STANDARD ACCESSORIES

- Carrying case



Product Link

PRODUCT NAME	MODEL	PKG QTY	MOQ	CODE NO.	C/O
Carbonfiber Pole / 2,000mm	RCP-200T	10	10	219383	CN
Carbonfiber Pole / 2,600mm	RCP-260T	10	10	219378	CN

Bipod

BIP-180

THUMB RELEASE

It is easy to get the level by thumb release.



* The pole is an optional product.

Rustproof stainless shoe

CHECK

QUICK THUMB RELEASE

It's easy to set up as leveling with one push on quick thumb release.



SPECIFICATIONS

Full extended	: 1,800mm
Full closed	: 1,064mm
Weight	: 2.5kg
Pole size	: 21 ~ 38mm φ
Material	: Aluminium

STANDARD ACCESSORIES

- Carrying case



Product Link

PRODUCT NAME	MODEL	PKG QTY	MOQ	CODE NO.	C/O
Bipod	BIP-180	4	4	217426	CN
Case for BIP-180	BIP-180-C	10	10	221995	CN
Replacement Shoe for BIP-180	BIP-1	-	1	219118	CN

Case for RTK Pole & Bipod

RB-C

CARRY WHOLE UNIT

Improving working efficiency by carrying whole unit.



CHECK

CARRY WHOLE UNIT

RB-C can store the bipod & RTK pole. It's easy to carry around and set up at field.

SPECIFICATIONS

Length : 1,890mm

PRODUCT NAME	MODEL	PKG QTY	MOQ	CODE NO.	C/O
RTK Pole & Bipod Case	RB-C	10	10	219405	CN

NEW Smartphone Bracket for DM Pin Pole 6mm φ DM-SH6

BEST MATCH WITH LAYOUT NAVIGATOR
Put the smartphone at your favorite position on DM pole.



✓ CHECK

ADJUSTABLE WIDTH AND NAIL

Width available at 58 ~ 85mm and release easily by unlock button.
Nail position can be changed to avoid contacting with switches or other terminals of smartphone.



✓ CHECK

V SHAPE PLATE

V shape plate protects the smartphone and prism from dirt or damage when putting on the ground.



▶ SPECIFICATIONS

Clamping width : 58 ~ 85mm
Suitable pole : DM pin pole 6mm φ
Dimensions : W135 x H160 x D135mm
Weight : 290g

▶ STANDARD ACCESSORIES

- Silicon tether
- V shape plate (with screw)
- Manual



PRODUCT NAME	MODEL	PKG QTY	MOQ	CODE NO.	C/O
Smartphone Bracket for DM Pole	DM-SH6	1	10	222172	CN
DM Pin Pole 6mm φ (Ref. Page 048)	DMP-6-800	1	10	221552	JP

NEW Controller Bracket CRL series

UNIVERSAL CONTROLLER CLAMP
Adjustable clamp can hold any type of GNSS controllers.

✓ CHECK

ADJUSTABLE CLAMP (CRL-CLM)

Clamp width and the depth are adjustable by hex screw.
CRL-CLM can be used for almost all types of controller.

*Controllers below are confirmed.

Topcon	Sokkia	Leica
GRS-1	SHC250	CS10
FC-250	SHC500	CS15
FC-500	S-10	
S-10		



✓ CHECK

ANGLE ADJUSTABLE

CRL-CLA : High flexibility by ball joint
CRL-CLM : 7 grade
CRL-TP : 7 grade



▶ SPECIFICATIONS

Model	CRL-CLM	CRL-CLA
Size	approx. 215 x 110 x 45 mm	approx. 280 x 120 x 40 mm
Weight	approx. 340 g	approx. 450 g
Pole	30 ~ 33mm φ	32 ~ 34mm φ
Device	Controller / Smartphone (W: 67 ~ 100mm, D: 40 ~ 55mm)	Controller: GRS-1 type

Model	CRL-TP
Size	approx. 235 x 122 x 45 mm
Weight	approx. 360 g
Pole	30 ~ 33mm φ
Device	7inch tablet (W: 100 ~ 140mm, D: up to 35mm)

+1 OPTION

Adapter for DM Pin Pole COV9
For DM Pin Pole (9mm φ) use

+1 OPTION

Field Controller Adapter CRL-HAP
Adapter for horizontal use

CRL-CLM for Controller and Smartphone

CRL-CLA for GRS-1 type

CRL-TP for 7inch tablet

PRODUCT NAME	MODEL	PKG QTY	MOQ	CODE NO.	C/O
Controller Bracket M	CRL-CLM	1	10	220990	CN
Controller Clamp A	CRL-CLA	1	10	219366	CN
Field Controller Bracket	CRL-TP	1	10	221997	CN
Field Controller Adapter	CRL-HAP	1	10	221998	CN
Adapter for DM Pin Pole (9mm)	COV9	1	10	221878	JP

NEW X grip for Smartphone
RAM-HOL-UN10BU

EASY SET UP & STABLE
Just 5 minutes to mount the mobile.



+1 OPTION

Attach to a Tripod Leg / Pole

Double Socket Arm
RAM-B-201U
* for 1" ball



Pole Clamp
RAP-B-400U



▶ **SPECIFICATIONS (RAM-HOL-UN10BU)**
Width : approx. 45 ~ 114mm
Depth : approx. up to 22mm

* When using this product at the minimum width 45mm, the height needs to be over 140mm.

▶ **STANDARD ACCESSORIES**
• Rubber tether

Device Examples

- iPhone 7 (Plus)
- iPhone 6 (Plus)
- iPhone 6s (Plus)
- Nexus 7

PRODUCT NAME	MODEL	PKG QTY	MOQ	CODE NO.	C/O
X grip for Smartphone	RAM-HOL-UN10BU	1	10	222227	US
Double Socket Arm	RAM-B-201U	1	10	222267	US
Pole Clamp for Tripod Leg / Pole Use	RAP-B-400U	1	10	222229	US
Adapter for DM Pin Pole (9mm)	COV9	1	10	221878	JP

NEW Laptop Holder
RAM-234-3

ACCOMMODATE TABLET AND LAPTOP
Compatible with TOUGH PAD that have optional tall corner guards.



+1 OPTION

Attach to a Tripod Head

Double Socket Arm
with Bases
RAM-101U-B
* 1.5" ball



Mount Base
MB



▶ **SPECIFICATIONS (RAM-234-3)**
Height : approx. over 130mm
Width : approx. 254 ~ 406mm
Depth : approx. 12.7 ~ 44.5mm

* Attach the Laptop Holder to a tripod leg / pole is not recommended.

Device Examples

- Laptop / Tablet from 10 to 16 inch

PRODUCT NAME	MODEL	PKG QTY	MOQ	CODE NO.	C/O
Laptop Holder	RAM-234-3	1	2	222226	US
Double Socket Arm with Base (1.5" ball)	RAM-101U-B	1	2	222230	US
Mount Base for Tripod Head Use	MB	1	2	222231	US

NEW Tablet Holder
RAM-HOL-TAB19U / RAM-HOL-TAB12U

GOES WELL WITH TOUGH PAD
Dedicated holder for tablets with 7 or 10 inch display.



+1 OPTION

Attach to a Tripod Leg / Pole



Double Socket Arm
with Round Base
RAM-B-103U



Pole Clamp
RAP-B-400U

* Tablet Holder Unit (TAB-10 / TAB-7) is a set for pole use.

Attach to a Tripod Head

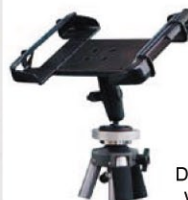

Double Socket Arm
with Round Base
RAM-B-103U



Round Base
RAP-B-202U



Mount Base
MB

Device Examples

- TOUGH PAD
 - FZ-G1 (10 inch)
 - FZ-A2 (10 inch)
 - FZ-M1 (7 inch)
 - FZ-B2 (7 inch)
- iPad mini (7 inch)

PRODUCT NAME	MODEL	PKG QTY	MOQ	CODE NO.	C/O
Tablet Holder (10inch)	RAM-HOL-TAB19U	1	10	222224	US
Tablet Holder (7inch)	RAM-HOL-TAB12U	1	10	222225	US
Tablet Holder Unit (10inch) for Pole Use	TAB-10	1	10	222084	US
Tablet Holder Unit (7inch) for Pole Use	TAB-7	1	10	222086	US
Double Socket Arm with Round Base	RAM-B-103U	1	10	222228	US
Round Base	RAP-B-202U	1	10	222268	US
Pole Clamp for Tripod Leg / Pole Use	RAP-B-400U	1	10	222229	US
Mount Base for Tripod Head Use	MB	1	2	222231	US

▶ **SPECIFICATIONS**

Model	RAM-HOL-TAB19U (10inch)	RAM-HOL-TAB12U (7inch)
Height	approx. 273 ~ 340mm	approx. 181 ~ 241mm
Width	approx. 165 ~ 197mm	approx. 129 ~ 144mm
Depth	approx. 3.3 ~ 23.6mm	approx. 3.3 ~ 25.4mm

* RAM-HOL-TAB19U will not work when using the optional tall corner guards, SmartCard reader, long life battery and / or rotating hand strap.

* RAM-HOL-TAB12U is not compatible with the iPad mini 1-3 with LifeProof case.

TRIPOD
PRISM
POLE
STAFF
GNSS ACCESSORY
SURVEYING / LASER INSTRUMENT
SURVEYING ACCESSORY
MEASURING TOOL
TESTING INSTRUMENT
SECURITY GOODS

GNSS Receiver Case

M-GPC

EASY TO BRING TO FIELD

M-GPC can bring whole units for GNSS accessories at one time.



Rucksack



Hand carry



Sling



Removable partition to get your favorite room

CHECK

EASY TO BRING TO FIELD

Designed for RTK surveying; M-GPC has rooms for antenna, controller, adapters and tribrach. Easy to arrange room inside of case and able to make your own arrangements.

SPECIFICATIONS

Dimensions : 450(W) x 235(H) x 300(D)mm
 Internal dimensions : 440(W) x 180(H) x 250(D)mm
 Carrying belt : 1,100 ~ 1,650mm
 Weight : 2.00kg

PRODUCT NAME	MODEL	PKG QTY	MOQ	CODE NO.	C/O
GNSS Receiver Case	M-GPC	2	4	240025	CN

NEW Tribrach with Optical Plummet MY011BO / YO

CLEAR & EASY ADJUSTMENT

Available to use for GNSS instruments



MY011BO



MY011YO

SPECIFICATIONS

Material : Aluminum
 Plummet : Optical
 Circular level : 8' / 2mm
 Color : Yellow / Black
 Locking screw : 5/8 inch female



Bright field of view (Optical plummet)

PRODUCT NAME	MODEL	PKG QTY	MOQ	CODE NO.	C/O
Tribrach with Optical Plummet / Black	MY011BO	1	10	240003	CN
Tribrach with Optical Plummet / Yellow	MY011YO	1	10	222271	CN

NEW Spigot type Pole Adapter LSP100

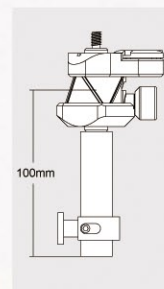

SPECIFICATIONS

Size : 25 x 27 x 135mm
 Weight : 74g

PRODUCT NAME	MODEL	PKG QTY	MOQ	CODE NO.	C/O
Spigot type Pole Adapter	LSP100	1	10	222281	CN

NEW Mini Prism Adapter MAG50



MAG50



MAG50 + Z-220 + Instrument



MAG50 + DMP-M6

SPECIFICATIONS

Pole length : 60mm
 Pole diameter : 9mm φ
 Screw : 5/8 inch female
 Use with tribrach : Yes

PRODUCT NAME	MODEL	PKG QTY	MOQ	CODE NO.	C/O
Mini Prism Adapter	MAG50	1	10	221851	CN
Shoe / female	DMP-M6	-	5	219524	JP

Tribrach & Height Adapter

MG030 series

HIGH VISIBILITY

MG030 series has high brightness & center circle of view from optical plummet.



MG030S



Scale of height adapter



MG030G

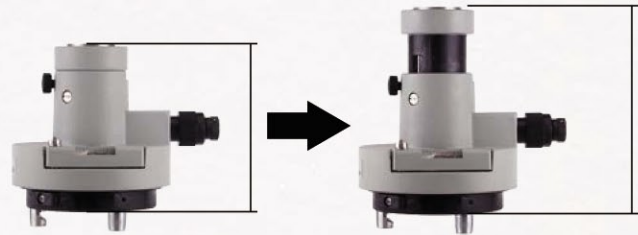

Full closed : 98mm

Full extended : 121mm

Height adjustable : 23mm

✓ CHECK

HIGH VISIBILITY

The view from optical plummet is bright, and there is a center circle. It's easy to aim measuring point by brightness, and set measuring at measuring point exactly.

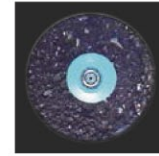

PRODUCT NAME	MODEL	PKG QTY	MOQ	CODE NO.	C/O
Tribrach & Height Adapter / Yellow	MG030S	6	6	219324	CN
Tribrach & Height Adapter / Gray	MG030G	6	6	217907	CN
Adapter for Tribrach	5/8 inch Adapter	-	10	221340	CN

SPECIFICATIONS

Model	MG030S	MG030G
Adjustable range	23mm	23mm
Circular level	8' / 2mm	8' / 2mm
Tubular level	60" / 2mm	60" / 2mm



Product Link

NEW Tribrach Adapter with Removable Center with Lock TAR / TAF

SIMPLE TO SET UP

Easy to detach GNSS receiver while GNSS surveying.



TAR



TAF

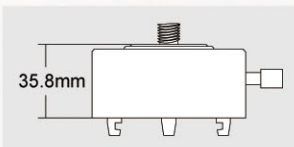

35.8mm

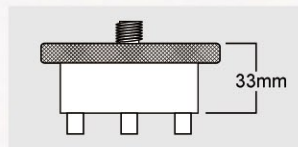

33mm

FEATURES

- Easy to detach receiver from tribrach
- Removable center (TAR)

SPECIFICATIONS

Model	TAR	TAF
Size	approx. 97 x 79 x 63 mm	approx. 95 x 95 x 55 mm
Weight	approx. 565 g	-

PRODUCT NAME	MODEL	PKG QTY	MOQ	CODE NO.	C/O
Tribrach Adapter	TAR	1	10	240041	CN
Tribrach Adapter Friction type	TAF	1	10	221946	CN

Adapter

QDA / SPA100

EXTRA ACCURACY

Receiving more GNSS signal by adding 100mm adapter.



QDA



Example of use with GNSS receiver

✓ CHECK

QUICK THUMB RELEASE SYSTEM (QDA)

It's quick and easy to detach by thumb release system.



SPA100



100mm

100 mm distance prevent from interfering signal

SPECIFICATIONS

Model	QDA	SPA100
Size	approx. 110 x 35 x 26 mm	approx. 100 x 25 x 25 mm
Weight	approx. 80 g	approx. 110 g

PRODUCT NAME	MODEL	PKG QTY	MOQ	CODE NO.	C/O
Quick Adapter	QDA	1	10	240026	CN
Pole Adapter	SPA100	1	10	240042	CN

GNSS Receiver Pole

SKY LIFTER 3

THE LONGEST POLE

Extendable up to 15m with additional poles.



SKY-LF



Parts (5m)

► SPECIFICATIONS

- Antenna height : 2 ~ 15m (1m joint type)
*up to 15m if using optional poles
- Body weight : 10kg
- Pole weight : 870g / 1pc
- Pole material : Aluminium

► ATTACHED ITEMS (SKY-LF)

- Main body
- Centripetal disc
- Elevating handle
- Antenna adapter
- Bag for main body
- 5m pole (1m x 5)
- Adapter for measuring point
- Antenna pole set
- Anchor wire x 4
- Branch line adapter
- Branch line wire set x 4
- Turnbuckle x 4
- Winder for branch line

► REMARKS

- All include package (SKY-LF)
- Additional Poles (1m x 5pcs) (SKY-PL)

✓ CHECK

THE LONGEST POLE

Extendable up to 15m with additional poles.
Easy to extend by handling systems and no need to set GNSS from high-position.
Sustain wires comes with and bring much stability.

PRODUCT NAME	MODEL	PKG QTY	MOQ	CODE NO.	C/O
Sky Lifter 3	SKY-LF	1	1	102535	JP
Additional Poles	SKY-PL	1	1	102536	JP

GNSS Receiver Pole

MG SATELLITE POLE

MAKING EXTRA HEIGHT

Making extra height by easy setting with jointable pole.



* Full extended : 2m

► CONTENTS (GPS-P02)



Attachment
5/8 inch
(MY-AT)



Tip adapter
(MY-ADP)



Aluminium pole
40mm φ
(MY-PL)

✓ CHECK

MAKING EXTRA HEIGHT

Only need tribrach and tripod to set up GNSS antenna at high position, up to 2m. Yellow color body is easy to find from far away.
Recommended height is up to 2m by pole joint.

PRODUCT NAME	MODEL	PKG QTY	MOQ	CODE NO.	C/O
MG Satellite Pole	GPS-P02	1	1	102473	JP
Tip Adapter	MY-ADP	1	1	102527	JP
1m Pole x 2pcs with Carrying Case	MY-PL	1	1	102528	JP
Attachment	MY-AT	1	1	102529	JP
1m Pole x 1pc	MY-PL1	1	1	218591	JP
Carrying Case for Pole	MY-PLC	1	1	218592	JP



06

SURVEYING/ LASER INSTRUMENT

- Automatic Level P082
- Digital Theodolite P084
- Green Line Laser P085
- Red Line Laser P088
- Line-Laser Tripod / Detector P090
- Rotating Laser P091
- Elevating Tripod / Scale Staff / Laser Accessory P092



TRIPOD	1
PRISM	2
POLE	3
STAFF	4
GNSS ACCESSORY	5
SURVEYING / LASER INSTRUMENT	6
SURVEYING ACCESSORY	7
MEASURING TOOL	8
TESTING INSTRUMENT	9
SECURITY GOODS	10

Automatic Level Magnetic Damper Model

GEO-MD series

MAGNETIC DAMPER

Magnetic damper absorbs vibration from the ground.



GEO-32MD



GEO-24MD



GEO-28MD

► FEATURES



Aperture



Circular level



Peep sight



Fine adjustment

► FEATURES

- Vibration-resistant by magnetic damper
- Bright and quality lens
- Compact body (Length : 190mm)
- Water & dust resistance IP54

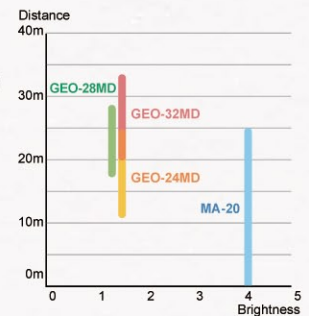

✓ CHECK

MAGNETIC DAMPER

Magnetic damping system quickly levels and stabilizes the line of sight despite the fine vibrations present when working near heavy equipment or busy roadways.

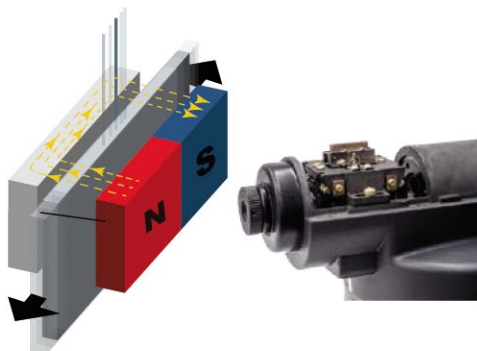

► SPECIFICATIONS

Model	GEO-32MD	GEO-28MD	GEO-24MD
Telescope			
Length	190mm	190mm	190mm
Image	Erect	Erect	Erect
Aperture	40mm	30mm	30mm
Magnifications	32X	28X	24X
Field of view (100m)	1°20'	1°20'	1°20'
Resolution	3.5"	4.5"	4.5"
Minimum focus	0.50m	0.60m	0.60m
Standard deviation for 1km double-run leveling	±1.5mm	±2.0mm	±2.0mm
Stadia ratio	100 / 0	100 / 0	100 / 0
Setting accuracy	±0.5"	±0.5"	±0.5"
Horizontal circle			
Graduation	360°	360°	360°
Minimum reading	1°	1°	1°
Self-Leveling			
Method	Magnetic	Magnetic	Magnetic
Range	±15'	±15'	±15'
Circular level			
Sensitivity	8'/2mm	8'/2mm	8'/2mm
Weight			
Body	1.26kg	1.26kg	1.26kg
Case	0.60kg	0.60kg	0.60kg
Water & dust resistance	IP54	IP54	IP54

► STANDARD ACCESSORIES

- Auto level
- Plumb bob
- Lens cap
- Adjustment tools
- Carrying case

PRODUCT NAME	MODEL	PKG QTY	MOQ	CODE NO.	C/O
Automatic Level 32X	GEO-32MD	4	4	220832	CN
Automatic Level 28X	GEO-28MD	4	4	220831	CN
Automatic Level 24X	GEO-24MD	4	4	220830	CN



Product Link Product movie

Automatic Level

MA-20

ENTRY MODEL

MA-20 is 20X magnification, and good for entry model.



MA-20

► SPECIFICATIONS

Telescope	
Length	: 190mm
Image	: Erect
Aperture	: 40mm
Magnifications	: 20X
Field of view (100m)	: 1°20'
Resolution	: 5"
Minimum focus	: 0.50m
Standard deviation for 1km double-run leveling	: ±2.5mm
Stadia ratio	: 100 / 0
Setting accuracy	: ±0.5"
Horizontal circle	
Graduation	: 360°
Minimum reading	: 1°
Self-Leveling	
Method	: Air damper
Range	: ±15'
Circular level	
Sensitivity	: 8'/2mm
Weight	
Body	: 1.30kg
Case	: 0.66kg
Water & dust resistance	: IP54

► STANDARD ACCESSORIES

- Plumb bob
- Lens cap
- Hard carrying case
- Adjustment tools

► FEATURES



Aperture

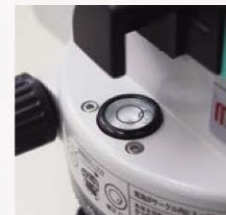

Circular level



Peep sight



Fine adjustment

✓ CHECK

BRIGHT SIGHT

If the brightness is high, you can read the staff easily. To know how much brightness is, it can be calculable by the following formula.

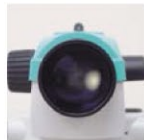

$$\text{BRIGHTNESS} = (\text{Objective aperture} \div \text{Magnification})^2$$

$$\text{MA-20} = (40 \div 20)^2$$

The brightness of MA-20 is " 4 ".
Please compare with the brightness of your instrument.

✓ CHECK

ENTRY MODEL

Easy to focus short distance by 20X magnification, and good enough as entry model of automatic level. 40mm object lens aperture brings bright object and avoiding eyestrain. Specially designed for civil engineering fields and construction sites. Myzox ET or ETQ tripod series fits MA-20 automatic level.

+1 OPTION

Automatic Level MA-20 Package Kit



- + Automatic Level MA-20
- + Aluminium Tripod ET series
- + Aluminium Staff ALX series

* To choose your favorite staff & tripod, please check the product page.
ET series : Page 023
ALX series : Page 063

PRODUCT NAME	MODEL	PKG QTY	MOQ	CODE NO.	C/O
Automatic Level 20X	MA-20	4	4	220369	CN
Automatic Level 20X Package Kit	MA-20 KIT	4	4	-	CN

1 TRIPOD
 2 PRISM
 3 POLE
 4 STAFF
 5 GNSS ACCESSORY
 6 SURVEYING / LASER INSTRUMENT
 7 SURVEYING ACCESSORY
 8 MEASURING TOOL
 9 TESTING INSTRUMENT
 10 SECURITY GOODS

Digital Theodolite

DTC-110

HIGH COST PERFORMANCE

DTC-110 is high cost performance digital theodolite.



DTC-110

SPECIFICATIONS

Telescope	:	Erect
Image	:	30X
Magnification	:	45mm
Aperture	:	3"
Resolution	:	1°30'
Field of view	:	1.35m
Minimum focus	:	100 / 0
Stadia ratio	:	
Optical plummet	:	Erect
Image	:	3X
Magnification	:	over 0.5m
Focusing range	:	5"
Field of view	:	-20 ~ + 50°C
Operating temperature	:	36h (alkaline battery)
Operating time	:	4.8V 1,500mAh
Battery source voltage	:	Single side (V), Both side (H)
Angle detection	:	5" / 10"
Minimum reading	:	10"
Angle measurement accuracy	:	LCD double side
Display	:	30" / 2mm
Tubular level	:	8' / 2mm
Circular level	:	Rechargeable battery / AA alkaline battery x 4
Power	:	Detachable (5/8 model)
Tribrach	:	Undetachable (35mm model)
	:	164 x 154 x 340mm
Dimensions	:	4.60kg (body) , 3.05kg (case)
Weight	:	35mm / 5/8inch female screw
Selectable screw size	:	

STANDARD ACCESSORIES (DTC-110)

- Hard carrying case
- Plumb bob
- Rain cover
- Recharger
- Alkaline batteries

STANDARD ACCESSORIES (DTC-110 KIT)

- DTC-110
- Aluminium tripod SDX tripod

FEATURES



Aperture



Tubular bubble



Peep sight



Optical plummet



Display

CHECK

HIGH COST PERFORMANCE

High cost performance digital theodolite.
 Minimum angle reading is selectable 5" or 10".
 Rechargeable battery and charger are coming with the instrument as standard accessories.
 Enough accuracy and easy to operate for carpentry.
 SDX & LAN series aluminium tripod are suitable for DTC-110.
 2 types of holding screw are available (5/8 inch and 35mm).



Easy to adjust the center point by shifting function (35mm screw type only)

+1 OPTION

Theodolite DTC-110 Package Kit



- + Theodolite DTC-110
- + Aluminium Tripod SDX series

* To choose your favorite tripod, please check the product page.
 SDX series : Page 021

PRODUCT NAME	MODEL	PKG QTY	MOQ	CODE NO.	C/O
Digital Theodolite / 35mm female screw	DTC-110	1	1	217680	CN
Digital Theodolite / 5/8 inch female screw	DTC-110 U	1	1	217680U	CN
Digital Theodolite Package Kit	DTC-110 KIT	1	1	-	CN



Electronic Automatic Green Line Laser

G-440S

AUTOMATIC SELF-LEVELING

Electronic automatic self-leveling green line laser with extra brightness.



G-440S

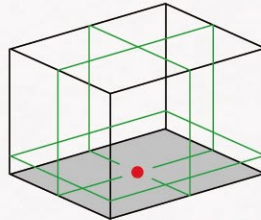

4V4H



GL-RES

GL-RC

▶ FEATURES

- Water & dust resistance IP54
- Simple control panel
- 360° fine rotating adjustment

▶ SPECIFICATIONS

Laser	
Line	: Green (532nm)
Down point	: Red (650nm)
IEC laser class for safe	: Class 2M
Line width	: within 2.5mm / 5m
Fan angle (for vertical)	: approx. 130°
Fan angle (for horizontal)	: approx. 120°
Down point diameter	: approx. 1.5mm φ / 1m
Line accuracy	: ±1mm / 10m
Mechanism	: X / Y 2-axis electric system
Self-leveling range	: ± 2.0°
Operating temperature	: 0 ~ + 40°C
Water & dust resistance	: IP54
Power	: AA battery x 4 AC adapter
Operating time (all lines)	: approx. 2h
Dimensions	: 152 x 148 x 223mm
Weight	: approx. 1.7kg



▶ STANDARD ACCESSORIES

- Hard carrying case
- AC adapter
- Shoulder strap
- Manual
- AA batteries

▶ SPECIFICATIONS (DETECTOR GL-RES)

Detecting instruction	: High luminance LED and buzzer
Detector accuracy	: ±1mm from the center of laser
Operating distance	: 1 ~ 20m
Operating temperature	: -10 ~ + 50 °C
Power	: 9V alkaline battery x 1
Dimensions	: H150mm x W55mm x D28mm
Weight	: approx. 150g (incl. battery)

* Detector & rod clamp are optional accessories.

✓ CHECK

THE BRIGHTEST LASER LINE

G-440S has the brightest laser module in market.

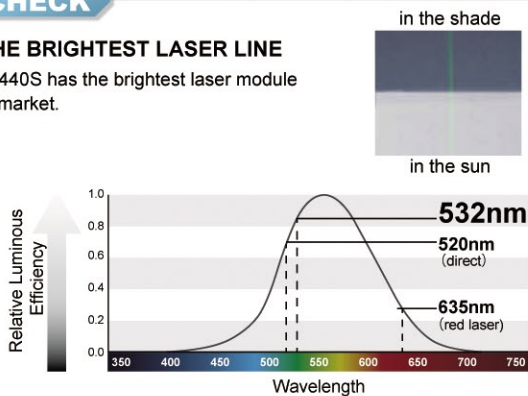

✓ CHECK

AUTOMATIC SELF-LEVELING

G-440S is 4V4H full-automatic leveling system with IP54 structure. Impervious to vibration by the system is good to the construction site. The sophisticated 2 axis electric motor for self-leveling and the parts shaped accurately by CNC lathe bring ±1mm per 10m accuracy.



Electronic leveling system

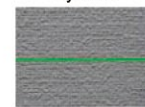

Gimbal system

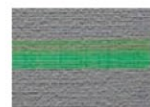

PRODUCT NAME	MODEL	PKG QTY	MOQ	CODE NO.	C/O
Electronic Automatic Green Line Laser	G-440S	4	4	221450	CN
Detector with Clamp	GL-RES / GL-RC	1	4	221444	CN
Elevating Tripod for Laser (Ref. Page 090)	LET-B	6	6	213092	CN

TRIPOD 1
PRISM 2
POLE 3
STAFF 4
GNSS ACCESSORY 5
SURVEYING / LASER INSTRUMENT 6
SURVEYING ACCESSORY 7
MEASURING TOOL 8
TESTING INSTRUMENT 9
SECURITY GOODS 10

NEW Real Green Line Laser G-410S

REAL GREEN LASER

Real green laser has a high temperature stability.



G-410S

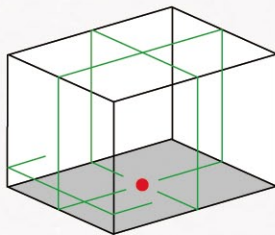

4V1H



GL-RE4

► FEATURES

- Water & dust resistance IP54
- Simple control panel
- 360° fine rotating adjustment

► SPECIFICATIONS

Laser	
Line	: Green (510~530nm)
Down Point	: Red (650nm)
IEC laser class for safe	: Class 2M
Line width	: within 2.5mm / 5m
Fan angle (for vertical)	: approx. 110°
Fan angle (for horizontal)	: approx. 120°
Down point diameter	: approx. 1.5mm ϕ / 1m
Line accuracy	: ± 1 mm / 7.5m
Mechanism	: X / Y 2-axis gimbal system
Braking system	: Magnet damper
Self-leveling range	: $\pm 1.5^\circ$
Operating temperature	: -5 ~ + 40°C
Water & dust resistance	: IP54
Power	: AA alkaline battery x 4
	: AC adapter
Operating time (all lines)	: approx. 2h
Dimensions	: 116 x 115 x 195mm
Weight	: approx. 1,240g

► SPECIFICATIONS(DETECTOR GL-RE4)

Detecting instruction	: High luminance LED and buzzer
Detector accuracy	: ± 1 mm from the center of laser
Operating distance	: 1 ~ 20m
Operating temperature	: -10 ~ + 50 °C
Power	: 9V alkaline battery x 1
Dimensions	: H150mm x W55mm x D28mm
Weight	: approx. 150g (incl. battery)

* Detector & rod clamp are optional accessories.

✓ CHECK

REAL GREEN

Wide Temperature Range

Compared to converted green laser, real green laser have a wide operating temperature range.

High Efficient and Long Lifetime

By a good efficiency, the temperature increase of lasers during operation is minimized. A long lifetime and high reliability at continuous operation is guaranteed.

Real Green method

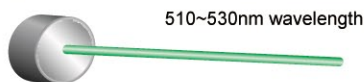

510~530nm wavelength

Converted Green method

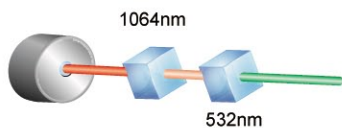

1064nm

532nm



► STANDARD ACCESSORIES

- G-410S
- AC adapter
- Carrying case
- Shoulder strap
- Manual
- AA batteries

+1 OPTION

Elevating Tripod LET-B



LET-B

► SPECIFICATIONS

Model	LET-B
Full extended	1,705mm
Full closed	605mm
Weight	1.34kg
Elevating range	305mm
Screw size	5/8inch

PRODUCT NAME	MODEL	PKG QTY	MOQ	CODE NO.	C/O
Real Green Line Laser	G-410S	4	4	221877	CN
Detector with Clamp	GL-RE4 / GL-RC	1	4	221325	CN
Elevating Tripod for Laser (Ref. Page 090)	LET-B	6	6	213092	CN

Green Line Laser

G-S series

BRIGHT GREEN WITH LONG-LIFE

G-S series has bright green, but the battery life is so long.

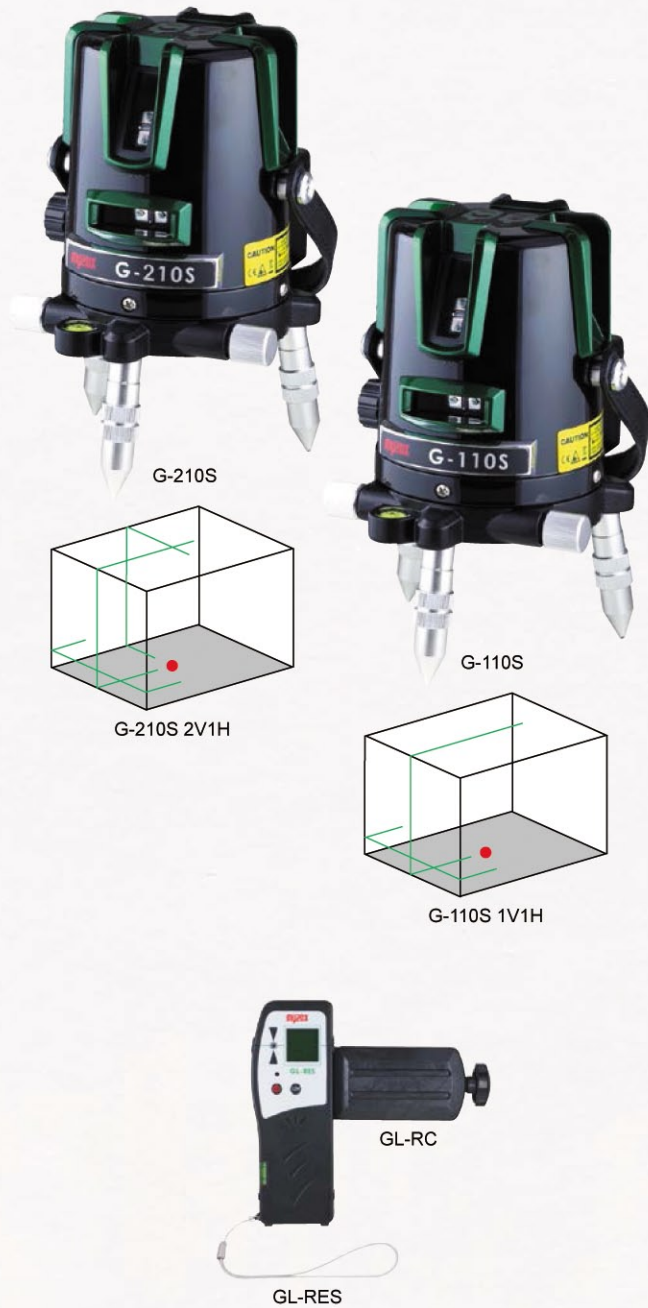

► FEATURES

- 360° Fine rotating adjustment
- Water & dust resistance IP54
- Light & compact body

► SPECIFICATIONS (G-210S / G-110S)

Laser source	: Visible green laser diode
Wavelength	: 532nm (line) 650nm (down point)
Output power	: Maximum 4.5mW (class 2M)
Width of laser line	: within 2.5mm / 5m
Fan angle (for vertical)	: More than 90°
Fan angle (for horizontal)	: approx. 110°
Diameter of down point	: approx. 1.5mm ϕ / 1m
Accuracy	
Vertical & horizontal line	: ± 1 mm / 7.5m
Down point	: ± 1 mm / 1m
Upper cross point	: ± 1 mm / 5m (G-210S)
Right angle	: ± 1 mm / 3m (G-210S)
Circular level	: 120' / 2mm
Mechanism	: X / Y 2-axis gimbal system
Braking system	: Magnetic damper
Self leveling range	: $\pm 2.0^\circ$
Rotating system	: 360° endless drive by adjusting screw
Operating temperature	: 0 ~ + 40°C
Operating range	: 10m or 20m with detector
Water & dust resistance	: IP 54 (except for battery box)
Power	: AA alkaline battery x 4
Operating time (all lines)	: approx. 11 hours (G-110S) approx. 7 hours (G-210S)
IEC laser class for safe	: Class 2M
Dimensions	: approx. 110 x 115 x H165mm
Weight (without batteries)	: approx. 750g

► STANDARD ACCESSORIES

- Carrying case
- Manual
- Alkaline batteries

► SPECIFICATIONS (DETECTOR GL-RES)

Detecting instruction	: High luminance LED and buzzer
Detector accuracy	: ± 1 mm from the center of laser
Operating distance	: 1 ~ 20m
Operating temperature	: -10 ~ + 50 °C
Power	: 9V alkaline battery x 1
Dimensions	: H150mm x W55mm x D28mm
Weight	: approx. 150g (incl. battery)

* Detector & rod clamp are optional accessories.

✓ CHECK

GREEN LINE LASER

Green line laser 2V1H and 1V1H with gimbal system. Compact body and light weight, but emits green laser line which brightness will create efficiency at your work site, especially in bright circumstance such as outside in day time. If the circumstance is too much bright and it is invisible situation even green laser, GL-RES green laser detector catches the line precisely.

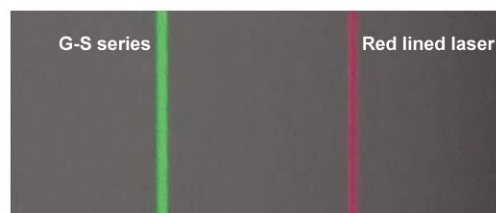

PRODUCT NAME	MODEL	PKG QTY	MOQ	CODE NO.	C/O
Green Line Laser	G-210S	4	4	221359	CN
Green Line Laser	G-110S	4	4	221358	CN
Detector with Clamp	GL-RES / GL-RC	1	4	221444	CN

TRIPOD 1
PRISM 2
POLE 3
STAFF 4
GNSS ACCESSORY 5
SURVEYING / LASER INSTRUMENT 6
SURVEYING ACCESSORY 7
MEASURING TOOL 8
TESTING INSTRUMENT 9
SECURITY GOODS 10

Line Laser Pendulum type Extra Brightness

P-EX series

EXTRA BRIGHTNESS

High visibility red line laser by extra brightness.



P-410EX

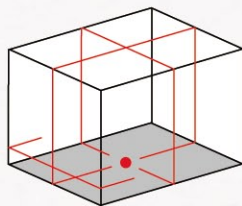

Laser line (P-410EX)

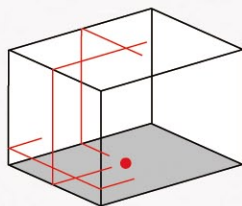

Laser line (P-210EX)

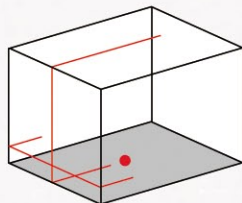

Laser line (P-110EX)



TL-RE



TL-RC

► SPECIFICATIONS (P-410EX / P-210EX / P-110EX)

Laser source	: Visible red laser diode
Wavelength	: 635nm (line) 650nm (down point)
Output power	: Maximum 4.5mW (class 2M)
Width of laser line	: within 1.5mm / 5m
Fan angle (for vertical)	: More than 90°
Fan angle (for horizontal)	: approx. 110°
Diameter of down point	: approx. 1.5mm φ / 1m
Accuracy	
Vertical & horizontal line	: ± 1mm / 7m
Down point	: ± 1mm / 1m
Upper cross point	: ± 1mm / 5m (P-410EX / P-210EX)
Right angle	: ± 1mm / 3m (P-410EX / P-210EX)
Circular level	: 120' / 2mm
Mechanism	: X / Y 2-axis gimbal system
Braking system	: Magnetic damper
Self leveling range	: ± 2.0°
Rotating system	: 360° endless drive by adjusting screw
Operating temperature	: -10 ~ + 40°C
Operating range	: 10m or 20m with detector
Water & dust resistance	: IP 54 (except for battery box)
Power	: AA alkaline battery x 3
Operating time (all lines)	: approx. 3.5 hours (P-410EX) approx. 5.5 hours (P-210EX) approx. 6.0 hours (P-110EX)
IEC laser class for safe	: Class 2M
Dimensions	: approx. 110 x 115 x H165mm
Weight (without batteries)	: approx. 900g (P-410EX) approx. 880g (P-210EX) approx. 870g (P-110EX)



► STANDARD ACCESSORIES

- Hard carrying case
- Alkaline batteries

► SPECIFICATIONS (DETECTOR TL-RE)

Detecting instruction	: High luminance LED and buzzer
Detector accuracy	: ±1mm from the center of laser
Operating distance	: 1 ~ 20m
Operating temperature	: -10 ~ + 50°C
Power	: 9V alkaline battery x 1
Dimensions	: H150mm x W52mm x D26mm
Weight	: approx. 140g (incl. battery)
Detection mode	: Short / long distance selectable

* Detector & rod clamp are optional accessories.

✓ CHECK

EXTRA BRIGHTNESS

P-EX have 4V1H, 2V1H and 1V1V models with gimbal system in a series.

It is compact body & light weight, but emits the brightest red laser line as class 2M laser by 15mW laser module.

Even if under the bright situation, you can catch the line by detector TL-RE.

TL-RE can select the detection mode for short or long distances.

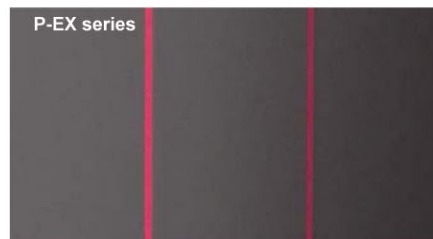

PRODUCT NAME	MODEL	PKG QTY	MOQ	CODE NO.	C/O
Line Laser / 4V1H	P-410EX	4	4	219300	CN
Line Laser / 2V1H	P-210EX	4	4	219301	CN
Line Laser / 1V1H	P-110EX	4	4	219302	CN
Detector with Clamp	TL-RE / TL-RC	1	4	216601	CN

Electronic Automatic Line Laser Extra Brightness

P-440EX

AUTOMATIC SELF-LEVELING

Electronic automatic self-leveling red line laser with extra brightness.



P-440EX

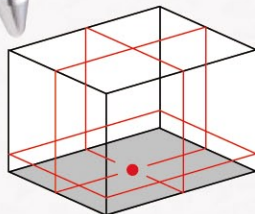

Laser line (P-440EX)



RE-20IP

RC-2

► SPECIFICATIONS (P-440EX)

Laser source	: Visible red laser diode
Wavelength	: 635nm (line) 650nm (down point)
Output power	: Maximum 4.5mW (class 2M)
Width of laser line	: within 1.5mm / 5m
Fan angle (for vertical)	: More than 90°
Fan angle (for horizontal)	: approx. 110°
Diameter of down point	: approx. 1.5mm ϕ / 1m
Accuracy	
Vertical & horizontal line	: ± 1 mm / 10m
Down point	: ± 0.5 mm / 1m
Upper cross point	: ± 1 mm / 5m
Right angle	: ± 1 mm / 3m
Circular level	: 60' / 2mm
Mechanism	: X / Y 2-axis electronic leveling system
Self leveling range	: $\pm 2.0^\circ$
Rotating system	: 360° endless drive by adjusting screw
Operating temperature	: -10 ~ + 40°C
Operating range	: 10m or 20m with detector
Water & dust resistance	: IP 54
Power	: AC adapter / AA alkaline battery x 4
Operating time (all lines)	: approx. 3 hours
IEC laser class for safe	: Class 2M
Dimensions	: approx. 152 x 148 x H223mm
Weight (without batteries)	: approx. 1,650g



► STANDARD ACCESSORIES

- Hard carrying case
- AC adapter
- Alkaline batteries

► SPECIFICATIONS (DETECTOR RE-20IP)

Detecting instruction	: High luminance LED and buzzer
Detector accuracy	: ± 1 mm from the center of laser
Operating distance	: 1 ~ 20m
Operating temperature	: -10 ~ + 50 °C
Power	: 9V alkaline battery x 1
Dimensions	: H165mm x W55mm x D26.5mm
Weight	: approx. 150g (incl. battery)
IP	: IP 56

* Detector & rod clamp are optional accessories.

✓ CHECK

AUTOMATIC SELF-LEVELING

P-440EX is 4V4H full-automatic leveling system with IP54 structure. Impervious to vibration by the system is good to the construction sites. The sophisticated 2 axis electric motor for self-leveling and the parts shaped accurately by CNC lathe bring ± 1 mm per 10m accuracy. Using 15mW laser modules brings the brightest red laser line in class 2M laser in Myzox line up. Even under the strong sunshine, RE-20IP detector with IP56 catches the laser line precisely.



✓ CHECK

SPLASH-PROOF

P-440EX is IP54, but it provides better performance than the existing model. All parts hand in the air and not to attach the bottom as pictured in the figure. Even if the water enter into the instrument, this structure prevents from trouble such as shorting out.

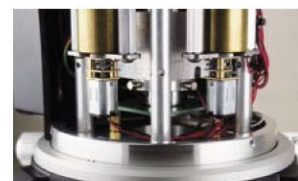

PRODUCT NAME	MODEL	PKG QTY	MOQ	CODE NO.	C/O
Electronic Automatic Line Laser / 4V4H	P-440EX	4	4	220400	TW
Detector with Clamp	RE-20IP/RC-2	1	4	216255	CN

TRIPOD 1
PRISM 2
POLE 3
STAFF 4
GNSS ACCESSORY 5
SURVEYING / LASER INSTRUMENT 6
SURVEYING ACCESSORY 7
MEASURING TOOL 8
TESTING INSTRUMENT 9
SECURITY GOODS 10

Elevating Tripod for Laser

LET series

FAVORITE HEIGHT

LET series brings you your favorite height.



✓ CHECK

DOUBLE QUICK LOCK

LET series has double quick lock at each legs. Quick setting and easy adjusting by quick lock leg.



► SPECIFICATIONS

Model	LET-B	LET-C	LET-S
Full extended	1,705mm	1,370mm	1,245mm
Full closed	605mm	525mm	410mm
Weight	1.34kg	2.42kg	0.61kg
Elevating range	305mm	240mm	245mm
Screw size	5/8inch	5/8inch	5/8inch

► REMARKS

- LET-B : Standard type
- LET-C : Robust type
- LET-S : Compact size

PRODUCT NAME	MODEL	PKG QTY	MOQ	CODE NO.	C/O
Tripod for Laser / Standard type	LET-B	6	6	213092	CN
Tripod for Laser / Robust type	LET-C	6	6	213696	CN
Tripod for Laser / Compact type	LET-S	8	8	215950	CN



Product Link

Line Laser Detectors

DETECTORS



USEFUL IN BRIGHT LIGHT

Detector finds the unclear line in bright light.

► FEATURES

- Auto power off

► SPECIFICATIONS

Sign	: LED & buzzer
Accuracy	: ±1mm
Operating temperature	: -10 ~ + 50°C
Operating range	: 1 ~ 20m
Battery	: 9V block battery

COMPATIBILITY TABLE

Model	G-440S	G-410S	G-210S	G-110S	P-440EX
GL-RE4		✓			
GL-RES	✓		✓	✓	
RE-20IP					✓
TL-RE					✓

Model	P-410EX	P-210EX	P-110EX
GL-RE4			
GL-RES			
RE-20IP	✓	✓	✓
TL-RE	✓	✓	✓

PRODUCT NAME	MODEL	PKG QTY	MOQ	CODE NO.	C/O
Detector for G-410S	GL-RE4	1	8	220910	CN
Detector for G-S series	GL-RES	1	8	221443	CN
Clamp for G-410S/G-S series	GL-RC	1	8	219849	CN
Detector for Red Laser	RE-20IP	1	8	217834	CN
Clamp for RE-20IP	RC-2	1	8	217835	CN
Detector for Red Laser	TL-RE	1	8	217837	CN
Clamp for TL-RE	TL-RC	1	8	217838	CN

Automatic Rotating Laser

MJ-300 series

AUTO-LEVELING ROTATING LASER

Wide-range, 600m, automatic-leveling rotating laser.



MJ-300

► SPECIFICATIONS (MJ-300)

Laser source	: Visible red laser diode
Wavelength	: 635nm (line)
Output power	: 1.0 ~ 2.0mW
Laser class	: Class 3R
Measuring range	: 0.5 ~ 300m (radius)
Accuracy	: ± 15" (± 0.75mm / 10m)
Self leveling range	: ± 3.5°
Automatic leveling time	: approx. 30"
Operating temperature	: -10 ~ + 45°C
Rotating speed	: 600rpm
Operating time	: 20 hours
Water & dust resistance	: IP 54
Power	: C alkaline batteries x 4
Dimensions	: approx. 205 x 155 x 205mm
Weight (without batteries)	: approx. 1,850g

► STANDARD ACCESSORIES

- Hard carrying case
- Manual
- C alkaline batteries x 4
- Detector with clamp
(MJ-300S) D-RE / D-RC
(MJ-300) MJ-RE2 / MJ-RC2 x 2 set

Digital Laser Detector D-RE set

MJ-300S
Digital readout



D-RE



D-RC



The readout is displayed on the large front and rear displays and shows exactly how far the elevation is from on-grade.

► SPECIFICATIONS (DETECTOR D-RE)

Detective width	: 90mm (-30 ~ 60mm)
Numeric readout height	: 80mm (-25 ~ 55mm)
Detective angle	: ± 45°
Detective wavelength	: 450~800nm
Accuracy	: ± 1.0 / ± 2.0 / ± 5.0 / ± 10.0mm
Power	: AA alkaline battery x 1
Auto power off	: 30 minutes from no operation
Dimensions	: 135 x 69 x 25mm
Weight	: approx.175g (excl. battery)
Dust & waterproof	: IP67

Detector MJ-RE2 x 2 set

MJ-300
Work efficiently with 2 detectors



MJ-RE2

MJ-RC2

▲▼ (allows) shows whether the laser beam hits higher or lower than the center line.

► SPECIFICATIONS (DETECTOR MJ-RE2)

Detective width	: 48mm (-24 ~ 24mm)
Detective wavelength	: 635nm
Accuracy	: ± 1.0 / ± 2.5mm
Power	: 9V alkaline battery x 1
Auto power off	: 7 minutes from no operation
Dimensions	: 136 x 65 x 25mm
Weight	: approx.170g (excl. battery)

✓ CHECK

AUTO-LEVELING ROTATING LASER

This is good for wide-range usage in 600m diameter horizontally with the equipped detector.

Stable rotation and laser keeps high accuracy at 15" (0.75mm/10m).

It has compact body and light weight, but it is sophisticated and tough.

Also, body structure is designed as IP54, and is unaffected by a weather situation at working fields.

Setting on tripod is very easy, just to mount the laser to tripod and screw the locking handle.



PRODUCT NAME	MODEL	PKG QTY	MOQ	CODE NO.	C/O
Automatic Rotating Laser / D-RE set	MJ-300S	1	4	221957	CN/DE
Digital Laser Detector with Clamp	D-RE/D-RC	1	4	221958	DE
Digital Laser Detector	D-RE	1	4	221959	DE
Clamp for D-RE	D-RC	1	4	221960	DE
Automatic Rotating Laser / MJ-RE2 x 2 set	MJ-300	1	4	219853	CN
Detector with Clamp	MJ-RE2/MJ-RC2	1	4	220158	CN
Detector	MJ-RE2	1	4	21787201	CN
Clamp for MJ-RE2	MJ-RC2	1	4	21787301	CN

TRIPOD 1
PRISM 2
POLE 3
STAFF 4
GNSS ACCESSORY 5
SURVEYING / LASER INSTRUMENT 6
SURVEYING ACCESSORY 7
MEASURING TOOL 8
TESTING INSTRUMENT 9
SECURITY GOODS 10

Elevating Tripod

NEL-33SL (NEL series)



NEL-33SL

HIGH DUST-PROOFNESS

NEL-33SL keeps smooth elevating by preventing the inflow of sand.

► FEATURES



Tripod head cover



Safety chain



Wide space



Adjustable level



Black alumite

► SPECIFICATIONS

Full extended	: 1,735mm
Full closed	: 1,030mm
Elevating range	: 335mm
Tripod head	: 148mm φ
Leg type	: Short leg
Weight	: 6.2kg



Product Link

PRODUCT NAME	MODEL	PKG QTY	MOQ	CODE NO.	C/O
Tripod / Dustproof / Orange / Flat	NEL-33SL	1	10	217487	CN

Elevating Tripod (Tall-type)

KEL-300

HIGH PLACE WORKING

It is the tallest model in Myzox product lineup.



► SPECIFICATIONS

Full extended	: 3,010mm
Full closed	: 1,260mm
Weight	: 6.8kg
Tripod head size	: 148mm φ
Elevating range sec.1	: 540mm
Elevating range sec.2	: 530mm



Product Link

PRODUCT NAME	MODEL	PKG QTY	MOQ	CODE NO.	C/O
Tripod / Orange / Flat	KEL-300	1	5	217425	CN

Scale Staff

MTR series



MTR-22

MTR-33

WITH DETECTORS

It's best for using with laser detectors.



► SPECIFICATIONS

Model	MTR-22	MTR-33
Graduation	Metric	Metric
Section	2m / 2sec	3m / 3sec
Full closed	1,120mm	1,140mm
Weight	0.50kg	0.80kg

PRODUCT NAME	MODEL	PKG QTY	MOQ	CODE NO.	C/O
Scale Staff 2m/2sec.	MTR-22	5	5	011036	TW
Scale Staff 3m/3sec.	MTR-33	5	5	011037	TW

Wall Mount

WALL MOUNT

GOOD FOR CEILING WORK

When setting the height of ceiling, this is very useful.



KTM (for Line Laser)



WMT (for Rotating Laser)

► SPECIFICATIONS

MODEL	KTM	WMT
Screw size	5/8 inch	5/8 inch
Weight	450g	940g
Dimensions	250 x 101 x 134mm	320 x 80 x 190mm

PRODUCT NAME	MODEL	PKG QTY	MOQ	CODE NO.	C/O
Wall Mount for Line Laser	KTM	1	10	213058	CN
Wall Mount for Rotating Laser	WMT	1	10	219307	CN

Leveling Adapter

RL-TB

FINE ADJUSTING

After setting the tripod, laser can be leveled.



► SPECIFICATIONS

Screw size (upper)	: 5/8 inch thread
Screw size (bottom)	: 5/8 inch hole
Dimensions	: H56mm x 74mm φ
Weight	: 450g

PRODUCT NAME	MODEL	PKG QTY	MOQ	CODE NO.	C/O
Leveling Adapter	RL-TB	1	5	213010	CN



SURVEYING ACCESSORY

- Backpack for Total Station P094
- Surveying Nail & Marker P095
- Plane Table P097
- Plumb bob / Stereoscope / Pocket Compass P098
- Clinometer / Compass P099
- Surveying Peg P100
- Survey Bag / Hand Level P101
- Field Book / Binocular / Marking Template P102
- Vertex Laser / Surveying Umbrella / Lightning Detector P103
- Ground Control Point / Anemometer P104



TRIPOD	1
PRISM	2
POLE	3
STAFF	4
GNSS ACCESSORY	5
SURVEYING / LASER INSTRUMENT	6
SURVEYING ACCESSORY	7
MEASURING TOOL	8
TESTING INSTRUMENT	9
SECURITY GOODS	10

NEW Backpack for Total Station M-RBP series

LIGHTNESS & STABILITY

M-RBP series have developed to carry a burden safely and lightly.



M-RBP2



M-RBPS



► FEATURES

- Almost all instruments can be stored
- Suspension system by waist belt
- Hands free by backpack style
- High capacity & pockets

► SPECIFICATIONS

Model	M-RBP2	M-RBPS
Dimensions	400 x 350 x 650mm	300 x 300 x 500mm
Weight	approx. 3.5kg	approx. 2.5kg

✓ CHECK

Common Features



Flap



Reflector



Water-shedding fabric



Double Belts



High Cushioning
Fixed 6 + Removable 6



Side Pockets
*No cushion

M-RBP2

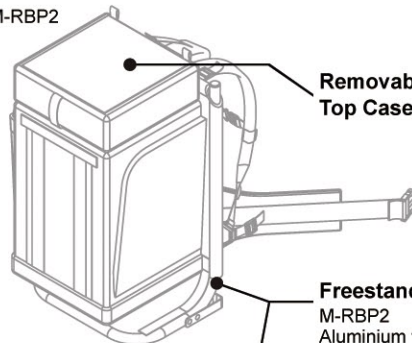

Removable Top Case

Freestanding M-RBP2 Aluminium frame

M-RBPS

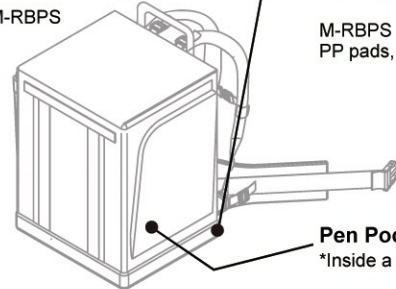

M-RBPS PP pads, no frame

Pen Pocket
*Inside a side pocket



✓ CHECK

Inner Dimension *Dimension is rough estimate
(both M-RBP2 and M-RBPS) *() is added cushioning properties



Cushions

with Cushions

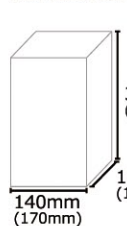

140mm (170mm)

without Cushions



200mm (230mm)

330mm (350mm)

150mm (170mm)

400mm (420mm)

220mm (240mm)

+1 OPTION



Water-resistant Rain Cover RBP-WP

- for M-RBP2
- Drawstring
 - Waterproof tape



PRODUCT NAME	MODEL	PKG QTY	MOQ	CODE NO.	C/O
Backpack for Total Station - Regular	M-RBP2	1	1	221825	CN
Backpack for Total Station - Compact	M-RBPS	1	1	221510	CN
Water-resistant Rain Cover	RBP-WP	1	1	221499	CN



Product Link

Surveying Nail & Marker

KONOE NAIL & MARKER

BETTER BEND THAN BREAK

KONOE nail is bent before breaking to avoid injury.

for CONCRETE

NO.01  L : 27mm / 2g

NO.1  L : 43mm / 6g

for ASPHALT

NO.2  L : 55mm / 20g

NO.R  L : 65mm / 25g

NO.3  L : 80mm / 30g

for GRAVEL

NO.4S  L : 55mm / 32g

NO.4  L : 105mm / 50g

NO.5  L : 130mm / 65g

NO.7  L : 205mm / 100g

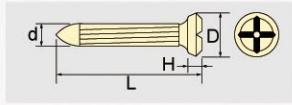

► NAIL

PRODUCT NAME	MODEL	PKG QTY	MOQ	CODE NO.	C/O
Nail / D6 x d4 x L27 x H2 / 100pcs	NO.01	10	10	122026	JP
Nail / D9 x d5 x L43 x H3 / 100pcs	NO.1	5	5	122027	JP
Nail / D15 x d7 x L55 x H5 / 100pcs	NO.2	1	1	122028	JP
Nail / D15 x d7 x L65 x H4 / 100pcs	NO.R	1	1	122029	JP
Nail / D15 x d7 x L80 x H5 / 100pcs	NO.3	1	1	122030	JP
Nail / D20 x d9 x L25 x H5 / 50pcs	NO.4S	1	1	213830	JP
Nail / D20 x d9 x L105 x H5 / 50pcs	NO.4	1	1	122031	JP
Nail / D20 x d9 x L130 x H5 / 50pcs	NO.5	1	1	122032	JP
Nail / D20 x d9 x L205 x H5 / 50pcs	NO.7	1	1	122033	JP

Surveying Nail & Marker

MEASURE NAIL & MARKER

EASY TO NAIL AND HARD TO UNNAIL

It is a moment to drive the nail, but it remains semipermanently.

for CONCRETE

NO.01  L : 25mm / 2g

NO.1  L : 40mm / 5g

for ASPHALT

NO.2  L : 50mm / 18g

NO.R  L : 60mm / 24g

NO.3  L : 75mm / 28g

for GRAVEL

NO.4  L : 100mm / 55g

NO.5  L : 125mm / 65g

NO.7  L : 200mm / 100g

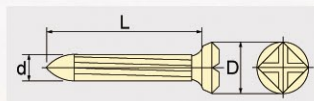

► NAIL

PRODUCT NAME	MODEL	PKG QTY	MOQ	CODE NO.	C/O
Nail / D6 x d4 x L25 / 100pcs	NO.01	10	10	122054	JP
Nail / D9 x d5 x L40 / 100pcs	NO.1	5	5	122055	JP
Nail / D15 x d7 x L50 / 100pcs	NO.2	1	1	122056	JP
Nail / D15 x d7 x L60 / 100pcs	NO.R	1	1	122057	JP
Nail / D15 x d7 x L75 / 100pcs	NO.3	1	1	122058	JP
Nail / D20 x d8 x L100 / 50pcs	NO.4	1	1	122059	JP
Nail / D20 x d8 x L125 / 50pcs	NO.5	1	1	122060	JP
Nail / D20 x d8 x L200 / 50pcs	NO.7	1	1	122061	JP



► COMPARABILITY TABLE

NAIL	MARKER
NO.01 / NO.1	W204 / W201 / W203 / W209 / W206
NO.2 / NO.R / NO.3 / NO.4S NO.4 / NO.5 / NO.7	W304 / W301 / W303 / W315 / W309 / W306

► MARKER

PRODUCT NAME	MODEL	PKG QTY	MOQ	CODE NO.	C/O
Marker / D27 x d5 x H4 / 100pcs	W204/B	10	10	122035	JP
Marker / D27 x d5 x H4 / 100pcs	W201/R	10	10	122036	JP
Marker / D27 x d5 x H4 / 100pcs	W203/Y	10	10	122037	JP
Marker / D27 x d5 x H4 / 100pcs	W209/W	10	10	122041	JP
Marker / D27 x d5 x H4 / 100pcs	W206/G	10	10	212124	JP
Marker / D47 x d10 x H7 / 20pcs	W304/B	50	50	122038	JP
Marker / D47 x d10 x H7 / 20pcs	W301/R	50	50	122039	JP
Marker / D47 x d10 x H7 / 20pcs	W303/Y	50	50	122040	JP
Marker / D47 x d10 x H7 / 20pcs	W315/W	50	50	122042	JP
Marker / D47 x d10 x H7 / 20pcs	W309/W	50	50	215945	JP
Marker / D47 x d10 x H7 / 20pcs	W306/G	50	50	212125	JP

Surveying Nail & Marker

MEASURE NAIL & MARKER

EASY TO NAIL AND HARD TO UNNAIL

It is a moment to drive the nail, but it remains semipermanently.

for CONCRETE

NO.01  L : 25mm / 2g

NO.1  L : 40mm / 5g

for ASPHALT

NO.2  L : 50mm / 18g

NO.R  L : 60mm / 24g

NO.3  L : 75mm / 28g

for GRAVEL

NO.4  L : 100mm / 55g

NO.5  L : 125mm / 65g

NO.7  L : 200mm / 100g

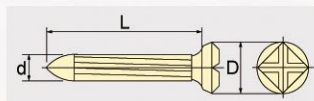

► COMPARABILITY TABLE

NAIL	MARKER
NO.01 / NO.1	NO.2
NO.2 / NO.R / NO.3 / NO.4S NO.4 / NO.5 / NO.7	NO.3

► MARKER

PRODUCT NAME	MODEL	PKG QTY	MOQ	CODE NO.	C/O
Marker / D25 x d5 x H4 / 100pcs	NO.2/B	5	5	122074	CN
Marker / D25 x d5 x H4 / 100pcs	NO.2/R	5	5	122075	CN
Marker / D25 x d5 x H4 / 100pcs	NO.2/Y	5	5	122076	CN
Marker / D25 x d5 x H4 / 100pcs	NO.2/W	5	5	122004	CN
Marker / D25 x d5 x H4 / 100pcs	NO.2/G	5	5	210010	CN
Marker / D45 x d10 x H7 / 20pcs	NO.3/B	5	5	122077	CN
Marker / D45 x d10 x H7 / 20pcs	NO.3/R	5	5	122078	CN
Marker / D45 x d10 x H7 / 20pcs	NO.3/Y	5	5	122079	CN
Marker / D45 x d10 x H7 / 20pcs	NO.3/W	5	5	122080	CN
Marker / D45 x d10 x H7 / 20pcs	NO.3/G	5	5	210011	CN

Surveying Nail & Marker

EARTH NAIL & MARKER

STRONG SPECIAL NAIL

Nail is bended for granted, it might be just superstition.

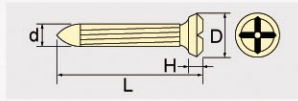

for CONCRETE

NO.01 L : 27mm / 2g

NO.1 L : 43mm / 5g

for ASPHALT

NO.2 L : 55mm / 20g

NO.3 L : 80mm / 30g

for GRAVEL

NO.4 L : 105mm / 50g

NO.5 L : 130mm / 65g

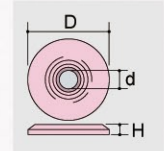

COMPARABILITY TABLE

NAIL		MARKER
NO.01 / NO.1		NO.2
NO.2 / NO.3 / NO.4 / NO.5		NO.3

MARKER

PRODUCT NAME	MODEL	PKG QTY	MOQ	CODE NO.	C/O
Marker / D27 x d5 x H4 / 100pcs	NO.2/R	5	5	212161	JP
Marker / D27 x d5 x H4 / 100pcs	NO.2/B	5	5	212162	JP
Marker / D27 x d5 x H4 / 100pcs	NO.2/Y	5	5	212163	JP
Marker / D27 x d5 x H4 / 100pcs	NO.2/W	5	5	212164	JP
Marker / D47 x d10 x H10 / 20pcs	NO.3/R	5	5	212165	JP
Marker / D47 x d10 x H10 / 20pcs	NO.3/B	5	5	212166	JP
Marker / D47 x d10 x H10 / 20pcs	NO.3/Y	5	5	212167	JP
Marker / D47 x d10 x H10 / 20pcs	NO.3/W	5	5	212168	JP

NAIL

PRODUCT NAME	MODEL	PKG QTY	MOQ	CODE NO.	C/O
Nail / D6 x d4 x L27 x H2 / 100pcs	NO.01	10	10	212141	JP
Nail / D9 x d5 x L43 x H3 / 100pcs	NO.1	5	5	212142	JP
Nail / D15 x d7 x L55 x H5 / 100pcs	NO.2	1	1	212143	JP
Nail / D15 x d7 x L80 x H5 / 100pcs	NO.3	1	1	212144	JP
Nail / D20 x d9 x L105 x H5 / 50pcs	NO.4	1	1	212145	JP
Nail / D20 x d9 x L130 x H5 / 50pcs	NO.5	1	1	212146	JP

Surveying Nail & Marker

ALUMINIUM MARKER

EXTRA TOUGH

Aluminium brings extra toughness.



AC30

AC40B
(Big hole)

AC40S
(Small hole)



AC50

AC60

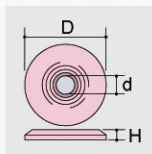

SPECIFICATIONS

Model	AC30	AC40B	AC40S
Size (mm)	D30 x d5 x H6	D40 x d8 x H6	D40 x d5 x H6
Model	AC50	AC60	
Size (mm)	D50 x d8 x H6	D60 x d10 x H9	

PRODUCT NAME	MODEL	PKG QTY	MOQ	CODE NO.	C/O
Aluminium Marker / D30 x d5 x H6	AC30	-	20	210005	JP
Aluminium Marker / D40 x d8 x H6	AC40B	-	20	210006	JP
Aluminium Marker / D40 x d5 x H6	AC40S	-	20	122472	JP
Aluminium Marker / D50 x d8 x H6	AC50	-	20	122471	JP
Aluminium Marker / D60 x d10 x H9	AC60	-	20	122470	JP

Surveying Nail

ANCHOR NAIL

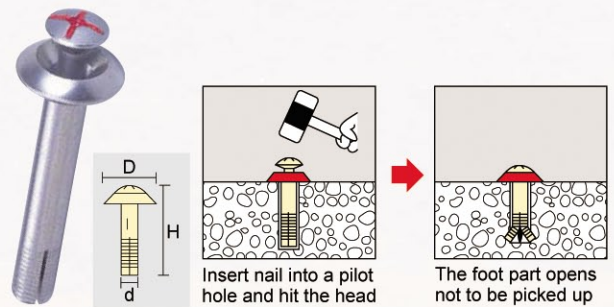

PRODUCT NAME	MODEL	PKG QTY	MOQ	CODE NO.	C/O
Anchor Nail / D20 x d8 x H50 / 50pcs	AN	-	1	122348	JP

Surveying Nail

MARKING NAIL

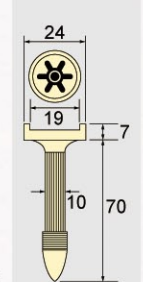

SPECIFICATIONS

Weight : 50g

PRODUCT NAME	MODEL	PKG QTY	MOQ	CODE NO.	C/O
Marking Nail / 50pcs	KONOE BM	-	1	122044	JP

Plane Table Set

PLANE TABLE SET

SPEAKING OF MAKING MAP

Everybody can make a map easily with these equipments.



► PLANE TABLE SET (Plane table & tripod with moving head)



► METAL ALIDADE SET
 • Metal alidade (22cm)
 • Plumbing arm small (255mm)
 • Aluminium scale (1/1000 & 1/500)
 • Degrinatoire
 • Plumb bob (brass made)
 • Cord adjuster

► SPECIFICATIONS

Model	YHB-26S	TPT-M	MAS-22
Size	Closed: 960mm Extended: 1,650mm	500 x 410 x 26mm	390 x 170 x 50mm
Weight	4.8kg	2.3kg	1.0kg

PRODUCT NAME	MODEL	PKG QTY	MOQ	CODE NO.	C/O
Plane Table Set	YHB-26S	1	1	220401	JP
Plane Table	TPT-M	1	1	102403	JP
Metal Alidade Set	MAS-22	1	1	061008	JP

Plumbing Arm

PLB

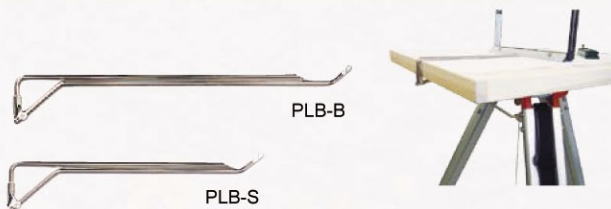

► SPECIFICATIONS

Model	PLB-S	PLB-B
Size	255mm	355mm

PRODUCT NAME	MODEL	PKG QTY	MOQ	CODE NO.	C/O
Plumbing Arm / 255mm	PLB-S	-	5	101808	JP
Plumbing Arm / 355mm	PLB-B	-	5	101807	JP

Degrinatoire

DGT



► REMARKS
 • It can be screwed to the table

PRODUCT NAME	MODEL	PKG QTY	MOQ	CODE NO.	C/O
Degrinatoire	DGT	-	5	061012	JP

Measuring Probe for Plane Table

PTMP



PRODUCT NAME	MODEL	PKG QTY	MOQ	CODE NO.	C/O
Measuring Probe / Single	PTMB-S	-	5	102347	JP
Measuring Probe / Double	PT-MB-D	-	5	102346	JP

Optical Square

OS-DD



► FEATURES
 • Double pentaprism

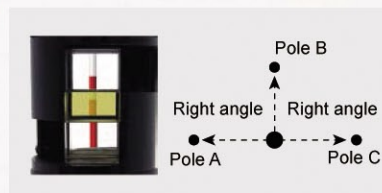

PRODUCT NAME	MODEL	PKG QTY	MOQ	CODE NO.	C/O
Optical Square	OS-DD	1	10	102522	CN

TRIPOD 1
 PRISM 2
 POLE 3
 STAFF 4
 GNSS ACCESSORY 5
 SURVEYING / LASER INSTRUMENT 6
 SURVEYING ACCESSORY 7
 MEASURING TOOL 8
 TESTING INSTRUMENT 9
 SECURITY GOODS 10

Brass Made Plumb Bob

PB series

VARIOUS WEIGHTS

You can choose favorite weight to suit the condition.



70g



230g



300g

SPECIFICATIONS

Model	PB70	PB230	PB300
Weight	70g	230g	300g

REMARKS

- Steel tip (PB230 / PB300)

PRODUCT NAME	MODEL	PKG QTY	MOQ	CODE NO.	C/O
Plumb Bob / 70g	PB70	1	10	102221	CN
Plumb Bob / 230g	PB230	1	10	102223	CN
Plumb Bob / 300g	PB300	1	10	102228	JP

Pocket Stereoscope

E-2X / E-4X



Adjustable interpupillary distance

REMARKS

- 2X magnification (E-2X)
- 4X magnification (E-4X)

PRODUCT NAME	MODEL	PKG QTY	MOQ	CODE NO.	C/O
Pocket Stereoscope / 2X	E-2X	1	2	122920	JP
Pocket Stereoscope / 4X	E-4X	1	2	122921	JP

Tubular Level for Plane Table

ED-CHB



Luminous

SPECIFICATIONS

Sensitivity : 46"/2mm

PRODUCT NAME	MODEL	PKG QTY	MOQ	CODE NO.	C/O
Tubular Level for Plane Table	ED-CHB	-	6	-	JP

Pocket Compass

S series

HANDY AND COMPACT

This is used for mountain, forest and land surveying work.



S-25



S-28



SPECIFICATIONS (POCKET COMPASS)

- Telescope : Reversible, erect, 12X, 120mm Long
- Tubular level : 5' / 2mm
- Horizontal circle : 5', "O-BAC" zero setting
- Compass circle : Diameter=70mm, Minimum reading : 1°
- Vertical circle : Full circle, Minimum reading : 1°

Model	LS-25	S-25	S-27	S-28
Telescope	✓	✓	✓	No Reversible
Tubular level	✓	✓	✓	✓
Horizontal circle	✓	✓	✓	✓
Compass circle	✓	✓	✓	✓
Vertical circle	✓	✓	✓	Semi-circle
Weight	1.1kg	1.0kg	0.9kg	0.9kg

SPECIFICATIONS (No.33)

- Material : Duralumin
- Extended length : 132cm
- Closed length : 53cm
- Weight : 0.9kg



Optional tripod

PRODUCT NAME	MODEL	PKG QTY	MOQ	CODE NO.	C/O
Pocket Compass	LS-25	1	1	082607	JP
Pocket Compass	S-25	1	1	082603	JP
Pocket Compass	S-27	1	1	082604	JP
Pocket Compass	S-28	1	1	082605	JP
Tripod for Pocket Compass	No.33	1	1	041063	JP

Clinometer

CLINOMETER

GEOLOGICAL SURVEY NECESSITY

Clinometer let you know the strike or dip on the plane of stratification or fault.



CLM



With mirror(CLMM)



Back(CLMM)

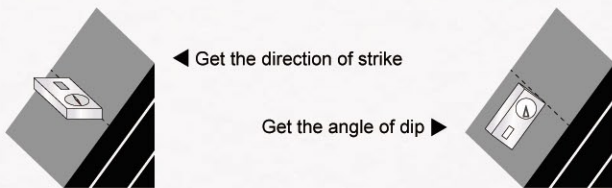

SPECIFICATIONS

Model	CLM	CLMM
Size	108 x 60 x 12mm	108 x 60 x 12mm
Weight	210g	220g

PRODUCT NAME	MODEL	PKG QTY	MOQ	CODE NO.	C/O
Clinometer	CLM	1	1	102553	JP
Clinometer with Mirror	CLMM	1	1	219593	JP

Brunton type Compass

BTC

MADE IN JAPAN

This is quite popular model all over the world.



FEATURES

- For surface or underground preliminary surveying, topographical and geological field work
- High reliability by Japan made
- Durable die-cast aluminium body; precision-aligned mirror with "see-through" sighting

SPECIFICATIONS

Needle : 55mm damped needle
 Graduation : Horizontal : 360° Vertical : 90° w/ vernier scale,
 Slope (%)

PRODUCT NAME	MODEL	PKG QTY	MOQ	CODE NO.	C/O
Brunton type Compass	BTC	1	1	102531	JP

Compass with LED

LED Compass

INDICATE IN THE DARK

Red LED light indicates the azimuth in the dark.



FEATURES

- Red LED light (PAT.P)
- Brightly colored
- Oil compass

SPECIFICATIONS

Size : 88 x 54 x 14mm
 Weight : 30g
 Resolution : 2°
 Power : CR2016 x 1
 Battery life : approx. 20h

PRODUCT NAME	MODEL	PKG QTY	MOQ	CODE NO.	C/O
LED Compass / Green	43023-9	10	10	220546	CN
LED Compass / Blue	43024-6	10	10	220547	CN

Compass

COMPASSES

YOUR NAVIGATOR

For your purpose, you can choose the suitable one.



SPECIFICATIONS

Model	NO.910	NO.825	NO.162
Dimension	45mm φ	45mm φ	100 x 55 x 11mm
Weight	23g	37g	34g

REMARKS

- Oil damper system (NO.910 / NO.825)
- Thermometer and magnifier included (NO.162)

PRODUCT NAME	MODEL	PKG QTY	MOQ	CODE NO.	C/O
Compass	NO.910	1	10	082422	JP
Compass	NO.825	1	10	082413	JP
Compass	NO.162	1	10	221016	JP

Compass Eyeglass type

COMPASSGLASS

JUST PEERING

To get the direction, it's just looking into COMPASSGLASS.

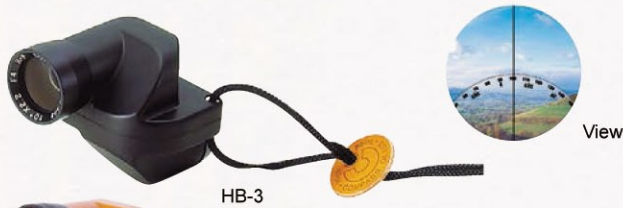

HB-3



HB-3L

► FEATURES

- Easy to read by large compass
- Readable graduation without light
- High and stable performance even at altitude 10,000m
- Workable even at 50m depth in water
- Focus-free

► SPECIFICATIONS

Model	HB-3	HB-3L
Field of view	10°	10°
Magnification	2.2X	2.2X
Weight	78g	78g
Size	80 x 58 x 53mm	80 x 58 x 53mm
Resolution	360°(Min.1°), 16 azimuth	360°(Min.1°), 16 azimuth
Led light	-	YES

PRODUCT NAME	MODEL	PKG QTY	MOQ	CODE NO.	C/O
Compassglass / Black	HB-3BL	1	1	219253	JP
Compassglass / Orange	HB-3OR	1	1	220283	JP
Compassglass / Black / LED	HB-3LBL	1	1	219254	JP
Compassglass / Orange / LED	HB-3LOR	1	1	220284	JP

Compass

SILVA COMPASS

SUPERIOR ACCURACY

SILVA compass is simple design, but it has multiple functions for various purposes.



EXPEDITION S

RANGER

► SPECIFICATIONS

Model	EXPEDITION S	RANGER
Attachment	Detachable safety-release scale lanyard	Detachable safety-release scale lanyard
Clinometer	Yes	No
Declination adjustment	Permanent adjustment for local magnetic declination	Declination scale inside capsule
Illumination	Luminous markings	Luminous markings
Magnifying lens	Yes	Yes
Scales	1:25k, 1:50k, GPS scales, lanyard; 1:25, / 1:50, mm, inch	1:25k, 1:50k, lanyard; 1:25, / 1:50, mm, inch
Sighting system	Mirror sighting with sighting hole	-
Silicon friction feet	Yes	No
Weight	86g	33g
Variant	Magnetic equator, Magnetic south, Magnetic north	Magnetic equator, Magnetic south, Magnetic north
Slope card	Yes	No

PRODUCT NAME	MODEL	PKG QTY	MOQ	CODE NO.	C/O
SILVA Compass	EXPEDITION S	1	5	219249	CN
SILVA Compass	RANGER	1	5	221458	CN

Plastic Surveying Peg

ETAPRON

LIGHT AND STRONG

This peg is of quite tough enough to drive with wooden hammer.

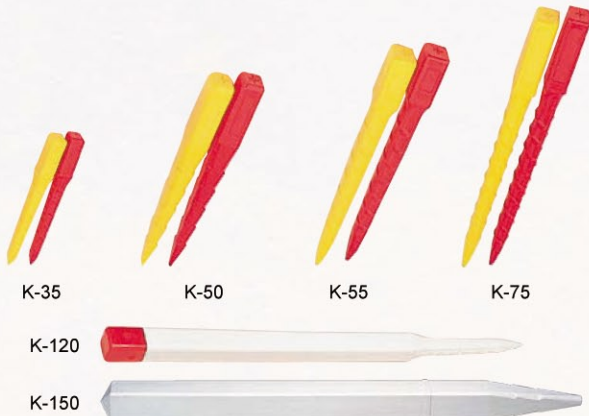

► SPECIFICATIONS

Model	K-35	K-50	K-55
Size	30 x 30 x 350mm	50 x 50 x 500mm	55 x 55 x 550mm

Model	K-75	K-120	K-150
Size	55 x 55 x 750mm	60 x 60 x 1,200mm	100 x 100 x 1,500mm

PRODUCT NAME	MODEL	PKG QTY	MOQ	CODE NO.	C/O
Etapron / 350mm	K-35	200	200	123001	JP
Etapron / 500mm	K-50	50	50	123000	JP
Etapron / 550mm	K-55	50	50	123004	JP
Etapron / 750mm	K-75	50	50	123006	JP
Etapron / 1,200mm	K-120	20	20	123008	JP
Etapron / 1,500mm	K-150	6	6	211034	JP

Wooden Surveying Peg

KIGUI

SURVEYING MARKER

Your favorite color is selectable to find the point easily.

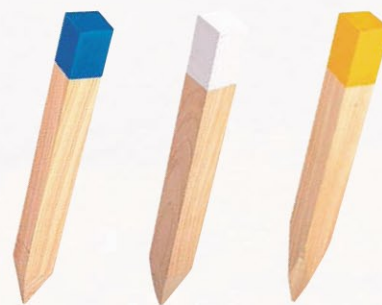

► COLOR



*If you need other sizes or colors, please ask us.

► SPECIFICATIONS

Model	W4560	W4590	W6045	W6060
Size	45 x 45 x 600mm	45 x 45 x 900mm	60 x 60 x 450mm	60 x 60 x 600mm

PRODUCT NAME	MODEL	PKG QTY	MOQ	CODE NO.	C/O
Kigui / 45 x 45 x 600mm	W4560	20	20	219586	JP
Kigui / 45 x 45 x 900mm	W4590	12	12	219587	JP
Kigui / 60 x 60 x 450mm	W6045	12	12	219588	JP
Kigui / 60 x 60 x 600mm	W6060	12	12	219589	JP

NEW **Bag for Piles**
PILE-SACK

SPECIALIZED FOR PILES
Large capacity, vertical putting piles.



- **FEATURES**
- Side fastener
 - 3 pockets for accessories
 - Storable 10 piles(70 x 70 x 600mm) / 20 piles(45 x 45 x 450mm)
- **SPECIFICATIONS**
- Material : Terylene
Dimensions: H580 x D160 x W350mm

PRODUCT NAME	MODEL	PKG QTY	MOQ	CODE NO.	C/O
Bag for Piles	PZET	1	1	212245	JP

NEW **Seamless Backpack**
ZAT

WATER RESISTANCE & WASHABLE
Washable inside and outside.



- **FEATURES**
- Roll-down closure
 - Detachable shoulder belt
- **SPECIFICATIONS**
- Material : PVC tarpaulin, Polypropylene, Polyacetal
Dimensions: H460 x D200 x W300mm
Weight : 900g

PRODUCT NAME	MODEL	PKG QTY	MOQ	CODE NO.	C/O
Seamless Backpack	G300-6409	1	1	221536	CN

NEW **Hand Level / Abney Level**
HAND LEVEL / ABNEY LEVEL

MADE IN JAPAN
This is simple product, so you can see the quality differences.

► **HAND LEVEL**



R55



Magnification: 5X

M80



► **HAND LEVEL**



40311



Magnification: 3.5X

40340



► **ABNEY LEVEL**



M70

Vernier scale, Slope (%), Magnification: 5X



► **ABNEY LEVEL**



40350

Vernier scale, Slope (%), Magnification: 3.5X



A65

Vernier scale, Slope (%)



40321

Vernier scale, Slope (%)



A54

Vernier scale, Slope (%)



40320

Vernier scale, Slope (%)



PRODUCT NAME	MODEL	PKG QTY	MOQ	CODE NO.	C/O
Hand Level / 132mm	R55	1	5	102511	JP
Hand Level / 200mm	M80	1	5	102512	JP
Abney Level / 195mm	M70	1	5	102516	JP
Abney Level / 172mm	A65	1	5	102514	JP
Abney Level / 133mm	A54	1	5	102513	JP

PRODUCT NAME	MODEL	PKG QTY	MOQ	CODE NO.	C/O
Hand Level / 130mm	40311	1	5	221417	JP
Hand Level / 200mm	40340	1	5	221421	JP
Abney Level / 180mm	40350	1	5	221420	JP
Abney Level / 180mm	40321	1	5	221419	JP
Abney Level / 130mm	40320	1	5	221418	JP

TRIPOD 1
PRISM 2
POLE 3
STAFF 4
GNSS ACCESSORY 5
SURVEYING / LASER INSTRUMENT 6
SURVEYING ACCESSORY 7
MEASURING TOOL 8
TESTING INSTRUMENT 9
SECURITY GOODS 10

Field Book

LEVEL BOOK

EASY-TO-USE

It's pocket size, quality paper, and big volume.



MZLB

✓ CHECK



Pocket Size



MZWP

✓ CHECK



Waterproof Paper (MZWP)

► FEATURES

- Made in Japan
- Write with standing up by hard cover (MZLB)
- Waterproof resin finish soft cover (MZWP)
- YUPO Paper (MZWP)

► SPECIFICATIONS

Model	MZLB	MZWP
Paper	Standard	Waterproof (YUPO)
Paper size	160 x 90mm	160 x 90mm
Quantity	40 sheets	24 sheets

PRODUCT NAME	MODEL	PKG QTY	MOQ	CODE NO.	C/O
Field Book	MZLB	10	10	218732	JP
Waterproof Field Book	MZWP	10	10	218733	JP

Binocular

OD

WORLD CLASS QUALITY

It is open hinge roof prism binoculars with waterproof.



► FEATURES

- Made in Japan
- Waterproof, dry nitrogen filled
- 3D rubber armored
- Roof prisms
- All lenses with fully multi coated optics
- Internal focus system
- Phase correction coated roof prisms
- Special mirror coated optics on prisms
- Twist up eyecups
- Diopter lock system
- Rainguard on oculars
- Close focus distance

► SPECIFICATIONS

Model	OD832	OD1032	OD842	OD1042
Lens	8 x 32	10 x 32	8 x 42	10 x 42
Real field of view	8°	6.4°	7°	6°

PRODUCT NAME	MODEL	PKG QTY	MOQ	CODE NO.	C/O
Binocular / 8 x 32	OD832	1	1	-	JP
Binocular / 10 x 32	OD1032	1	1	-	JP
Binocular / 8 x 42	OD842	1	1	-	JP
Binocular / 10 x 42	OD1042	1	1	-	JP

Stencil Plate

MABO

MARK YOUR MEASURING

Various sized templates mark your measuring history.

MBN



MB70



MB170



MB300

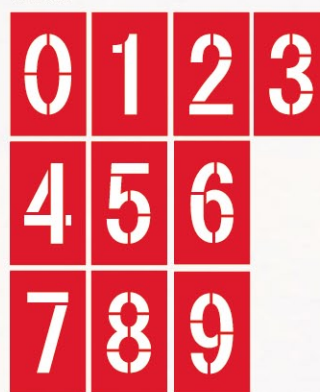

MB300N



MB45A



MB100



MB47M



MB117M



How to use

► REMARKS

- Plate size : 270 x 440mm
- Material : Polypropylene

PRODUCT NAME	MODEL	PKG QTY	MOQ	CODE NO.	C/O
Stencil Plate	MBN	-	10	219421	TW
Stencil Plate	MB45A	-	10	219422	TW
Stencil Plate	MB70	-	10	211442	TW
Stencil Plate	MB100	-	10	211443	TW
Stencil Plate	MB170	-	10	211444	TW

► SPECIFICATIONS

Model	MBN	MB45A	MB70
Character size	H: 25 / 45 / 70mm	H: 45mm	H: 70mm

Model	MB100	MB170	MB300
Character size	H: 100mm	H: 170mm	H: 300mm

Model	MB300N	MB47M	MB117M
Character size	H: 300mm	H: 45 / 70mm	H: 100 / 170mm

PRODUCT NAME	MODEL	PKG QTY	MOQ	CODE NO.	C/O
Stencil Plate	MB300	-	10	219424	TW
Stencil Plate	MB300N	-	10	219425	TW
Stencil Plate	MB47M	-	10	219427	TW
Stencil Plate	MB117M	-	10	219429	TW

Height Measuring Gauge

VERTEX IV

ACCURATE HEIGHT MEASURER

It is easy to measure the height easily by only yourself.



► FEATURES

- Easy to measure the height of standing objects, most often trees
- Easy operation
- Extreme small and light digital height measuring gauge

► SPECIFICATIONS

Model	VERTEX IV 360	VERTEX IV 60
Height	0 ~ 999m	0 ~ 999m
Height resolution	0.1m	0.1m
Angle	-55° ~ +85°	-55° ~ +85°
Angles deg / grad / %	Yes	Yes
Angle resolution	0.1°	0.1°
Power	AA battery	AA battery
Consumption	20mA	20mA
Dimensions	107 x 52 x 30mm	107 x 52 x 30mm
Weight	178g (with battery)	178g (with battery)
Measuring range	360°	60°

PRODUCT NAME	MODEL	PKG QTY	MOQ	CODE NO.	C/O
Vertex IV / 360°	VERTEX IV 360	1	1	216020	SW
Vertex IV / 60°	VERTEX IV 60	1	1	216021	SW

Surveying Umbrella

SU20

PROTECT FROM WEATHER

SU20 protects instruments and workers from direct sun and rain.



► SPECIFICATIONS
Size : 200cm

► STANDARD ACCESSORIES

- Umbrella
- Pole
- Peg for rope x 3
- Rope x 3
- Peg for pole



► FEATURES

- Good for using under the sun and rain



Under the sun



Under rain

PRODUCT NAME	MODEL	PKG QTY	MOQ	CODE NO.	C/O
Surveying Umbrella	SU20	2	10	219393	CN

NEW Lightning (Thunder) Detector

NTD-P01

DETECT APPROACH OF THUNDER

You can take immediate evacuation from thunder.

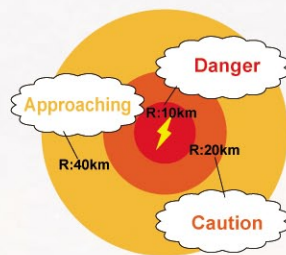

Approaching Caution Danger

► SPECIFICATIONS

- Detecting range : Max. 40km
- Operating time : approx. 400h
- Power : AAA battery x 2
- Size : 86 x 54.5 x 15.5mm
- Weight : approx. 65g

► FEATURES

- Easy to carry by compact body



PRODUCT NAME	MODEL	PKG QTY	MOQ	CODE NO.	C/O
Lightning Detector	NTD-P01	1	10	222004	JP

NEW Ground Control Point TH400 series

VISIBLE CLEARLY FROM ABOVE
Greatly increase the global accuracy of drone mapping.



TH400-BW

TH400-BY

TH400-BWR

CHECK



Matte coating

Matte coating restrains halation that might be caused by sunlight when photographed from above.

*Black and yellow: matte coating
White: matte material (no coating)

▶ FEATURES

- Center hole for a datum point
- Four fixing holes at the corners
- PP: hardly bend yet flexible

▶ SPECIFICATIONS

Size : 395 x 395 x 1mm
Holes : ϕ 10mm / 5 holes
Material : PP (polypropylene)
Weight : approx. 150g / 1sheet

PRODUCT NAME	MODEL	PKG QTY	MOQ	CODE NO.	C/O
Ground Control Point - Black / White	TH400-BW	10	1	221816	JP
Ground Control Point - Black / Yellow	TH400-BY	10	1	221817	JP
Ground Control Point - White circle / Black	TH400-BWR	10	1	222171	JP

NEW Ground Control Point PHOTOKLA

REVERSIBLE TYPE
Fixing nails included.



the surface

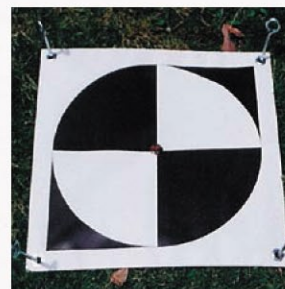

the back

▶ CONTENTS (THS)

- Ground control point x 20 sheets
- Fixing pin peg x 80
- Center nail x 20
- Hammer

▶ SPECIFICATIONS

Size : 395 x 395 x 1mm
Holes : ϕ 10mm / 5 holes
Material : PP (polypropylene)
Weight : approx. 150g / 1sheet



Center hole for nail

PRODUCT NAME	MODEL	PKG QTY	MOQ	CODE NO.	C/O
Ground Control Point Kit	THS	20	1	221530	JP
Ground Control Point / 20 sheets	TH	20	1	221531	JP

NEW Anemometer & Air Flow Meter SP-82AT

WIND SPEED, FLOWRATE AND TEMPERATURE
Pocket sized multi functional anemometer.



▶ FEATURES

- Display a maximum & minimum data
- Data hold function
- Right & compact

▶ SPECIFICATIONS

Measuring range
Wind speed : 0.4 ~ 20.0m/s
Flowrate : 0.024 ~ 36000CMM
Temperature : 0 ~ + 50°C
Resolution
Wind speed : 0.1m/s
Flowrate : 0.001 / 0.01 / 0.1 / 1CMM
Temperature : 0.1°C
Accuracy : \pm 3%F.S
Operating temperature : 0 ~ + 50°C, below 80%RH
Power : CR-2032 x 1
Dimensions : W45 x H120 x D20mm
Weight : approx. 160g

PRODUCT NAME	MODEL	PKG QTY	MOQ	CODE NO.	C/O
Anemometer & Air Flow Meter	SP-82AT	1	2	219770	TW

NEW Digital Anemometer DAM-30

WIND SPEED AND TEMPERATURE
Simple and rightest model with selected functions.



▶ FEATURES

- Display the beaufort scale
- Display a maximum & average data
- Data hold function
- Battery indicator
- Backlight
- Auto power off

▶ SPECIFICATIONS

Measuring range
Wind speed : 0 ~ 30.0m/s
Temperature : -10 ~ + 50°C
Resolution
Wind speed : 0.1m/s
Temperature : 0.1°C
Accuracy
Wind speed : \pm (5%rdg + 0.5m / s)
Temperature : \pm 2°C
Auto power off : 5 minutes
Power : AAA battery x 3
Dimensions : W54 x H163 x D30mm
Weight : approx. 120g

PRODUCT NAME	MODEL	PKG QTY	MOQ	CODE NO.	C/O
Anemometer	DAM-30	1	2	222323	CN



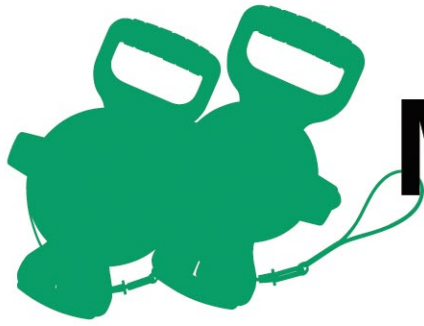

MEASURING TOOL



- Nylon Coated Steel Tape P106
- Fiberglass Tape P107
- Pocket Measuring Tape P108
- Non Conductive Measuring Tape / Pocket Rod / Measuring Tape P109
- Diameter Tape / Caliper P110
- Surveyor's Rope P111
- Measuring Wheel P112
- Chalk Liner P113
- Laser Rangefinder / Tally Counter P114
- Stopwatch / Curvimeter P115
- Planimeter P116
- Laser Plumb Bob P117
- Angle Level P118
- Spirit Level / Slant Rule P120
- Water Level Meter / Water Depth Meter P121
- Stream Gauge P122



TRIPOD	1
PRISM	2
POLE	3
STAFF	4
GNSS ACCESSORY	5
SURVEYING / LASER INSTRUMENT	6
SURVEYING ACCESSORY	7
MEASURING TOOL	8
TESTING INSTRUMENT	9
SECURITY GOODS	10

Nylon Coated Steel Tape 3X Fast Winding

MYS series

3X WINDING SPEED

Special gear mechanism can be wound 3x faster.

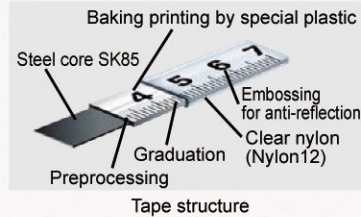

Tape structure



Swing damper



Graduation

► FEATURES

- Nylon coated steel tape (Nylon 12)
- ABS open reel, 3X quick winding
- JIS 1st class : Certified by Japan Industrial Standards
- 1mm graduation, and washable tape and case
- Swing damper absorb shock when winding
- Replacement tape, ABS case & handle are available as spare parts

► SPECIFICATIONS

PRODUCT NAME	MODEL	PKG QTY	MOQ	CODE NO.	C/O
Nylon Coated Steel Tape / 30m	MYS-30	10	10	218433	CN
Nylon Coated Steel Tape / 50m	MYS-50	10	10	218434	CN
Replacement Tape / 30m	MYS-30R	-	10	21843301	CN
Replacement Tape / 50m	MYS-50R	-	10	21843401	CN

Model	MYS-30	MYS-50
Packing size	310 x 190 x 47mm	338 x 229 x 47mm
Weight	900g	1,200g
Tape length	30m	50m
Tape width	10mm	10mm
Tape thickness	0.46mm	0.46mm
Tape tension	50N / 20degree	50N / 20degree

Nylon Coated Steel Tape Fast Winding

NR-X series



► FEATURES

- 1mm accurate graduation
- 3X quick winding
- Shock absorber for tape winding
- ABS case & grip rubber
- Replacement tapes are available
- Certified by JIS

► SPECIFICATIONS

Tape width : 10mm
Tape thickness : 0.5mm
Tape tension : 50N / 20 degree

PRODUCT NAME	MODEL	PKG QTY	MOQ	CODE NO.	C/O
Nylon Coated Steel Tape / 30m / 980g	NR30X	10	10	210451	JP
Nylon Coated Steel Tape / 50m / 1,370g	NR50X	10	10	123184	JP
Nylon Coated Steel Tape / 100m / 2,300g	NR100X	5	5	216279	JP

Nylon Coated Steel Tape

NR series



► FEATURES

- 1mm accurate graduation
- ABS case
- Replacement tapes are available
- Certified by JIS

► SPECIFICATIONS

Tape width : 10mm
Tape thickness : 0.5mm
Tape tension : 50N / 20 degree

PRODUCT NAME	MODEL	PKG QTY	MOQ	CODE NO.	C/O
Nylon Coated Steel Tape / 30m / 870g	NR30	10	10	123102	JP
Nylon Coated Steel Tape / 50m / 1,240g	NR50	10	10	123103	JP
Nylon Coated Steel Tape / 100m / 2,200g	NR100	5	5	500084	JP

Stainless Tape

STE series



► FEATURES

- Black graduation on stainless tape
- ABS case 3x quick winding (STE-30,50)
- Cross type metal case (STE-100)
- Certified by JIS

► SPECIFICATIONS

Tape width : 13mm
Tape tension : 20N / 20 degree

PRODUCT NAME	MODEL	PKG QTY	MOQ	CODE NO.	C/O
Stainless Tape / 30m / 1,000g	STE-30	10	10	216959	JP
Stainless Tape / 50m / 1,400g	STE-50	10	10	216960	JP
Stainless Tape / 100m / 2,750g	STE-100	5	5	216961	JP

Commencement of Measure

Please Choose 0 point of measuring tape.

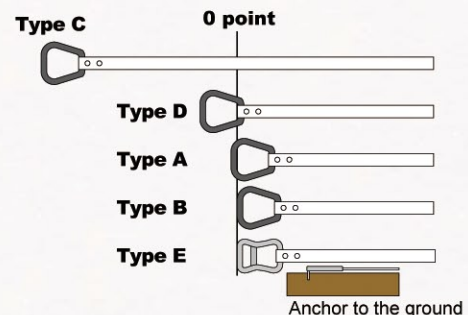

Fiberglass Tape 3X Fast Winding

MYG series

3X WINDING SPEED

Special gear mechanism can be wound 3x faster.

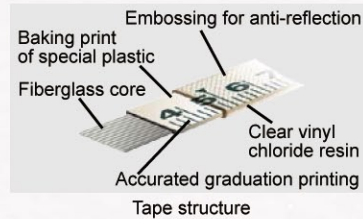

Graduation

► FEATURES

- PVC coated fiberglass tape
- ABS open reel, 3X quick winding
- JIS 1st class : Certified by Japan Industrial Standards
- Washable and elastomeric coating grip
- Replacement tape, ABS case & handle are available as spare parts

► SPECIFICATIONS

Model	MYG-30	MYG-50
Packing size	276 x 182 x 51mm	325 x 226 x 51mm
Weight	700g	930g
Tape length	30m	50m
Tape width	13mm	13mm
Tape thickness	0.55mm	0.55mm
Tape tension	20N/ 20degree	20N / 20degree

PRODUCT NAME	MODEL	PKG QTY	MOQ	CODE NO.	C/O
Fiberglass Tape / 30m	MYG-30	10	10	218435	CN
Fiberglass Tape / 50m	MYG-50	10	10	218436	CN
Replacement Tape / 30m	MYG-30R	-	10	21843501	CN
Replacement Tape / 50m	MYG-50R	-	10	21843601	CN

Fiberglass Tape Fast Winding

OTR-X series



► FEATURES

- PVC coated fiberglass tape
- 3X winding speed
- Easy to grip by rubber grip
- Double face graduation printing
- Replacement tapes are available
- Certified by JIS

► SPECIFICATIONS

Tape width : 12.5mm
Tape thickness : 0.47mm
Tape tension : 20N / 20 degree

PRODUCT NAME	MODEL	PKG QTY	MOQ	CODE NO.	C/O
Fiberglass Tape / 30m / 775g	OTR30X	10	10	210450	JP
Fiberglass Tape / 50m / 1,020g	OTR50X	10	10	123185	JP
Fiberglass Tape / 100m / 1,700g	OTR100X	5	5	216278	JP

Fiberglass Tape

OTR series



► FEATURES

- PVC coated fiberglass tape
- One side has 2mm graduation
- Another side has 5mm graduation
- ABS case
- Certified by JIS

► SPECIFICATIONS

Tape width : 12.5mm
Tape thickness : 0.47mm
Tape tension : 20N / 20 degree

PRODUCT NAME	MODEL	PKG QTY	MOQ	CODE NO.	C/O
Fiberglass Tape / 30m / 670g	OTR30	10	10	123159	JP
Fiberglass Tape / 50m / 915g	OTR50	10	10	123160	JP
Fiberglass Tape / 100m / 1,490g	OTR100	5	5	212080	JP

Fiberglass Tape Fast Winding

MR series



► FEATURES

- PVC coated fiberglass tape
- 3X winding speed
- Easy to grip by rubber grip
- Double face graduation printing
- Shock absorber for tape end
- ABS case covers whole tape
- Certified by JIS

► SPECIFICATIONS

Tape width : 12.5mm
Tape thickness : 0.47mm
Tape tension : 20N / 20 degree

PRODUCT NAME	MODEL	PKG QTY	MOQ	CODE NO.	C/O
Fiberglass Tape / 30m / 800g	MR3S30	10	10	218975	JP
Fiberglass Tape / 50m / 1,200g	MR3S50	10	10	218976	JP

Fiberglass Tape

HRW series



► FEATURES

- PVC coated fiberglass tape
- Double face graduation printing
- 3X quick winding
- Replacement tapes are available
- Certified by JIS

► SPECIFICATIONS

Tape width : 12mm
Tape thickness : 0.52mm
Tape tension : 10N / 20 degree

PRODUCT NAME	MODEL	PKG QTY	MOQ	CODE NO.	C/O
Fiberglass Tape / 30m / 1,000g	12-30HRW	10	10	210105	JP
Fiberglass Tape / 50m / 1,400g	12-50HRW	10	10	210106	JP
Fiberglass Tape / 100m / 2,750g	12-100HRW	5	5	212776	JP

Pocket Measuring Tape

MK series

ECONOMICAL

For the user who needs simple design.



▶ FEATURES

- Economical model
- Simple design
- Various colors

▶ COLOR



▶ SPECIFICATIONS

Model	MKS1955	MKS2555
Length	5.5m	5.5m
Tape width	19mm	25mm
Weight	195g	235g

PRODUCT NAME	MODEL	PKG QTY	MOQ	CODE NO.	C/O
Measuring Tape 5.5m / 19mm	MKS1955	12	12	221864	CN
Measuring Tape 5.5m / 25mm	MKS2555	12	12	-	CN

Pocket Measuring Tape

MAG series

ANTI-DROP

It doesn't need to worry about dropping by safety wire.



Safety wire

▶ FEATURES

- Easy to hook by magnet
- Corrosion proof by stainless spring
- Stainless spring for corrosion proof
- Certified by JIS
- Magnet holder holds tape measure
Magnet holder width : within 64mm
Magnet holder thickness : within 6mm



Attached by strong magnet

▶ SPECIFICATIONS

Model	MAG2555	MAG2575
Length	5.5m	7.5m
Tape width	25mm	25mm
Weight	400g	480g

▶ STANDARD ACCESSORIES

- Safety wire
- Magnet holder

PRODUCT NAME	MODEL	PKG QTY	MOQ	CODE NO.	C/O
Measuring Tape 5.5m / 25mm	MAG2555	4	4	218102	CN
Measuring Tape 7.5m / 25mm	MAG2575	4	4	218103	CN

Pocket Measuring Tape

GDK series

SMALLEST CLASS

GDK fit comfortably in your hand.



GDK1955

GDK2555H

▶ FEATURES

- Shock absorbing by GOM guard and damper function
- Corrosion proof by stainless spring
- Certified by JIS

▶ SPECIFICATIONS

Model	GDK1955	GDK2555	GDK2575
Size	125 x 91 x 65mm	125 x 91 x 65mm	133 x 115 x 70mm
Length	5.5m	5.5m	7.5m
Tape width	19mm	25mm	25mm
Weight	265g	313g	417g

Model	GDK25100	GDK2555H
Size	133 x 115 x 70mm	133 x 110 x 70mm
Length	10m	5.5m
Tape width	25mm	25mm
Weight	539g	368g

PRODUCT NAME	MODEL	PKG QTY	MOQ	CODE NO.	C/O
Measuring Tape 5.5m / 19mm	GDK1955	4	4	218494	CN
Measuring Tape 5.5m / 25mm	GDK2555	4	4	218496	CN
Measuring Tape 7.5m / 25mm	GDK2575	4	4	218972	CN
Measuring Tape 10m / 25mm	GDK25100	4	4	218973	CN
Measuring Tape with holder 5.5m / 25mm	GDK2555H	4	4	218974	CN

Pocket Measuring Tape

MGN series

MAGNESIUM

It's extra light and compact by magnesium made.



▶ FEATURES

- The smallest & lightest, but tough body
- Magnesium alloy body & tough
- Stainless spring for corrosion proof
- Certified by JIS
- Double face graduation

▶ SPECIFICATIONS

Model	MGN1955	MGN2555
Size	56 x 60 x 28mm	56 x 60 x 36mm
Weight	220g	265g
Length	5.5m	5.5m
Tape width	19mm	25mm

PRODUCT NAME	MODEL	PKG QTY	MOQ	CODE NO.	C/O
Measuring Tape 5.5m / 19mm	MGN1955	4	4	218511	JP
Measuring Tape 5.5m / 25mm	MGN2555	4	4	218213	JP

Non Conductive Measuring Tape

NS series

NON CONDUCTIVE

It's good for working on a railway.



Flexible tape

► FEATURES

- Non-conductive tape
- Using Kevlar fiber material for tape
- Plastic hook
- Compact size, and light weight

► SPECIFICATIONS

Tape width : 19mm
Length : 3.5m
Weight : 115g



Graduation

PRODUCT NAME	MODEL	PKG QTY	MOQ	CODE NO.	C/O
Non-conductive Measuring Tape	ND1935	6	6	210452	JP

Non Conductive Measuring Tape

GC30N

NON CONDUCTIVE

It's good for working on a railway.



Hard tape for aerial work

► FEATURES

- Expansion-free fiberglass tape
- FRP tape with urethane coating
- ABS case with light weight
- Polycarbonate hook

► SPECIFICATIONS

Insulation performance
Dry : 20kV or over / 10cm
Wet : 20kV or over / 10cm
Length : 3m
Tape width : 19mm
Weight : 150g



Graduation

PRODUCT NAME	MODEL	PKG QTY	MOQ	CODE NO.	C/O
Non-conductive Measuring Tape	GC30N	6	6	218389	JP

Pocket Rod

MN25-02

VARIOUS PURPOSE

Detachable tape expand the possibility of your work.



MN25-02

MN25-02C

✓ CHECK



Removable Tape

► FEATURES

- 5mm graduation tape
- Good for construction field picture
- Compact size

► SPECIFICATIONS

Model	MN25-02	MN25-02C
Thickness	0.36m	0.36m
Graduation		
Front	5mm	1mm
Rear	5mm	5mm
Length	2m	2m
Tape width	25mm	25mm
Weight	111g	111g

PRODUCT NAME	MODEL	PKG QTY	MOQ	CODE NO.	C/O
Pocket Rod	MN25-02	10	10	123298	MY
Pocket Rod 1mm graduation	MN25-02C	10	10	220979	MY

Measuring Tape for Depth

STT series

TANK SCALE

It's the best to measure the depth such as sea, tank so on.



► FEATURES

- Fast to measure the depth by weight
- Stainless frame case & tape
- 350g brass made weight
- Certified by JIS

► SPECIFICATIONS

Model	STT-5	STT-10
Tape width	13mm	13mm
Size	W105 x D33 x H105mm	W105 x D33 x H105mm
Length	5m	10m
Weight	900g	1,000g

Model	STT-20	STT-30
Tape width	13mm	13mm
Size	W105 x D33 x H105mm	W105 x D33 x H105mm
Length	20m	30m
Weight	1,200g	1,400g

PRODUCT NAME	MODEL	PKG QTY	MOQ	CODE NO.	C/O
Measuring Tape for Depth 5m	STT-5	1	1	216962	JP
Measuring Tape for Depth 10m	STT-10	1	1	216963	JP
Measuring Tape for Depth 20m	STT-20	1	1	216965	JP
Measuring Tape for Depth 30m	STT-30	1	1	216967	JP

Precision Diameter Tape

D-V series

ACCURATE MEASURING

It's good to measure the diameter accurately.

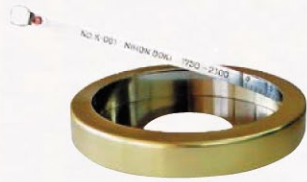

- ▶ **FEATURES**
 - Good for inspection
 - Quite accurate
- ▶ **SPECIFICATIONS**
 - Material : SUS301
 - Tape width : 6.5mm
 - Tape thickness : 0.20 ± 0.01mm

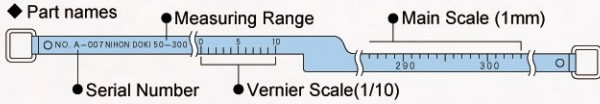

PRODUCT NAME	MODEL	PKG QTY	MOQ	CODE NO.	C/O
Diameter Tape 50~300mm	D-3V	1	1	218959	JP
Diameter Tape 250~600mm	D-6V	1	1	218960	JP
Diameter Tape 550~900mm	D-9V	1	1	218961	JP
Diameter Tape 850~1,200mm	D-12V	1	1	218962	JP
Diameter Tape 1,150~1,500mm	D-15V	1	1	218963	JP

Circumference Tape

S8

COMPACT & ACCURATE

This is circumference measuring tape. It's compact by rewinding.



- ▶ **FEATURES**
 - Compact by ABS plastic case (45mm)
 - Flat tape
 - Japanese Industrial Standard passed
- ▶ **SPECIFICATIONS**
 - Material : Steel
 - Tape width : 8mm
 - Case : ABS Plastic Case

PRODUCT NAME	MODEL	PKG QTY	MOQ	CODE NO.	C/O
Circumference Tape 2m	S8-2	1	10	-	JP
Circumference Tape 3m	S8-3	1	10	-	JP
Circumference Tape 5m	S8-5	1	10	-	JP

Diameter Tape

F10-02DM



- ▶ **FEATURES**
 - Flat tape, 10mm width
 - Easy to find out diameter when measuring circumference
- ▶ **SPECIFICATIONS**
 - Length : 2m
 - Size : 49φ x 15mm
 - Weight : 70g
 - Tape width : 10mm

PRODUCT NAME	MODEL	PKG QTY	MOQ	CODE NO.	C/O
Diameter Tape	F10-02DM	12	12	216730	JP

Caliper for Wooden Diameter

SSS series



- ▶ **FEATURES**
 - Good for measuring diameter
- ▶ **SPECIFICATIONS**
 - Material : Stainless SUS410
 - Graduation
 - Front : 2mm each
 - Rear : 1mm each

PRODUCT NAME	MODEL	PKG QTY	MOQ	CODE NO.	C/O
Caliper 30cmφ / 278g	SSS-30	-	1	213470	JP
Caliper 60cmφ / 597g	SSS-60	-	1	213472	JP
Caliper 75cmφ / 1,127g	SSS-75	-	1	213473	JP
Caliper 100cmφ / 1,575g	SSS-100	-	1	213474	JP

Diameter Tape

CM series



- ▶ **FEATURES**
 - Measuring diameter & circumference
 - White steel tape
- ▶ **SPECIFICATIONS**
 - Graduation
 - Front : Diameter (0.5mm each)
 - Rear : Circumference (1mm each)
 - Size : W88 x D88 x H30mm
 - Tape width : 10mm

PRODUCT NAME	MODEL	PKG QTY	MOQ	CODE NO.	C/O
Diameter Tape 3m / 220g	CM-3	1	1	217455	JP
Diameter Tape 5m / 250g	CM-5	1	1	217456	JP
Diameter Tape 10m / 295g	CM-10	1	1	217457	JP

Caliper for Wooden Diameter

TCW series

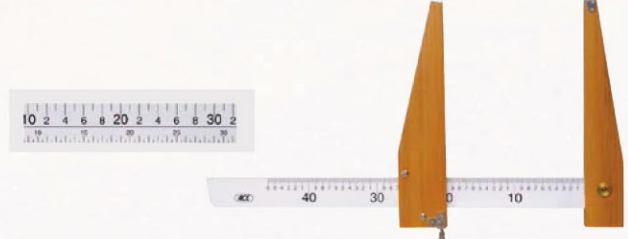

- ▶ **FEATURES**
 - Good for measuring diameter
 - Easy to read by big graduation
- ▶ **SPECIFICATIONS**
 - Graduation
 - Front : 2mm each
 - Rear : (upper) 1cm each
(Japan's special reading)
(lower) 5mm each

PRODUCT NAME	MODEL	PKG QTY	MOQ	CODE NO.	C/O
Caliper 30cmφ / 380g	TCW-30	-	1	217288	JP
Caliper 60cmφ / 620g	TCW-60	-	1	217290	JP
Caliper 75cmφ / 700g	TCW-75	-	1	217291	JP
Caliper 100cmφ / 860g	TCW-100	-	1	218111	JP

Fiberglass Surveyor's Rope

LN series



- ▶ **FEATURES**
 - Fiberglass surveyor's rope
- ▶ **SPECIFICATIONS**
 - Material : Fiberglass
 - Tension : 10N
 - Graduation : 5cm each
 - Rope width : 6.3mm
 - Thickness : 2mm

PRODUCT NAME	MODEL	PKG QTY	MOQ	CODE NO.	C/O
Surveyor's Rope / 30m / 0.6kg	30-LN	1	10	123207	JP
Surveyor's Rope / 50m / 1.0kg	50-LN	1	10	123208	JP
Surveyor's Rope / 100m / 1.9kg	100-LN	1	10	123209	JP

Fiberglass Surveyor's Rope

GR5 series



- ▶ **FEATURES**
 - Good for measuring a depth
 - Less water flow friction by fiberglass
 - Hook for weight
- ▶ **SPECIFICATIONS**
 - Material : Fiberglass
 - Rope diameter : 5mm φ
 - Graduation : 50cm each (red)
1m each (black)
 - Tension : 20N

PRODUCT NAME	MODEL	PKG QTY	MOQ	CODE NO.	C/O
Surveyor's Rope / 20m / 0.7kg	GR5-20	1	10	123222	JP
Surveyor's Rope / 30m / 1.0kg	GR5-30	1	10	123223	JP
Surveyor's Rope / 50m / 1.5kg	GR5-50	1	10	123224	JP

Fiberglass Surveyor's Rope

MSR series



- ▶ **FEATURES**
 - Strong but light
 - Fiberglass surveyor's rope
- ▶ **SPECIFICATIONS**
 - Tension : 20N / 20 degree
 - Graduation : 1cm each
 - Rope width : 6.2mm
 - Thickness : 2mm
 - Material : Fiberglass

PRODUCT NAME	MODEL	PKG QTY	MOQ	CODE NO.	C/O
Surveyor's Rope / 30m / 0.6kg	MSR30	1	10	123204	JP
Surveyor's Rope / 50m / 0.9kg	MSR50	1	10	123205	JP
Surveyor's Rope / 100m / 1.8kg	MSR100	1	10	123206	JP

Surveyor's Rope

PR4 series



- ▶ **FEATURES**
 - Float on the water
 - Chemical fiber rope
- ▶ **SPECIFICATIONS**
 - Material : Chemical fiber
 - Rope diameter : 4mm φ
 - Graduation : 1m each

PRODUCT NAME	MODEL	PKG QTY	MOQ	CODE NO.	C/O
Surveyor's Rope / 50m / 0.5kg	PR4-50	1	10	123210	JP
Surveyor's Rope / 100m / 0.9kg	PR4-100	1	10	123211	JP
Surveyor's Rope / 200m / 1.8kg	PR4-200	1	10	123212	JP

Surveyor's Wire Rope

SSR series

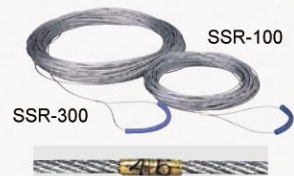

- ▶ **FEATURES**
 - Good for measuring on riverside or lakeside
- ▶ **SPECIFICATIONS**
 - Material : Steel
 - Rope diameter : 3mm
 - Graduation : 1m each
 - Weight : 3.4kg / 100m

PRODUCT NAME	MODEL	PKG QTY	MOQ	CODE NO.	C/O
Wire Rope 100m	SSR-100	1	10	123225	JP
Wire Rope 200m	SSR-200	1	10	123226	JP
Wire Rope 300m	SSR-300	1	10	123227	JP
Wire Rope 400m	SSR-400	1	10	123228	JP
Wire Rope 500m	SSR-500	1	10	123229	JP

Rope Reel for Surveyor's Rope

ROPE REELS

ORGANIZING

Professional is an organized person.



HSF-1N



OT-1



R-CASE



MSR-C

▶ SPECIFICATIONS

MODEL	HSF-1	OT-1	R-CASE	MSR-C
Wind-up	up to 200m	up to 600m	up to 100m	up to 100m
Weight	3.2kg	9kg	2.1kg	1.3kg

PRODUCT NAME	MODEL	PKG QTY	MOQ	CODE NO.	C/O
Rope Reel (for PR4 series)	HSF-1N	1	2	123214	JP
Rope Reel (for SSR series)	OT-1	1	2	123230	JP
Rope Reel (for LN series)	R-CASE	1	2	102151	JP
Rope Reel (for MSR series)	MSR-C	1	2	218522	JP

Sinker for Surveyor's Rope

SINKERS



RR-3

RR-5

- ▶ **FEATURES**
 - Necessary for measuring depth
- ▶ **SPECIFICATIONS**

Model	RR-3	RR-5
Available rope length	under 30m	under 50m
Size	H230xW60mm	H220xW75mm
Weight	3.2kg	5kg

PRODUCT NAME	MODEL	PKG QTY	MOQ	CODE NO.	C/O
Sinker 3.2kg	RR-3	1	2	123220	JP
Sinker 5kg	RR-5	1	2	123221	JP

NEW Measuring Wheel MG series

WALK TO MEASURE

It is easy to measure a distance by just walking.



▶ FEATURES

- Magnifying counter lens
- Soft grip fits just in hand
- Kickstand(MG-200 only)
- Counter on hand (MG-200 only)

▶ SPECIFICATIONS

Model	MG-100	MG-200
Minimum reading	1cm	10cm
Measuring range	1km	10km
Full closed	46cm	50cm
Full extended	96cm	100cm
Wheel size	9.6cm φ	19cm φ
Weight	360g	1.2kg

PRODUCT NAME	MODEL	PKG QTY	MOQ	CODE NO.	C/O
Measuring Wheel / 1cm ~ 1km	MG-100	1	4	222302	TW
Measuring Wheel / 10cm ~ 10km	MG-200	4	4	222303	TW

Measuring Wheel WALKING MEASURE

RESPONSIBLE COUNTER

This measuring wheel uses the quality counter.



▶ FEATURES

- Compact size for easy carrying
- The pole length is adjustable by twist locking.

▶ SPECIFICATIONS

Model	C10-S	C10-D	B20-S	B20-D
Wheel	Single	Double	Single	Double
Resolution	1cm	1cm	10cm	10cm
Measuring range	1km	1km	10km	10km
Full closed	540mm	490mm	640mm	640mm
Full extended	890mm	840mm	980mm	890mm
Wheel size	10cm φ	10cm φ	20cm φ	20cm φ
Weight	430g	600g	850g	1,400g



5 digits indication

PRODUCT NAME	MODEL	PKG QTY	MOQ	CODE NO.	C/O
Measuring Wheel 10cmφ / Single wheel	C10-S	1	10	082351	JP
Measuring Wheel 10cmφ / Double wheel	C10-D	1	10	082352	JP
Measuring Wheel 20cmφ / Single wheel	B20-S	1	10	082353	JP
Measuring Wheel 20cmφ / Double wheel	B20-D	1	10	082354	JP

Measuring Wheel DIGITAL MEASURE

JAPAN MADE

This is quite popular in Japan.



▶ FEATURES

- Compact size for easy carrying
- Waterproof housing for counter
- The pole length is adjustable by twist locking.

▶ SPECIFICATIONS

Model	D-1N	D-2	D-3
Resolution	10cm	10cm	10cm
Measuring range	10km	10km	10km
Full closed	510mm	-	280mm
Full extended	950mm	980mm	1060mm
Wheel size	32cm φ	32cm φ	16cm φ
Circumference	1m	1m	50cm
Stick	Twist lock	Straight	Pin lock
Weight	1.2kg	1.74kg	0.57kg

Waterproof counter
5 digits indication

PRODUCT NAME	MODEL	PKG QTY	MOQ	CODE NO.	C/O
Measuring Wheel 32cm φ	D-1N	1	2	220911	JP
Measuring Wheel with kickstand 32cm φ	D-2	1	2	220912	JP
Measuring Wheel 16cm φ	D-3	1	2	220913	JP

Measuring Wheel D-4 / M6-S

EXTRA COMPACT

It is easy to carry by extra compact.



D-4
Extra compact

▶ FEATURES

- Pin lock stick & compact storage
- Easy to carry by light weight
- Good for measuring outside & inside

▶ SPECIFICATIONS

Model	D-4	M6-S
Resolution	1cm	1cm
Measuring range	1km	1km
Full closed	26cm	39cm
Full extended	103cm	83cm
Wheel size	10cm φ	6cm φ
Weight	0.44kg	0.40kg

PRODUCT NAME	MODEL	PKG QTY	MOQ	CODE NO.	C/O
Measuring Wheel 10cm φ	D-4	1	2	220914	JP
Measuring Wheel 6cm φ	M6-S	1	2	211215	JP

COMPACT & STYLISH

It is compact & stylish, blue color increase the visibility.



Extra compact
M6-S

▶ FEATURES

- Pin lock stick & compact closed
- Stable turning by wide tire
- Good for inside working

▶ STANDARD ACCESSORIES

- Carrying case (M6-S)

Chalk Liner

MLN50

2X FAST WINDING

It's quite fast to wind the string.



► FEATURES

- Cotton blended yarn with polyester
- Max 3mm wide line can be marked
- Remained amount checkable
- 2X speed string winding
- Good for road construction

► SPECIFICATIONS

Size : 425 x 270 x 110mm
 Weight : 763g
 Length : 50m

PRODUCT NAME	MODEL	PKG QTY	MOQ	CODE NO.	C/O
Chalk Liner	MLN50	10	10	215756	JP
Replacement String 50m	L3-50	10	10	213476	JP

Glow Leveling Line

FCS series

CHECK LEVEL

This is used when checking the level.



► FEATURES

- Easy to see by 3mm φ & glow color
- Stretch rubber thread

► SPECIFICATIONS

Model	FCS-Y	FCS-P
Size	54 x 172mm	54 x 172mm
Length	3mm φ x 30m	3mm φ x 30m
Color	Yellow	Pink

PRODUCT NAME	MODEL	PKG QTY	MOQ	CODE NO.	C/O
Glow Leveling Line Yellow	FCS-Y	10	10	214040	CN
Glow Leveling Line Pink	FCS-P	10	10	214041	CN

Chalk Liner

ML50

LARGE CAPACITY

Just one refill brings your prolonged work.



► FEATURES

- Cotton blended yarn with polyester
- Max 3mm wide line can be marked
- Good for road construction



► SPECIFICATIONS

Size : 325 x 205 x 80mm
 Length : 50m
 Weight : 560g

PRODUCT NAME	MODEL	PKG QTY	MOQ	CODE NO.	C/O
Chalk Liner Large size	ML-50	10	10	210122	JP
Replacement String 50m	L3-50	10	10	213476	JP

Chalk Powder for Liner

CHALK POWDER

HEAVY POWDER

It's antiscattering by heavy powder.



► FEATURES

- Slim bottle case
- 6 colors
- Colorfast by sealed bottle

► SPECIFICATIONS

Size : 60mm φ x H195mm
 Content : 300g

PRODUCT NAME	MODEL	PKG QTY	MOQ	CODE NO.	C/O
Chalk Powder White	2201	6	6	220980	JP
Chalk Powder Blue	2202	6	6	220981	JP
Chalk Powder Yellow	2203	6	6	220982	JP
Chalk Powder Red	2204	6	6	220983	JP
Chalk Powder Pink	2211	6	6	220984	JP
Chalk Powder Green	2212	6	6	220985	JP

Laser Rangefinder

TRU PULSE

MULTI FUNCTION

TRU PULSE inform the various values such as angle, distance, or height.



SPECIFICATIONS

Measuring range	: 0 ~ 1,000m (min. 10cm)
Accuracy 1	: ± 30cm (1ft) (to typical target)
Accuracy 2	: ± 0.3 ~ 1m (1 ~ 3ft) (to very distant & weak targets)
Inclination sensor	: Sensing ± 90°
Inclination accuracy	: ± 0.25°
Size	: 50 x 120 x 90mm
Weight	: 285g
Water and dust resistance	: IP54
Display	: 7X / LCD
Power	: AA alkaline batteries x 2 / CRV3 lithium x 1

FEATURES

- 11 types of distances, heights & angle measurement can be done in a moment by simple operation.

ACCESSORIES

- Carrying case
- Strap
- Instruction
- Serial tag (Attached on body)
- Certificate & Contact card

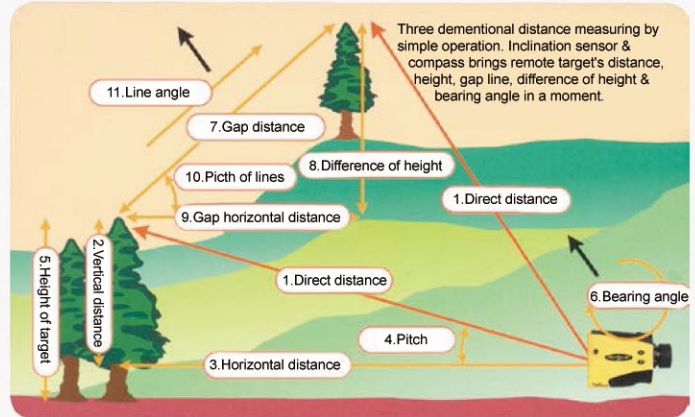

PRODUCT NAME	MODEL	PKG QTY	MOQ	CODE NO.	C/O
Laser Rangefinder TruPulse	TRU PULSE360	1	1	217568	JP

Tally Counter

TALLY COUNTER

WITHOUT COUNT LOSS

This is simple function, but there are so much know-how.



SPECIFICATIONS

Digits : 4 digits

REMARKS

- Handheld model (H102-4)
- Desk model (H404-4)
- Quintuplets (HM404-5)

PRODUCT NAME	MODEL	PKG QTY	MOQ	CODE NO.	C/O
Tally Counter Hand / 66g	H102-4	1	10	082371	JP
Tally Counter Desk / 95g	H404-4	1	10	082372	JP
Tally Counter 5-joint / 410g	HM404-5	1	2	082374	JP

Digital Tally Counter

TALLY COUNTER

BIG LETTER

Digital display shows big letter to increase the visibility.



CHECK

FUNCTIONS

COUNT MODE

General function. It's count-up by each time pushing button.

CALCULATION MODE

2 counters in one. It can be counted in parallel. 2 values can be added and subtracted.

ALARM MODE

Beep when reaching the set value.

MEMORY MODE

10 values recordable. After recalling the value from memory, count can be restarted.

FEATURES

- Compact
- Big letter
- Several functions selectable

SPECIFICATIONS

Measuring range	: -9,999 ~ 99,999
Size	: 63 x 52 x 35mm
Weight	: 50g
Auto power off	: 30seconds

PRODUCT NAME	MODEL	PKG QTY	MOQ	CODE NO.	C/O
Digital Tally Counter	73310	6	12	-	CN

Stopwatch

HS series

HIGH FUNCTIONABLE

They have many functions to support your work.



HS43-001

HS45-001

PRODUCT NAME	MODEL	PKG QTY	MOQ	CODE NO.	C/O
Stopwatch	HS43-001	1	20	215457	CN
Stopwatch	HS45-001	1	20	213925	CN

▶ FEATURES

- Rap and split time measurable
- 1/100 sec. measurable
- 5 atm water resistant

✓ CHECK

VARIOUS FUNCTIONS

	HS43-001	HS45-001
STOPWATCH	○	○
TIMER	×	○
PACEMAKER	×	○
TIME	○	○
ALARM	○	○

*STOP WATCH : Rap, Split, and Total Time. Up to 10 hours

*PACEMAKER : Number of times per min. from 10 to 320 are set in advance.

Number of times and operating time are displayed simultaneously.

▶ SPECIFICATIONS

Model	HS43-001	HS45-001
Accuracy	1min. / month	1min. / month
Operating temperature	0 ~ + 40°C	0 ~ + 40°C
Power	CR2032 x 1	CR2032 x 1
Battery life	approx. 10 years	approx. 3 years

Digital Curvimeter

COMCURVE 10

COMPACT & HIGH PERFORMANCE

Easy to use by pen-shaped, and moreover it has high performance.



Data receiver CV-10RCV (option)

▶ FEATURES

- Measuring a distance in a moment by tracing map & drawing
- Data can be transported to PC with CV-10RCV (option)

▶ SPECIFICATIONS

Measuring range	: 10m
Minimum reading	: 1mm
Accuracy	: within ± 0.3%
Display unit	: mile, yd, ft, in, mm, cm, m & km
Measuring function	: Scale size measuring function
Size	: 170 x 22 x 23mm (incl. cap)
Weight	: approx. 65g (incl. batteries)
Power	: AAA batteries x 2
Scale size	: Any scale size (1:1 ~ 1:99999)

PRODUCT NAME	MODEL	PKG QTY	MOQ	CODE NO.	C/O
Digital Curvimeter	COMCURVE-10	1	10	218754	JP
Data Receiver	CV-10RCV	1	10	219061	JP

Curvimeter

MM-1

POCKET SIZE

This small device contains a handle support accurate tracing.



Front

Back



▶ SPECIFICATIONS

Size	: 97 x 46 x 16mm
Package	: Blister package
Weight	: 25g
Material	: ABS
Scale size	: 1:1, 1:20000, 1:25000, 1:50000, 1:70000

PRODUCT NAME	MODEL	PKG QTY	MOQ	CODE NO.	C/O
Curvimeter	MM-1	1	10	217569	HK

Planimeter

PLACOM

ADVANCED FUNCTIONS

Advanced features for exceptional cost performance meet all of your present and future needs.



KP-21C
New era of planimeter



Data out-put

Function key

Tracer arm

Plot-key

► FEATURES

- Area, length, segmental length and coordinates
- Removable printer for recording results
- The ability to upload data and transfer it to computers

► SPECIFICATIONS

Model	KP-21C
Measurement functions	Roller type Area, Length, Segmental length, Coordinates
Measurements	Metric : mm, cm, m, km Imperial : in, ft, yd, miles
Display	16 digit x 2 line dot matrix LCD
Interface	Exclusive removable printer or RS232C (option)
Measuring range	10m (horizontal max) 380mm (vertical max)
Minimum measuring length	0.05mm
Accuracy	within $\pm 0.1\%$
Power	Rechargeable NiCd battery, A/C power supply
Size	430 x 159 x 46mm (with printer)
Weight	970g

KP-80N/82N
Polar model



KP-90N/92N
Roller model

► FEATURES

- Measurement by 6 digits pulse count
- Maximum cumulative measurement value of 10m²
- Easy conversion function of unit and scale
- Hold memory function
- Automatic shifting of unit to upper unit
- Average value measurement
- Measurement of an area with different lateral & longitudinal scale
- Auto-power-off function for energy saving

► SPECIFICATIONS

Model	KP-90N	KP-92N	KP-80N	KP-82N
Type	Roller / computing	Roller / single	Polar / computing	Polar / computing
Display	Liquid crystal, 8-digit figures 13 symbols	Liquid crystal, 8-digit figures 6 symbols	Liquid crystal, 8-digit figures 13 symbols	Liquid crystal, 8-digit figures 6 symbols
Symbol	Batt-E, Scale, Memo, Hold, cm ² , m ² , km ² , in ² , ft ² , etc.	Batt-E, Memo, Hold, cm ² , ft ² , etc.	Batt-E, Scale, Memo, Hold, cm ² , m ² , km ² , in ² , ft ² , etc.	Batt-E, Memo, Hold, cm ² , in ² , etc.
Converting function	Unit & scale value	Unit (in ² , cm ²)	Unit & scale value	Unit (in ² , cm ²)
Accumulated measuring value	Maximum 10m ² (scale 1:1)	Maximum 10m ² (scale 1:1)	Maximum 10m ² (scale 1:1)	Maximum 10m ² (scale 1:1)
Measuring range	Vertical : 325mm Horizontal : Unlimited	Vertical : 325mm Horizontal : Unlimited	800mm ϕ *In case of setting pivot point inside pattern	800mm ϕ *In case of setting pivot point inside pattern
Accuracy	within $\pm 0.2\%$ (within $\pm 2 / 1,000$ pulses)	within $\pm 0.2\%$ (within $\pm 2 / 1,000$ pulses)	within $\pm 0.2\%$ (within $\pm 2 / 1,000$ pulses)	within $\pm 0.2\%$ (within $\pm 2 / 1,000$ pulses)
Power	1. Built-in NiCd battery (rechargeable through AC adaptor) 2. AC adaptor 100V ~ 240V	1. Built-in NiCd battery (rechargeable through AC adaptor) 2. AC adaptor 100V ~ 240V	1. Built-in NiCd battery (rechargeable through AC adaptor) 2. AC adaptor 100V ~ 240V	1. Built-in NiCd battery (rechargeable through AC adaptor) 2. AC adaptor 100V ~ 240V
Operating time	approx. 30 hours	approx. 30 hours	approx. 30 hours	approx. 30 hours
Battery charging time	approx. 15 hours	approx. 15 hours	approx. 15 hours	approx. 15 hours
Main unit weight	750g	750g	780g	780g

PRODUCT NAME	MODEL	PKG QTY	MOQ	CODE NO.	C/O
Planimeter Printer Model	KP-21C	1	1	212122	JP
Planimeter Roller Model	KP-90N	1	1	082316	JP
Planimeter Roller Model	KP-92N	1	1	082317	JP
Planimeter Polar Model	KP-80N	1	1	082318	JP
Planimeter Polar Model	KP-82N	1	1	082319	JP

► STANDARD ACCESSORIES (KP-90N , KP-92N , KP-80N , KP-82N)

- Supplied AC adaptor
- Plastic case

Planimeter

MARBLE PX-10S

STYLISH & HIGH PERFORMANCE

Marble focus on not only design but operability and functionality.



✓ CHECK

EASY OPERATION

Plot key is now right next to the trace lens, allowing you to operate the new Marble easily with one hand.



► FEATURES

- Various scale available

► SPECIFICATIONS

- Measuring functions : Area, line, and side length
- Measuring units : mm, cm, m, km, in, ft, acre/yd
- Measuring range : 300mm x 10m
- Accuracy : ± 0.1% (for an area of 100 x 100mm)
- Display : LCD 16 digits on lines
- Minimum line reading : ± 0.05mm
- Power : Internal nickel metal hydrate battery
AC charger & adapter
- Operating time : 20 hours
- Charging time : 15 hours
- Dimensions : 250 x 110 x 40mm
- Weight : 630g (w/o case)
- Resolution : ± 0.05mm

► STANDARD ACCESSORIES

- Carrying case
- AC charger & adapter

PRODUCT NAME	MODEL	PKG QTY	MOQ	CODE NO.	C/O
Planimeter Marble	PX-10S	1	1	212542	JP

Laser Plumb Bob

DPV03 / WPV02

VERTICAL FINDER

Pendulum laser bring the right vertically.



Extension pole (DPV03 only)

✓ CHECK

Magnetic damper slow down and stop the pendulum swing. The vertical level can be checked from any angles.

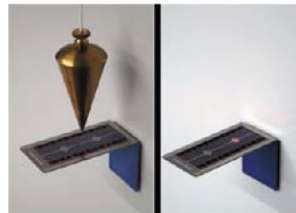

Visible at any angle



Turnbuckle adjustable

► FEATURES

- For checking the vertically of post
- Magnetic damper
- Unaffected by wind
- Compact

► STANDARD ACCESSORIES

- Extension pole (DPV03)
- Case (DPV03)
- Target plate (DPV03)
- Target plate x2 (WPV02)

► SPECIFICATIONS

Model	DPV03	WPV02
Accuracy	down ± 1mm / 3m	up ± 15mm / 15m down ± 1mm / 3m
Mechanism	X-Y Axis gimbal system within 2°	X-Y Axis gimbal system within 2°
Self-leveling	Magnetic damper	Magnetic damper
Compensator	Less than 1mW	Less than 1mW
Output	AAA batteries x 2	AAA batteries x 2
Power	approx. 34h	approx. 17h
Operating time	36 x 72.7 x 94mm	36 x 72.7 x 94mm
Size	228g (incl. batteries)	228g (incl. batteries)
Weight		

PRODUCT NAME	MODEL	PKG QTY	MOQ	CODE NO.	C/O
Laser Plumb Bob Down Point	DPV03	1	1	221029	JP
Laser Plumb Bob Up & Down Point	WPV02	1	1	221479	JP

NEW Digital Angle Level DIGILEVEL 3D

PRECISION 3D DIGITAL ANGLE LEVEL

DGL-3D provides angles on illuminated display for better visibility.



▶ FEATURES

- High accurate 360° measuring
- Digital direct reading
- Auto-reverse LED display
- 3D digital circular level
- Data hold, 0 set, calibration function
- Angle and slope simultaneous display
- 0 / 45 / 90° beeper function
- Blue backlight of tube vials

▶ SPECIFICATIONS

Resolution	: 0.05° • 0.1%
Reading accuracy	: ± 0.1° (0° / 45° / 90°) / ± 0.2° (Other)
Accuracy	: H ± 0.5mm / m (± 0.029°) V ± 0.75mm / m (± 0.043°)
Measuring range	: 4 x 90° (0 ~ 360°)
Operating temperature	: -5 ~ + 50°C
Auto power off	: 5 minutes
Power	: AA alkaline battery x 3
Size	: 600 x 33 x 72.5mm
Weight	: 770g



2 Measuring modes
Circular level & Angle measure

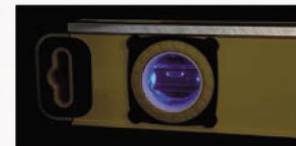

Blue LED backlight

✓ CHECK

Simple Controller

The big display shows angle, grade and indicator at a time without pushing the button.



PRODUCT NAME	MODEL	PKG QTY	MOQ	CODE NO.	C/O
Digital Angle Level	DGL-3D	1	1	221846	CN

Digital Angle Level DGL-C

COMPACT & CONVENIENT

Easy to read the value by the digital.



▶ FEATURES

- Attachable on metal by magnet
- Display will be up-side down if using up-side down
- Beep when 0 degree, 45 degree and 90 degree
- V-ditch and magnet on bottom part help to measure metal frame or pipe
- Numerical number on display can be held by "hold" button

▶ SPECIFICATIONS

Display mode	: Angle, slope (%) & pitch (IN/FT)
Min. display	: 0.1°, 0.1%
Digital measuring accuracy	: ± 0.1°
Vial accuracy	: ± 0.5mm / m (± 0.029°)
Power	: 1.5V AAA battery x 2
Length	: 210mm
Weight	: 237g (incl. batteries)
Operating temperature	: 0 ~ + 40°C
Size	: 210 x 52 x 31mm

▶ STANDARD ACCESSORIES

- Soft case
- Batteries (only for test use)
- Slope calculation sticker

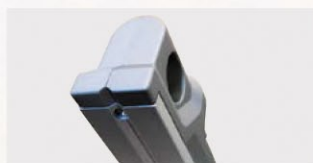

V-ditch on the bottom



Magnet on the bottom

PRODUCT NAME	MODEL	PKG QTY	MOQ	CODE NO.	C/O
Digital Angle Level	DGL-C	16	16	218756	CN

POWER / BEEP

Power up / Power down
Beep at 0, 45, 90 degree

CONVERT

Various units available
(°), (%), (in / ft)



ZERO

0 setting available at
arbitrary angle

HOLD

Numerical value are held

Digital Angle Level

DI LEVEL

WITH MAGNET

DI level has magnet at the bottom.



DI-100M

DI-230M

DI-600M

▶ FEATURES

- Attachable on metal by magnet
- Display will be up-side down if using up-side down (DI-230M & DI-600M)
- Auto power off
- V-ditch and magnet on bottom part help to measure metal frame or pipe
- Numerical number on display can be held by "hold" button
- Easy to calibrate

▶ SPECIFICATIONS

Model	DI-100M	DI-230M	DI-600M
Size	107 x 55 x 18mm	230 x 56 x 26mm	600 x 56 x 26mm
Accuracy (0°)	± 0.3°	± 0.05°	± 0.05°
Accuracy (90°)	± 0.3°	± 0.2°	± 0.2°
Display	Angle(0.1°) → %	Angle(0.1°) → Angle(0.05°) → % → mm/m	Angle(0.1°) → Angle(0.05°) → % → mm/m
Power	CR2032 x 2	CR2032 x 2	CR2032 x 2

PRODUCT NAME	MODEL	PKG QTY	MOQ	CODE NO.	C/O
Digital Angle Level 10cm	DI-100M	1	1	220002	JP
Digital Angle Level 23cm	DI-230M	1	1	-	JP
Digital Angle Level 60cm	DI-600M	1	1	-	JP

Waterproof Digital Angle Level

DWL-280Pro

WATERPROOF IP67

It works under inhospitable environment.



✓ CHECK



Waterproof IP67

▶ FEATURES

- Bright display
- Hold function
- With magnet
- Self-calibration

▶ SPECIFICATIONS

Measuring range	: 0 ~ 90°
Resolution	: 0.05°(1.0mm/m)
Unit	: °, mm/s, in/F, %
Operating temperature	: -20 ~ + 60°C
Power	: AAA battery x 3
Size	: 230 x 60 x 28mm
Weight	: 370g
Water & dust resistance	: IP67

PRODUCT NAME	MODEL	PKG QTY	MOQ	CODE NO.	C/O
Digital Angle Level	DWL-280Pro	1	2	221008	SG

Digital Angle Level

DG LEVEL

PROFESSIONAL USE

This is accurate and tough model, it is for professional.



ED-35DGLMN



Automatic digit inversion

▶ FEATURES

- 3 angle units (mm / m, degree,%) selectable
- With magnet
- Auto power off (6min.)

▶ STANDARD ACCESSORIES

- Soft case

▶ SPECIFICATIONS

Model	ED-35DGLMN	ED-60DGLMN
Size	350 x 60.5 x 26mm	600 x 60.5 x 26mm
Accuracy (0°,90°)	± 0.05°	± 0.05°
Display	Angle(0.05°) → % → mm/m	Angle(0.05°) → % → mm/m
Power	9V block	9V block
Weight	503g	765g

PRODUCT NAME	MODEL	PKG QTY	MOQ	CODE NO.	C/O
Digital Angle Level 35cm	ED-35DGLMN	1	2	217686	JP
Digital Angle Level 60cm	ED-60DGLMN	1	2	217688	JP

Digital Angle Level

DF LEVEL

LONG MODEL

Good for inspection of floor leveling.



ED-200DFCKN



Automatic digit inversion

▶ FEATURES

- Accurate calibration can be done at field
- Can be hold the measuring value
- Auto power off (6min.)

▶ STANDARD ACCESSORIES

- Soft case

▶ SPECIFICATIONS

Model	ED-150DFCKN	ED-200DFCKN
Size	1500 x 100 x 30mm	2000 x 100 x 30mm
Accuracy (0°,90°)	± 0.05°	± 0.05°
Display	Angle(0.05°) → % → mm/m	Angle(0.05°) → % → mm/m
Power	9V block	9V block
Weight	1,825g	2,825g

PRODUCT NAME	MODEL	PKG QTY	MOQ	CODE NO.	C/O
Digital Angle Level 1.5m	ED-150DFCKN	1	1	212354	JP
Digital Angle Level 2m	ED-200DFCKN	1	1	212352	JP

Precision Digital Angle Level

DWL-2000XY

BIAXIAL MEASURING

DWL-2000XY can measure biaxially at the same time.



FEATURES

- Accurate biaxial measurement
- Self-calibration
- Accuracy 0.02° (±0.00 ~ ±2.00°)

SPECIFICATIONS

Measuring range	
X	: 0 ~ 90.00°
Y	: 0 ~ 3.00°
Resolution	: 0.01° (175µm/m)
Accuracy	: ±0.02° (±0.00 ~ ±2.00°) ±0.04° (other range)
Repeatability	: 0.01° (175µm/m)
Operating temperature	: -10 ~ 50°C
Power	: AAA 1.5V battery x 4 / USB
Size	: 188 x 62 x 37mm
Weight	: 580g

PRODUCT NAME	MODEL	PKG QTY	MOQ	CODE NO.	C/O
Digital Angle Level	DWL-2000XY	1	1	220577	SG

Spirit Level

BOX LEVEL

BELIEVE WHAT I SEE

This is the standard model to check the level.



FEATURES

- I-beam frame
- V-ditch on measuring surface
- Magnet type is available
- Alumite treatment on the surface

SPECIFICATIONS

Model	L-160-150	L-160Q-600
Sensitivity	0.5mm / m (0.0286°)	0.5mm / m (0.0286°)
Accuracy	±1.5mm / m (within ±0.0859°)	±1.5mm / m (within ±0.0859°)
Size	150mm length	600mm length

Model	L-160Q-1200	L-160Q-2000
Sensitivity	0.5mm / m (0.0286°)	0.5mm / m (0.0286°)
Accuracy	±1.5mm / m (within ±0.0859°)	±1.5mm / m (within ±0.0859°)
Size	1,200mm length	2,000mm length

PRODUCT NAME	MODEL	PKG QTY	MOQ	CODE NO.	C/O
Spirit Level 150mm	L-160-150	10	10	-	JP
Spirit Level 600mm	L-160Q-600	10	10	500085	JP
Spirit Level 1,200mm	L-160Q-1200	1	5	500086	JP
Spirit Level 2,000mm	L-160Q-2000	1	5	-	JP

Luminous Angle Level

LT-M

USEFUL AT DARK PLACE

It is useful at dark place, because bubbles are lighted by LED.



FEATURES

- Work well on dark place
- Auto power off (10min.)
- With magnet

SPECIFICATIONS

Size	: 230 x 38 x 17mm
Accuracy	: ± 1.5mm/m = ± 0.0859°
Sensitivity	: 0.5mm/m = 0.0286°
Power	: AAA batteries x 2

PRODUCT NAME	MODEL	PKG QTY	MOQ	CODE NO.	C/O
Luminous Angle Level	LT-M	10	10	219651	JP

Slant Rule

SD-25SPRO

FEATURES

- Big graduation is easy to read
- Easy to operate by big dial
- V-ditch on the bottom part
- Magnet type is available

SPECIFICATIONS

Material	: ABS plastic
Size	: 150 x 250 x 15mm
Sensitivity	: 0.5mm / m = 0.0286°
Accuracy	: ± 17.5mm / m

PRODUCT NAME	MODEL	PKG QTY	MOQ	CODE NO.	C/O
Angle Meter	ED-25SPRO	6	6	213429	JP
Angle Meter with Magnet	ED-25SPROM	6	6	213429M	JP

Slant Rule

SR-90

FEATURES

- Matching for slope / angle measuring at many kinds of construction field
- V-ditch on the bottom part
- With magnet for metal pipe use

SPECIFICATIONS

Size	: 95 x 95 x 30mm
Graduation	: 90 ~ 0 ~ 90° 1 scale = 1°

PRODUCT NAME	MODEL	PKG QTY	MOQ	CODE NO.	C/O
Angle Meter	SR-90	5	5	210531	JP

Water Level Meter

ALFA WATER LEVEL METER

BUZZER FUNCTION

Notify the water level by buzzer and red light.



ALFA original circular rope

TYPE2
Notify the water level by buzzer and red light



Probe 13mmφ x 135mm

PRODUCT NAME	MODEL	PKG QTY	MOQ	CODE NO.	C/O
Water Level Meter Type2 30m / 1.5kg	2-30B	1	1	212767	JP
Water Level Meter Type2 50m / 1.8kg	2-50B	1	1	212768	JP
Water Level Meter Type2 100m / 2.6kg	2-100B	1	1	212769	JP

► FEATURES

- Compact and light body by plastic reel case
- Smooth rewinding without tangled-up wires
- One-touch battery change
- Working for water level measuring at dam, drilling well, river & lake

► SPECIFICATIONS

Model	Type2
Rope	2 core stainless wire rope
Minimum graduation	10mm
Outer diameter	4mmφ
Sensor	Stainless / 13mmφ
Reel case	ABS plastic
Water level detecting	Buzzer & red light
Power	006P 9V x 1
Dimensions	H260 x D150 x W190mm (30m)

The following types are also available.



TYPE1
Buzzer



TYPE3
Buzzer and red light
Display water temperature 0 ~100°C

Water Depth Meter

PS-7FL

EASY OPERATION AND INSTANT MEASUREMENT

For simple and handy check at the construction or survey site.



PS-7FL



PS-7 (50m waterproof)

► FEATURES

- Press the switch on the case for 2 to 3 seconds and hold the body in the direction of measurement
- Equipped float sensor and 10m cable enables measurement of remote location easily (PS-7FL)

► SPECIFICATIONS

Model	PS-7FL	PS-7
Channel	1CH	1CH
Depth range	0.6 ~ 80m	0.6 ~ 80m
Detective angle	15°(half of full angle)	24°(half of full angle)
Power	9V (dry cell 006P)	9V (dry cell 006P)
Operating temperature	0 ~ + 50°C	0 ~ + 50°C
Dimension (main unit)	42 x 198mm	42 x 198mm
Dimension (sensor)	50 x 155mm	-
Weight	approx. 170g + 450g	approx. 190g

PRODUCT NAME	MODEL	PKG QTY	MOQ	CODE NO.	C/O
Water Depth Meter 10m cable & Float	PS-7FL	1	1	082294	JP
Water Depth Meter	PS-7	1	1	219316	JP

Water Level Meter

WL series

TAPE TYPE WATER LEVEL METER

Notify the water level by buzzer.



► FEATURES

- Able to measure quickly
- Notify by buzzer when probe soak 1cm in water
- Sensitivity adjustable
- Self disconnection checking function



► SPECIFICATIONS

Model	WL-10M	WL-50M
Length	10m	50m
Probe size	19 φ x 140mm	19 φ x 140mm
Probe weight	100g	100g
Tape size	12.5 x 0.55mm	12.5 x 0.55mm
Graduation	2mm each	2mm each
Material	Probe: Stainless Tape: Fiberglass (non-lead stabilized PVC coating)	Probe: Stainless Tape: Fiberglass (non-lead stabilized PVC coating)
Case	ABS	ABS
Power	AA battery x 2	AA battery x 2
Battery life	24 hours	24 hours
Case size	219 x 156 x 56mm	354 x 277 x 56mm
Weight	600g	1,200g

PRODUCT NAME	MODEL	PKG QTY	MOQ	CODE NO.	C/O
Water Level Meter 10m	WL-10M	1	1	216285	JP
Water Level Meter 50m	WL-50M	1	1	102212	JP

Stream Gauge

STREAM GAUGE

STREAMFLOW OBSERVATION

This is for the measurement of flow and storage of water.



Standard design

Chuden design

AKK design

Reflective Image



All

Characters

None

► FEATURES

- Made-to-Order
- Durable material of steel, ABS resin & stainless staff
- Easy to read by clear number
- Special order can be accepted
- 3 type of shapes are available



► PLATE SHAPE

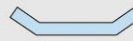

U-shape



Round-shape

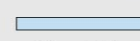

Straight

✓ CHECK

Made to Order

1. Graduation (Standard / Chuden / AKK)
2. Material (Steel / Stainless / ABS)
3. Cross-section Surface (U-shape / Round / Straight)
4. Grade (Yes / No) *See below
5. Reflective (Yes / No)
6. Size (Width / Length / Thickness)

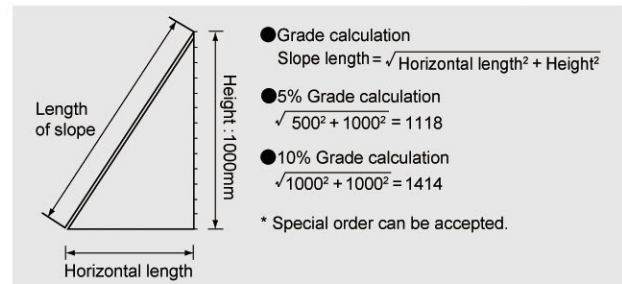

PRODUCT NAME	MODEL	PKG QTY	MOQ	CODE NO.	C/O
Stream Gauge	Standard	-	-	102246	JP
Stream Gauge	Chuden	-	-	102254	JP
Stream Gauge	AKK	-	-	102255	JP

Water Level Meter

RWL series

THIN PROBE

Suitable for small and narrow hole, because of thin probe.



RWL-10M



RWL-100M

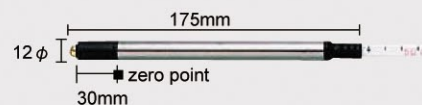

► FEATURES

- Quick measuring
- Thin probe can be used at small hole
- Self disconnection checking function
- Notify by buzzer when probe soak at 3cm in the water
- Sensitivity adjustable

► SPECIFICATIONS

Model	RWL-10M	RWL-50M	RWL-100M
Length	10m	50m	100m
Tape size	6.20 x 2.0mm	6.20 x 2.0mm	6.20 x 2.0mm
Graduation	10mm interval	10mm interval	10mm interval
Probe	12 φ x 175mm	12 φ x 175mm	12 φ x 175mm
Weight	730g	2,000g	3,100g
Dimension	219 x 156 x 56mm	333 x 220 x 133mm	333 x 220 x 193mm
Power	AA battery x 2pcs	AA battery x 2pcs	AA battery x 2pcs

PRODUCT NAME	MODEL	PKG QTY	MOQ	CODE NO.	C/O
Water Level Meter 10M	RWL-10M	1	1	216284	JP
Water Level Meter 50M	RWL-50M	1	1	212108	JP
Water Level Meter 100M	RWL-100M	1	1	212109	JP



TESTING INSTRUMENT

- Thermometer P124
- Thermo-Hyrometer P126
- Environment Meter P127
- Barometer / Altimeter P128
- Anemometer P129
- Moisture Meter / Current Meter / Coating Thickness Gauge P130
- Clamp Meter / Sound Meter / pH Meter P131
- Test Hammer / Test Anvil P132
- Rock Hammer P133
- Slump Test / Screen / Air Meter P134
- Crack Scale P135
- Soil Moisture Meter / Inspection Hammer / Scale / Magnifier P136



TRIPOD 1
PRISM 2
POLE 3
STAFF 4
GNSS ACCESSORY 5
SURVEYING / LASER INSTRUMENT 6
SURVEYING ACCESSORY 7
MEASURING TOOL 8
TESTING INSTRUMENT 9
SECURITY GOODS 10

Introduction

Temperature Control

When paving a road with asphalt, the control of asphalt temperature is quite important. Decreasing the temperature of asphalt paving mixture brings demanding work. In Japan, the following temperature is recommended in paving.

Control Point	Temperature
Asphalt paving mixture	under 185°C
Spreading of concrete	over 110°C
1st rolling	110~140°C
2nd rolling	70~90°C

If not keeping conditions, the quality of concrete should be poor and the life will be short. To control the temperature, we recommend using of the thermometer.



Digital Waterproof Thermometer

SK-1260

VARIOUS SENSOR PROBES

Various sensor probes are available for wide variety of applications.



SK-1260



Measuring concrete temperature (SK-1260 with soft pouch)

SK-S100K

Standard sensor probe
-100~300°C
φ 2.3 x 150mm



SK-S103K

Asphalt sensor probe with accurate tip
Stainless made
0~300°C
φ 5 x 250mm



SK-S106K

Asphalt sensor probe with accurate tip
Resin handle
0~300°C
φ 5 x 251mm



► FEATURES

- Measurement values can be stored into memory with a simple operation.
- Various optional probes are available for a wide variety of applications.
- A large LCD with multi-display

► STANDARD ACCESSORIES

- Soft pouch with neck strap
- AAA manganese batteries x 4

► SPECIFICATIONS

Measuring range : -99.9 ~ 1,250°C
Resolution : 0.1°C at -30 ~ 199.9°C
: 1°C at 200 ~ 1,250°C
Accuracy : ±(0.1%rdg + 0.3)°C at 0 ~ 199.9°C
: ±0.5°C at -99.9 ~ -0.1°C
: ±(0.2%rdg + 1)°C at 200 ~ 1,250°C

Operational functions

Max : Maximum memory data
Min : Minimum memory data
Hold : Data hold
Rel : Measurement of variation
Time : Time setting
Rec / Print : Record & print (if have printer)
Alarm : Upper & lower limit
Water proof property : IPX4
Power : AAA batteries x 4 or AC adapter (option)
Battery life : 280 hours with alkaline batteries
Dimensions : W66 x H175 x D25mm
Weight : approx. 200g (Main unit with batteries)

PRODUCT NAME	MODEL	PKG QTY	MOQ	CODE NO.	C/O
Thermometer	SK-1260	1	1	218850	JP
Sensor Probe -100~300°C	SK-S100K	1	1	219087	JP
Sensor Probe 0~300°C	SK-S103K	1	1	218853	JP
Sensor Probe 0~300°C	SK-S106K	1	1	218854	JP

Thermometer for Asphalt

AT series

PLATED SMALL SCALE

AT series is plated small scale of thermometer for asphalt.



AT-80



AT-100



AT-150



AT-80K



AT-100K



AT-150K

PRODUCT NAME	MODEL	PKG QTY	MOQ	CODE NO.	C/O
Thermometer / White / 80mm φ	AT-80	1	5	082921	JP
Thermometer / White / 100mm φ	AT-100	1	5	082922	JP
Thermometer / White / 150mm φ	AT-150	1	5	082923	JP
Thermometer / Black / 80mm φ	AT-80K	1	5	211745	JP
Thermometer / Black / 100mm φ	AT-100K	1	5	211746	JP
Thermometer / Black / 150mm φ	AT-150K	1	5	211747	JP

► SPECIFICATIONS

Model	AT-80	AT-100	AT-150
Measuring range	0 ~ 200°C	0 ~ 200°C	0 ~ 200°C
Dimension	80mm φ	100mm φ	150mm φ
Color	White	White	White
Material	Stainless (SUS304)	Stainless (SUS304)	Stainless (SUS304)

Model	AT-80K	AT-100K	AT-150K
Measuring range	0 ~ 200°C	0 ~ 200°C	0 ~ 200°C
Dimension	80mm φ	100mm φ	150mm φ
Color	Black	Black	Black
Material	Stainless (SUS304)	Stainless (SUS304)	Stainless (SUS304)

Infrared Radiation Thermometer

SK-8700 II

BEST SELLER

The laser marker points the target for easy measurements.



► SPECIFICATIONS

Measuring range	: -20 ~ 420°C (0 ~ 786°F)
Accuracy	: ± 2°C (-20 ~ 100°C)
	: ± 2% (101 ~ 420°C)
Resolution	: 1°C / 1°F
Output power	: Class II laser (less than 1mW of power)
Storage temperature	: -20 ~ 55°C, below 90%RH (no condensation)
Power	: 9V battery x 1
Dimensions	: W41.5 x D65 x H160mm
Weight	: approx. 140g (with battery)

► STANDARD ACCESSORIES

- Protection cover
- Strap

PRODUCT NAME	MODEL	PKG QTY	MOQ	CODE NO.	C/O
Infrared Radiation Thermometer	SK-8700 II	1	2	213330	CN

Infrared Radiation Thermometer

IR-01U

DOUBLE MEASUREMENT

Infrared and Air temperature can be measured at the same time.



► SPECIFICATIONS

Measuring range	: -10 ~ 60°C for environment, -30 ~ 550°C for radiation
Resolution	: 0.1°C for environment and radiation
Accuracy	: ± 0.5°C for environment, ± 2°C (-30 ~ 100°C) for radiation ± 2%rdg (any other) for radiation
Sampling	: 2 times / sec.
Operating temperature	: 0 ~ 50°C, below 70%RH (no condensation)
Storage temperature	: -20 ~ 60°C, below 80%RH (no condensation)
Power	: AAA battery x 2
Dimensions	: W50 x H116.6 x D20.6mm
Weight	: approx. 128g (incl. batteries & cover)

► STANDARD ACCESSORIES

- Protection cover
- Strap

PRODUCT NAME	MODEL	PKG QTY	MOQ	CODE NO.	C/O
Infrared Radiation Thermometer	IR-01U	1	2	219765	TW

Digital Max. and Min. Thermometer

PC-6800

2ch SENSOR

Display both indoor and outdoor temperature value at the same time.



SPECIFICATIONS

Measuring range : -50 ~ 70°C for external,
-5 ~ 50°C for internal sensor
Accuracy : ± 1°C (0 ~ 40°C)
± 2°C (other range)
Resolution : 0.1°C
Materials of case : ABS resin
Power : AAA battery x 1
Dimensions : W98 x H107 x D20mm
Weight : approx. 145g

STANDARD ACCESSORIES

- External sensor with 3m cable
- AAA battery x 1pc

PRODUCT NAME	MODEL	PKG QTY	MOQ	CODE NO.	C/O
Max. and Min. Thermometer	PC-6800	10	10	082899	CN

Digital Thermo Hygrometer

CTH-01U

MULTI-FUNCTION

Multi Function as thermometer and Hygrometer.



SPECIFICATIONS

Measuring range : 0 ~ 60°C for temperature, 5 ~ 95%RH for humidity
Resolution : 0.1°C for temperature, 0.1%RH for humidity
Accuracy
Temperature : ± 0.5°C (+10 ~ 45°C), ± 2°C (others)
Humidity : ± 2.5%RH (10 ~ 90%RH), ± 5%RH (any other)
Operating temperature : -20 ~ 60°C, below 80%RH (no condensation)
Storage temperature : 0 ~ 50°C, below 70%RH (no condensation)
Power : AAA battery x 2
Dimensions : W50 x H115.5 x D20.6mm
Weight : approx. 120g (incl. batteries & cover)

STANDARD ACCESSORIES

- Protection cover
- Strap

PRODUCT NAME	MODEL	PKG QTY	MOQ	CODE NO.	C/O
Thermo-Hygrometer	CTH-01U	1	2	219740	TW

Compact Thermometer

FG-5152



FEATURES

- Well working at cold place

SPECIFICATIONS

Measuring range : -50 ~ 50°C
Resolution : 1°C
Accuracy : ± 1°C (-20 ~ 40°C)
± 2°C (other range)
Dimension : W55 x H55 x D16mm
Weight : 25g

STANDARD ACCESSORIES

- Car attach holder

PRODUCT NAME	MODEL	PKG QTY	MOQ	CODE NO.	C/O
Compact Thermometer	FG-5152	1	10	219388	JP

Thermo-Hygrometer

PC-5000TRH-2



FEATURES

- Sensor probe model

SPECIFICATIONS

Measuring range
Temperature : 0 ~ 50°C (internal)
-50 ~ 70°C (external)
Humidity : 25 ~ 95%RH (internal)
Resolution : 1°C for temperature
1% for R. Humidity
Power : AAA battery x 1
Dimensions : W98 x H107 x D20mm

STANDARD ACCESSORIES

- External sensor with 3m cord

PRODUCT NAME	MODEL	PKG QTY	MOQ	CODE NO.	C/O
Thermo-Hygrometer	PC-5000TRH-2	10	10	210377	CN

Thermo-Hygrometer

HIGHEST2



FEATURES

- Using human hair for detecting humidity & a thermistor for temperature

SPECIFICATIONS

Measuring range
Temperature : 0 ~ 50°C
Humidity : 20 ~ 100%RH
Accuracy
Temperature : ± 1 (0 ~ 40°C)
± 2°C (other range)
Humidity : ± 4% (40 ~ 80%RH)
± 7% (other range)
Dimensions : 135 φ x 33 mm
Power : AA battery x 1

PRODUCT NAME	MODEL	PKG QTY	MOQ	CODE NO.	C/O
Thermo-Hygrometer	HIGHEST2	1	5	210625	JP

Thermo-Hygrometer

TH series



TH-300



TH-200

FEATURES

- Suitable for large room
- Simple and functional design

SPECIFICATIONS

Measuring range
Temperature : -30 ~ 50°C
Humidity : 20 ~ 100%RH
Accuracy
Temperature : ± 2°C
Humidity : ± 5% (15 ~ 25°C)
Dimensions : 285 x 285 x 35mm (TH-300)
180 x 180 x 35mm (TH-200)

PRODUCT NAME	MODEL	PKG QTY	MOQ	CODE NO.	C/O
Thermo-Hygrometer / 250mm φ	TH-300	10	10	216368	JP
Thermo-Hygrometer / 150mm φ	TH-200	10	10	216369	JP

Multifunction Environmental Meter

AHLT-100

FOUR IN ONE

AHLT-100 have 4 functions; Anemometer, Thermometer, Hygrometer, luminometer



- **FEATURES**
- Max. and Min. value recordable
 - Auto power off

► **SPECIFICATIONS**

Display	: 5 digits
Measuring range	
Thermocouple Thermometer	: -100 ~ +1,300°C
Thermo-Hygrometer	: 10 ~ 95%RH / 0 ~ +50°C
Anemometer	: 0.4 ~ 25.0m/s
Luminometer	: 0 ~ 20,000Lx
Power	: 006P (9V) x 1
Size	: W60 x H156 x D33mm
Weight	: approx. 160g

- **STANDARD ACCESSORIES**
- Manual
 - Strap

* The sensor probe for thermocouple thermometer is option.

PRODUCT NAME	MODEL	PKG QTY	MOQ	CODE NO.	C/O
Environmental Meter	AHLT-100	1	2	213229	TW

Multifunctional Environmental Meter

FG-561

COMPACT & HIGH FUNCTIONAL

It's compact with high function and simple operation.



- **FEATURES**
- Handheld
 - Slidable cover to protect the measuring parts
 - Simple operation by just 2 buttons

► **SPECIFICATIONS**

Wind Meter	
Measuring range	: 0 ~ 20m/s
Measuring method	: Thermistor
Resolution	: 0.2m/s (0 ~ 3m/s) 0.5m/s (4 ~ 20m/s)
Accuracy	: ± 5% + 0.2m/s (0 ~ 10m/s) ± 10% (10 ~ 20m/s)
Thermometer	
Measuring range	: 0 ~ 50°C
Measuring method	: Thermistor
Accuracy	: ± 1°C (0 ~ 40°C) ± 2°C (other range)
Power	: 006P (9V) x 1 or 2pcs
Size	: W56 x D36 x H160mm
Weight	: approx. 210g (incl. batteries)

PRODUCT NAME	MODEL	PKG QTY	MOQ	CODE NO.	C/O
Environmental Meter	FG-561	10	10	082855	JP

NEW Environmental Multimeter

LM-8102

5 IN 1 CONDITION METER

Measure the sound level, illuminance, wind speed, temperature and humidity only with this instrument.



- **FEATURES**
- Sound level meter meets IEC61672 class 2
 - Anemometer uses a low-friction ball bearing mounted wheel design for high accuracy
 - Type K thermocouple thermometer (Probe is optional)
 - Light meter uses a photo diode
 - Max. and Min. hold function

- **STANDARD ACCESSORIES**
- Windscreen for sound level mode
 - Case

► **SPECIFICATIONS**

	Measuring range	Resolution	Accuracy
Sound level	30 ~ 130dB	0.1dB	±1.4dB(1kHz/94dB)
Illuminance	0 ~ 20000Lux	1Lux	±0.5%rdg+8dgt
Wind speed	0.4 ~ 30.0m/s	0.1m/s	±3%F.S(≤20m/s)
Temperature	0 ~ 50°C	0.1°C	±2°C
Temperature(Thermocouple)	-100 ~ 1300°C	0.1°C	±2°C
Humidity	10 ~ 95%RH	0.1%RH	±4%RH(<70%RH)

Data output PS232C / USB
 Operating temperature 0 ~ 40°C, 10 ~ 85%RH
 Power AAA batteries x 4 / DC6V (AC adapter is optional)
 Dimensions W70 x H248 x D34mm
 Weight approx. 336g

PRODUCT NAME	MODEL	PKG QTY	MOQ	CODE NO.	C/O
Environmental Multimeter	LM-8102	1	1	219222	CN

Multifunction Altimeter

ADC Summit

VARIETY FUNCTION

ADC Summit can measure altitude, atmosphere, wind speed, temperature and so on.



- **FEATURES**
- Waterproof housing
 - Graphic LCD for info/graphs
 - Click on attachment
 - LCD Illumination
 - Clock, date, alarm
 - Weather Forecast
 - Data log memory (1984 readings)
 - Infrared communication with PC (to optional ADR IR)

► **SPECIFICATIONS**

Size	: H110 x W50 x D20mm
Weight	: approx. 50g (excl.battery)
Power	: CR2032 x 1
Altimeter	
Accuracy	: ±3m
Resolution	: 1m
Unit	: meter / feet
Barometer	
Accuracy	: ±1.5mb (700 ~ 1,100mb)
Resolution	: 0.1hPa
Unit	: hPa, mbar, inHg
Anemometer	
Accuracy	: ±10% (up to 3.0m/s) ±5% (over 3.0m/s)
Resolution	: 0.1m/s
Unit	: m/s, km/h, mph, knots, ft/s
Temperature	
Accuracy	: ±1°C
Resolution	: 0.1°C
Unit	: Celsius, Fahrenheit

- **STANDARD ACCESSORIES**
- Manual
 - Strap
 - Battery

PRODUCT NAME	MODEL	PKG QTY	MOQ	CODE NO.	C/O
Multifunction Altimeter	ADC SUMMIT	1	1	-	CN

TRIPOD 1
 PRISM 2
 POLE 3
 STAFF 4
 GNSS ACCESSORY 5
 SURVEYING / LASER INSTRUMENT 6
 SURVEYING ACCESSORY 7
 MEASURING TOOL 8
 TESTING INSTRUMENT 9
 SECURITY GOODS 10

Barometer

BAROMEX 7612

HANGING WALL

Big display and good for hanging on a wall.



▶ FEATURES

- The index pointer enables you to see changes in atmospheric pressure.

▶ SPECIFICATIONS

Measuring range

Torr : 710 ~ 780mmHg

Hectopascal : 945 ~ 1,045hPa

Temperature : 0 ~ 50°C

Accuracy

Barometer : ± 1hPa (980 ~ 1,020hPa), ± 3hPa (other range)

Thermometer : ± 0.1°C (0 ~ 40°C)

Dimensions : 135 φ x 33 mm

Power : AA battery x 1

Weight : 0.25kg

PRODUCT NAME	MODEL	PKG QTY	MOQ	CODE NO.	C/O
Barometer	BAROMEX 7612	1	2	082750	JP



Barometer

BA-654

COMPACT & HIGH FUNCTIONAL

Pressure tendency can forecast short term changes in the weather.



▶ FEATURES

- Set gold needle at black needle (atmospheric pressure), and read how much black needle moved to the right(high) or left(low)
- Made in Japan

▶ SPECIFICATIONS

Measuring range : 950 ~ 1050hpa

Resolution : 2hps

Accuracy : ± 2hpa

Dimensions : 130 φ x 40mm

Weight : approx. 260g

PRODUCT NAME	MODEL	PKG QTY	MOQ	CODE NO.	C/O
Barometer	BA-654	1	2	221190	JP

Barometric Altimeter with Compass

630

SHOCK-PROOF

It's shock-proof by oil compass.



▶ FEATURES

- Barometer, Altimeter, Compass, Thermometer
- Wearing around own neck
- Good for outdoor activity such as hiking

▶ SPECIFICATIONS

Altimeter : 0 ~ 5,000m

Barometer : 620 ~ 1,040hpa

Thermometer : -20 ~ 50°C

Size : 85 x 70 x 28mm

Weight : approx. 82g

▶ STANDARD ACCESSORIES

- Strap
- Thermometer
- Compass

PRODUCT NAME	MODEL	PKG QTY	MOQ	CODE NO.	C/O
Barometric Altimeter	630	1	10	221188	CN

Compact Altimeter

FG-5102



✓ CHECK

HOLDER

FG-5102 includes the holder of FG-5102. The holder has adhesive tape. You can mount on the car, wall, and so on.



▶ FEATURES

Compact and tiny altimeter

▶ STANDARD ACCESSORIES

- Car attached holder

▶ SPECIFICATIONS

Measuring range

Altitude : 0 ~ 4,500m

Air pressure: 580 ~ 1,040hPa

Accuracy : ± 20m / ± 5%

Resolution : 50m / 5hPa

Dimensions : H66 x W68 x D25mm

Weight : 65g

PRODUCT NAME	MODEL	PKG QTY	MOQ	CODE NO.	C/O
Compact Altimeter	FG-5102	1	5	219387	JP

NEW **Anemometer**
5020-0882

COMPACT MODEL

Simple operation with one button.



- **FEATURES**
- Display a maximum & minimum data
 - Various units available
 - Automatic back light
 - Battery indicator
 - Auto power off (approx. 15mins)
- **SPECIFICATIONS**
- Measuring range : 0.4 ~ 25.00m/s
 Resolution : 0.01m/s
 Accuracy : ± (3%+0.30m/s)
 Units : m/s, kph, fpm, mph, knt
 Power : 006P x 1
 Dimensions : H165 x W54 x D34mm
 Weight : approx. 180g
- **STANDARD ACCESSORIES**
- Case

PRODUCT NAME	MODEL	PKG QTY	MOQ	CODE NO.	C/O
Anemometer	5020-0882	1	2	220474	CN

NEW **Multifunction Anemometer**
ADC-WIND

WIND GAUGE WITH CLEVER FUNCTIONS

The perfect instrument made for those who are dependent on the wind conditions in their work.



- **FEATURES**
- Wind speed, temperature, current time, daily alarm, chronograph and race timer functions
 - Beaufort scale
 - Current, max and average wind speed
 - Wind speed alarm and time span for average wind speed calculation changeable
 - Propeller as a mechanical compass
 - Current temperature, current and minimum wind chill temperature, and temperature history graph (last 24 hours)
 - Wind chill temperature alarm
 - Back light (3 seconds)
 - Waterproof IPX7
- **STANDARD ACCESSORIES**
- Detachable belt clip

► **SPECIFICATIONS**

	Wind speed	Temperature
Measuring range	0.3 ~ 40.00m/s	-20 ~ +40°C
Resolution	0.1m/s	0.1°C
Accuracy	±5%(over 3.0m/s), ±10%(up to 3.0m/s)	±1°C
Units	m/s, km/h, mph, knots, ft/s	°C, °F
Dimensions	H109 x W50 x D20mm	
Weight	approx. 50g	

PRODUCT NAME	MODEL	PKG QTY	MOQ	CODE NO.	C/O
Anemometer	ADC-WIND	1	2	221753	CN

Anemometer & Air Flow Meter

WS-01

3 FUNCTIONS

WS-01 can measure wind speed, air flow and temperature.



- **FEATURES**
- Able to measure wind speed, air flow & temperature by one instrument
 - The memory can be stored up to 10 measurement values
 - Auto power off function is available (can be deactivated)
 - Hold function is also available
 - Display a maximum & minimum measurement of wind speed & temperature
 - Average temperature can be displayed

- **SPECIFICATIONS**
- Display : LCD dual display
 Measuring function : Wind speed, air flow & temperature
 Sensor : Vane type
- Measuring range
 Wind speed : 0.5 ~ 25m/s
 Temperature : 0 ~ 50°C
 Resolution : 0.1°C, 0.1m/s
 Accuracy
 Wind speed : ± 3%rdg or ± 0.8m/s (bigger one)
 Temperature : ± 0.5°C
 Operating temperature : 0 ~ 50°C, below 80%RH (no condensation)
 Storage temperature : -10 ~ 50°C, below 75%RH (no condensation)
 Power : AAA alkaline battery x 3
 Dimensions
 Body : W85 x H168 x D38mm
 Sensor : W77 x H168 x D33mm
 Propeller : 65mm φ
 Weight : approx. 323g
 Cable length : 1m

PRODUCT NAME	MODEL	PKG QTY	MOQ	CODE NO.	C/O
Anemometer & Air Flow Meter	WS-01	1	2	217273	CN

Anemometer

PC-52D

EXTRA COMPACT

It's easy and quick to measure.



- **FEATURES**
- Just 2 buttons to measure
 - Extra compact 54g
 - Various measuring units
- **SPECIFICATIONS**
- Wind meter
 Measuring range : 1.1 ~ 15.0m/s
 Accuracy : ± 1.1 (1.1 ~ 10.0m/s)
 ± 2.0m/s (other range)
 Measuring method : Propeller
- Thermometer
 Measuring range : 0.0 ~ 50.0°C
 Accuracy : ±1.0°C
 Measuring method : Thermistor
- Material : ABS
 Power : CR2032 x 1
 Size : W44 x H130 x D16mm
 Weight : approx. 54g (incl. battery)

PRODUCT NAME	MODEL	PKG QTY	MOQ	CODE NO.	C/O
Anemometer	PC-52D	1	2	218636	CN

TRIPOD 1
 PRISM 2
 POLE 3
 STAFF 4
 GNSS ACCESSORY 5
 SURVEYING / LASER INSTRUMENT 6
 SURVEYING ACCESSORY 7
 MEASURING TOOL 8
 TESTING INSTRUMENT 9
 SECURITY GOODS 10

NEW Moisture Meter HT-20

WOOD AND BUILDING MATERIALS
Designed for fast and convenient moisture measurements.



- **FEATURES**
- Non-damaging material's surface
 - Auto power off (1min.)
 - Back light
 - Battery indicator
- **STANDARD ACCESSORIES**
- Manual
 - Strap
 - Case



- **SPECIFICATIONS**
- Scanning depth : (wood) 20mm (concrete) 10mm
 Density range : (wood) 8 groups 420 ~ 700kg/m³
 : (concrete) 4 groups 1800 ~ 2400kg/m³
 Resolution : 0.1% humidity; 1°C / °F
 Measuring range : (wood) 2.0 ~ 65.0% (concrete) 0 ~ 35.0%
 Temperature range : -10 ~ 60°C
 Operating temperature : 0 ~ 40°C
 Power : AAA batteries x 2
 Dimensions : H110 x W43 x D25mm
 Weight : 75g

PRODUCT NAME	MODEL	PKG QTY	MOQ	CODE NO.	C/O
Moisture Meter	HT-20	1	2	220449	CN

Digital Moisture Meter MM-01U

MATERIAL SELECTION

Useful 7 material selection set up. (2 wood group / 5 mortar group)



Back light



Protection cover

- **SPECIFICATIONS**
- Measuring range : 8.8 ~ 54.8% (fagaceae, spruce, larch, birch, cherry, walnut)
 7.0 ~ 47.9% (oak, pine, maple, Norway spruce)
 0.9 ~ 22.1% (cement, concrete, concrete plaster)
 0.0 ~ 11.0% (plaster), 0.7 ~ 8.6% (cement mortar)
 0.6 ~ 9.9% (coal mortar), 0.1 ~ 16.5% (brick)
- Operating temperature : 0 ~ 50°C, below 70%RH (no condensation)
 Storage temperature : -20 ~ 60°C, below 80%RH (no condensation)
 Power : AAA battery x 2pcs
 Dimensions : W50 x H119 x D20.6mm
 Weight : approx. 119g (incl. batteries & cover)

- **STANDARD ACCESSORIES**
- Protection cover
 - Strap

PRODUCT NAME	MODEL	PKG QTY	MOQ	CODE NO.	C/O
Digital Moisture Meter	MM-01U	1	2	219794	TW

Current Meter ROPE STYLE



- **FEATURES**
- Measuring water flow by cup wheel
- **SPECIFICATIONS**
- Measuring range : 0.20 ~ 1.70 m/s
 Min. depth : 300mm
 Size : 394 x 114 x 126mm
 Weight : 1.16kg
- **STANDARD ACCESSORIES**
- 2 core cable 7m (50cm graduation)
 - Buzzer
 - Weight 5kg

PRODUCT NAME	MODEL	PKG QTY	MOQ	CODE NO.	C/O
Current Meter / Rope Style	Rope style	1	1	082765	JP

Current Meter Hiroi Style



- **FEATURES**
- Measuring water flow by propeller
- **SPECIFICATIONS**
- Measuring range : 0.15 ~ 2.00m/s
 Min. depth : 50mm
 Size : 410 x 100 x 90mm
 Weight : 1.24kg
- **STANDARD ACCESSORIES**
- Rod 1m x 3
 - Cord 3m

PRODUCT NAME	MODEL	PKG QTY	MOQ	CODE NO.	C/O
Current Meter / Hiroi Style	HIROI STYLE	1	1	221320	JP

NEW Coating Thickness Gauge TG-01U / TG-02U

COMPACT & RIGHT

It's compact with high function and simple operation.



- **FEATURES**
- 2 types of self-calibration
 - Max. / Min. alarm function
 - Auto power off (30sec.)
 - Back light
 - Battery indicator

- **STANDARD ACCESSORIES**
- Coating plate
 - Calibration plate
 - Case
 - Strap



Display automatically rotates for ease of use

- **SPECIFICATIONS**
- Measuring method : (ferrous) magnetic (non-ferrous) eddy-current
 Measuring range : (ferrous) 0 ~ 2,000µm (non-ferrous) 0 ~ 1,000µm
 Resolution : 1µm
 Power : AAA batteries x 2
 Dimensions : W55 x H105 x D27mm
 Weight : approx. 85g (incl. batteries)

PRODUCT NAME	MODEL	PKG QTY	MOQ	CODE NO.	C/O
Ferrous	TG-01U	1	2	220615	TW
Ferrous and Non-ferrous	TG-02U	1	2	220616	TW

NEW Flexible Clamp Meter

CFL-02U

CLAMP METER WITH TESTER FUNCTION

Easy measurement in narrow place with flexible clamp sensor coil.



- **FEATURES**
- ACA / ACV / DCV / Ω / Hz
 - TRUE RMS
 - 2 line display - ACA & Hz
 - Back light and LED light for dark place
 - Auto power off (5mins.)
 - Data hold function
 - EN61010-1, EN61010-2-032, EN61326-1, CAT III 1000V, CATIV 600V

- **STANDARD ACCESSORIES**
- 1 set of measuring cables
 - Case



- **SPECIFICATIONS**
- Measuring range : 0.2 ~ 3000A / 0.2 ~ 600V / 0 ~ 6MΩ / 40 ~ 10kHz
 - Measurable conductor : Max. 120mm φ
 - Clamp sensor coil : 45cm x 7.5mm φ
 - Power : AAA batteries x 3
 - Dimensions : W178 x H324 x D30mm
 - Weight : approx. 198g

PRODUCT NAME	MODEL	PKG QTY	MOQ	CODE NO.	C/O
Flexible Clamp Meter	CFL-02U	1	2	222071	CN

Digital Sound Level Meter

MT-325

SIMPLE OPERATION

MT-325 is our entry model sound level meter.



- **FEATURES**
- Compact size
 - Max. / Min. function
 - Level range display
 - IEC 651 type 2

- **SPECIFICATIONS**
- Level range : Lo 30 ~ 80dB
Me 50 ~ 100dB
Hi 80 ~ 130dB
 - Accuracy : ±1.5dB
 - Resolution : 0.1dB
 - Frequency weighting : A / C
 - Dynamic range : 50dB
 - Frequency range : 31.5Hz ~ 8kHz
 - Power : 006P (9v) x 1
 - Operating time : approx. 60h
 - Size : H232 x W54 x D34mm
 - Weight : approx. 200g

- **STANDARD ACCESSORIES**
- Wind screen
 - Calibration screwdriver
 - Manual
 - Battery

PRODUCT NAME	MODEL	PKG QTY	MOQ	CODE NO.	C/O
Digital Sound Level Meter	MT-325	1	5	219088	TW

NEW PM2.5 Air Monitor

TH-A1 series

PM2.5 MEASURING INSTRUMENT

Measure the density of particle matter(PM2.5) to prevent health effects.



- **FEATURES**
- Easy-to-view LED display
 - Simple two-button operation
 - Three modes
NOW - Measurement in 8 seconds
HOUR - 1 hour average
DAY - 24 hours average
*HOUR&DAY mode: available only power is supplied via the USB port.



Color changes on display according to the level.

- **SPECIFICATIONS**
- Measuring principle: Light scattering method
 - Measuring range: 0 ~ 500µm / m³
 - Measuring time : 8 seconds
 - Accuracy : ±15%
 - Power : AA batteries x 2 or USB cable (not included)
 - Dimensions : W62 x H123 x D47mm
 - Weight : 200g



PRODUCT NAME	MODEL	PKG QTY	MOQ	CODE NO.	C/O
PM2.5 Air Monitor / White	TH-A1 (W)	1	2	221459	JP
PM2.5 Air Monitor / Red	TH-A1 (R)	1	2	221460	JP
PM2.5 Air Monitor / Gold	TH-A1 (G)	1	2	221461	JP

Pocket pH Meter

SK-630PH / SK-631PH

pH & WATER TEMPERATURE

pH & Water temperature is measurable at the same time.



- **STANDARD ACCESSORIES**
- LR44 Alkaline battery x 4

- **SPECIFICATIONS**
- | Model | SK-630PH | SK-631PH |
|-----------------------|--------------------------------|--------------------------------|
| Measuring range | | |
| pH | 2.00 ~ 12.00pH | 2.00 ~ 12.00pH |
| Temperature | 0 ~ 50°C | - |
| Accuracy | | |
| pH | ± 0.5pH | ± 0.6pH |
| Temperature | ± 1.0°C | - |
| Resolution | | |
| pH | ± 0.1pH | ± 0.1pH |
| Temperature | ± 0.5°C | - |
| Operating temperature | 0 ~ 50°C, below 60%RH | 0 ~ 50°C, below 60%RH |
| Elements | Glass electrode / Thermistor | Glass electrode |
| Power | Alkaline batteries LR44 x 4pcs | Alkaline batteries LR44 x 4pcs |
| Battery life | 20 hours | 20 hours |
| Dimensions | W36 x H150 x D25mm | W36 x H150 x D25mm |
| Weight | 65g (inclusive of batteries) | 65g (inclusive of batteries) |

PRODUCT NAME	MODEL	PKG QTY	MOQ	CODE NO.	C/O
Pocket pH Meter	SK-630PH	1	2	216316	CN
Pocket pH Meter	SK-631PH	1	2	216317	CN

Concrete Test Hammer

D-7000

LCD DIGITAL DISPLAY

The measuring value can be checked by LCD digital display.



▶ FEATURES

- Able to indicate the impact number, rebound number & average value
- Able to read above numbers & value in one lot after all measurements

▶ SPECIFICATIONS

Method : Repulsion hardness method
 Impact energy : 2.207N.m
 Measuring range : Cylinders, 10.0 ~ 70.0N/mm²
 Indication mode : Digital indication
 Anvil standard value : 80 ± 2
 Dimensions & weight : W103 x H109 x L355mm, 1.6kg
 Operating temperature : 0 ~ 40°C (storage temp. : -20 ~ 60°C)
 Power : AA battery x 4

▶ STANDARD ACCESSORIES

- Carborundum rubbing stone
- Batteries
- Carrying case

PRODUCT NAME	MODEL	PKG QTY	MOQ	CODE NO.	C/O
Concrete Test Hammer	D-7000	1	1	215539	JP

Concrete Test Hammer

R-7500

PRINTER

You don't need writing to record.



▶ FEATURES

- Displaying the rebound number in double digital figures & angle in the LCD display
- Can be printed the testing value on the scene

▶ SPECIFICATIONS

Method : Repulsion hardness method
 Impact energy : 2.207N.m
 Measuring range : Cylinders, 10.0 ~ 70.0N/mm²
 Indication mode : Digital indication (Thermal printing for recording)
 Anvil standard value : 80 ± 2
 Dimensions & weight : W103 x H109 x L355mm, 1.8kg
 Operating temperature : 0 ~ 40°C (storage temperature: -20 ~ 60°C)
 Power : AA battery x 4

▶ STANDARD ACCESSORIES

- Carborundum rubbing stone
- Batteries
- Carrying case
- Thermal recording paper

PRODUCT NAME	MODEL	PKG QTY	MOQ	CODE NO.	C/O
Concrete Test Hammer	R-7500	1	1	215538	JP

Concrete Test Hammer

N-6500

GRADUATION READING

Simple function, but high accurate and durability.



▶ FEATURES

- Provided with heat-treatment, hard-chrome plating & polishing to further increase its precision & durability

▶ SPECIFICATIONS

Method : Repulsion hardness method
 Impact energy : 2.207N.m
 Measuring range : Cylinders, 10.0 ~ 70.0N/mm²
 Indication mode : Scale indication
 Anvil standard value : 80 ± 2
 Dimensions & weight : W55 x H55 x L355mm, 1.0kg

▶ STANDARD ACCESSORIES

- Carborundum rubbing stone
- Carrying case

PRODUCT NAME	MODEL	PKG QTY	MOQ	CODE NO.	C/O
Concrete Test Hammer	N-6500	1	1	215442	JP

Test Anvil

KH-80

KEEP ACCURACY

Test Anvil is quite important to have a professional work.



▶ FEATURES

- Able to check whether the rebound value is within "80 ± 2" & less on the spot

▶ SPECIFICATIONS

Type : Standard type anvil
 Rebound value : 80 ± 2
 Rockwell hardness : more than HRC 56
 Dimensions : 146 φ x 228mm
 Weight : 17kg

▶ STANDARD ACCESSORIES

- Steel case

PRODUCT NAME	MODEL	PKG QTY	MOQ	CODE NO.	C/O
Test Anvil	KH-80	1	1	217204	JP

Concrete Test Hammer with Test Anvil

NS-III / NSR-III

COMPACT & LIGHTWEIGHT

These products include compact test hammer and anvil.



NS-III



NSR-III

► SPECIFICATIONS

Model	NS-III	NSR-III
Measuring range	10 ~ 70N/m ³	10 ~ 70N/m ³
Weight	4.0kg	4.3kg
Display	Graduation	Autographic recording

► STANDARD ACCESSORIES

- Test anvil 1kg (CA-III)
- Grinding stone
- Chalk
- Recording paper *NSR-III only
- Manual

PRODUCT NAME	MODEL	PKG QTY	MOQ	CODE NO.	C/O
Concrete Test Hammer / Graduation	NS-III	1	1	214018	JP
Concrete Test Hammer / Autographic	NSR-III	1	1	214295	JP

Concrete Test Hammer

NS / NS-2

STANDARD & ECONOMIC

This is the best loved model.



NS



NS-2

► SPECIFICATIONS

Model	NS	NS-2
Measuring range	10 ~ 70N/m ³	10 ~ 70N/m ³
Weight	3.0kg	5.2kg
Display	Graduation	Graduation

► STANDARD ACCESSORIES

- Test anvil 2.2kg *NS-2 only
- Grinding stone
- Chalk
- Manual

PRODUCT NAME	MODEL	PKG QTY	MOQ	CODE NO.	C/O
Concrete Test Hammer	NS	1	1	212791	JP
Concrete Test Hammer with test anvil	NS-2	1	1	212792	JP

Rock Hammer

GS-2 / GSR-2

GEOLOGICAL SURVEY

This is used for public works.



GS-2



GSR-2

► SPECIFICATIONS

Model	GS-2	GSR-2
Measuring range	5 ~ 496N/m ³	5 ~ 496N/m ³
Weight	5.2kg	5.5kg
Display	Graduation	Autographic recording

► STANDARD ACCESSORIES

- Test anvil 2.2kg
- Grinding stone
- Chalk
- Recording paper *GSR-2 only
- Manual

PRODUCT NAME	MODEL	PKG QTY	MOQ	CODE NO.	C/O
Rock Hammer / Graduation	GS-2	1	1	212796	JP
Rock Hammer / Autographic	GSR-2	1	1	212799	JP

Test Anvil

TEST ANVIL

KEEP ACCURACY

Test Anvil is quite important to have a professional work.



CA(RA)



CA-2(RA-2)

► DESCRIPTION

- CA/RA
Inspection for high value
- LA/RL
Inspection for low value
- CR
for both Rock & Concrete Hammer
- CA-2/RA-2
Lightweight 2.2kg

► SPECIFICATIONS

Model	CA	LA	CR	CA-2
Reference value	80R	43R	80R	63R
Weight	12.6kg	12.6kg	12.6kg	2.2kg

Model	RA	RL	CR	RA-2
Reference value	84R	33R	84R	60R
Weight	12.6kg	12.6kg	12.6kg	2.2kg

► STANDARD ACCESSORIES

- Carrying case (except for CA-2/RA-2)

PRODUCT NAME	MODEL	PKG QTY	MOQ	CODE NO.	C/O
Test Anvil / Concrete / 80R	CA	1	1	212801	JP
Test Anvil / Concrete / 43R	LA	1	1	216391	JP
Test Anvil / Concrete & Rock	CR	1	1	216393	JP
Test Anvil / Concrete / 63R	CA-2	1	1	213680	JP
Test Anvil / Rock / 84R	RA	1	1	212804	JP
Test Anvil / Concrete / 33R	RL	1	1	216392	JP
Test Anvil / Concrete / 60R	RA-2	1	1	213681	JP

Slump Test Apparatus

KC-126

CHECK HARDNESS

To know the quality of concrete leads the quality work.



KC-126



SL-SS



KC-128

► FEATURES

- Concrete slump testing instrument
- To measure the workability of fresh concrete

► SPECIFICATIONS

Slump cone : Top 100mm ϕ , Bottom 200mm ϕ , Height 300mm
 Tamping rod : 16 ϕ x L 550mm
 Base plate : 600 x 600 x 3.2mm

► CONTENTS(KC-126)

- Slump cone
- Measuring rod
- Tamping rod
- Base plate
- Round shovel

PRODUCT NAME	MODEL	PKG QTY	MOQ	CODE NO.	C/O
Slump Test Apparatus	KC-126	-	1	211016	JP
Staff with base	SL-SS	-	1	210860	JP
Funnel	KC-128	-	1	211767	JP

Screen for Concrete

SS-C-450

► FEATURES

- 7 types for fine aggregate
- 10 types for coarse aggregate

► SPECIFICATIONS

Nominal size
 Fine : 75, 150, 300, 600 (micro)
 1.18, 2.36, 4.75 (mm)
 Coarse : 9.5, 16.0, 19.0, 26.5,
 31.5, 37.5, 53.0, 63.0,
 75.0, 106.0 (mm)

► REMARKS

- 17 types of screens



PRODUCT NAME	MODEL	PKG QTY	MOQ	CODE NO.	C/O
Screen for Concrete / 200mm ϕ	SS-C-450	1	1	082508	JP

Screen for Asphalt

SS-A-182

► FEATURES

- 7 types for fine aggregate
- 11 types for coarse aggregate

► SPECIFICATIONS

Nominal size
 Fine : 75, 150, 300, 425 (micro)
 1.18, 2.36, 4.75 (mm)
 Coarse : 4.75, 9.5, 13.2, 19.0,
 26.5, 31.5, 37.5, 53.0,
 63.0, 75.0, 90.0 (mm)

► REMARKS

- 18 types of screens



PRODUCT NAME	MODEL	PKG QTY	MOQ	CODE NO.	C/O
Screen for Asphalt / 200mm ϕ	SS-A-182	1	1	082793	JP

Air Meter

KC-173

HIGH USABILITY

Injection cock uses ball valve.



PRODUCT NAME	MODEL	PKG QTY	MOQ	CODE NO.	C/O
Air Meter	KC-173	1	1	216592	JP



► FEATURES

- Lighter than conventional product; 6,600g
- Easy cleaning by removing the ribs on cover.
- Bellows style smooths the moving of indication.

► SPECIFICATIONS

Volume : 7 ℓ
 Measuring range : 0 ~ 10% (Water injection / Non water injection)
 Size : 320 x 320 x 513mm
 Weight : approx. 6,600g

► STANDARD ACCESSORIES

- Prod 16 x 550mm
- Measuring cylinder 100ml
- Scale 25 x 300mm
- Dropper
- Wooden Hammer
- Calibration pipe

Crack Scale

CRKS series

TAKE ONE LOOK

Simple check to know the building condition

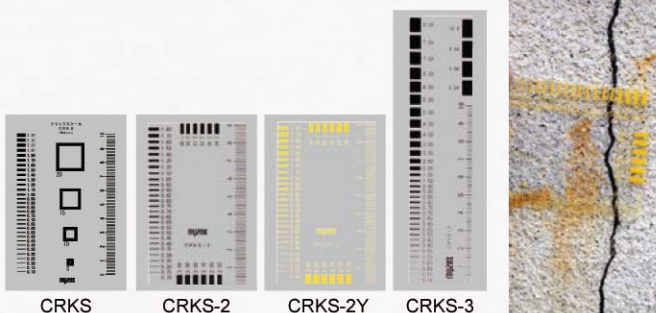

▶ FEATURES

- Easy to measure a crack of concrete accurately
- Compact size
- Enable to measure up to 10mm crack (CRKS-3)

▶ SPECIFICATIONS

MODEL	CRKS	CRKS-2	CRKS-2Y	CRKS-3
Dimensions	70 x 120mm	55 x 91mm	55 x 91mm	35 x 150mm
Measuring range	0.04 ~ 2.20	0.10 ~ 3.0	0.10 ~ 3.0	0.10 ~ 10.0
Graduation color	Black	Black	Yellow	Black

▶ REMARKS

- Semi-transparent (CRKS)
- Transparent (CRKS-2 / CRKS-2Y / CRKS-3)

PRODUCT NAME	MODEL	PKG QTY	MOQ	CODE NO.	C/O
Crack Scale	CRKS	1	20	082801	JP
Crack Scale	CRKS-2	1	20	219270	JP
Crack Scale	CRKS-2Y	1	20	219271	JP
Crack Scale	CRKS-3	1	20	219272	JP

Crack Gauge

CRACK GAUGE

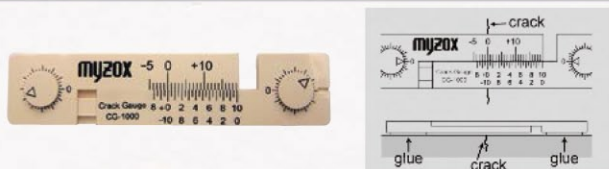

▶ SPECIFICATIONS

- Material : Acrylic resin
- Minimum scale : Main scale 1mm, Sub scale 0.05mm
- Measuring range : -5.0 ~ 5.7mm (resolution : 0.05mm)
-5.0 ~ 20mm (resolution : 1mm)
- Dimensions : 85 x 20 x 7mm

PRODUCT NAME	MODEL	PKG QTY	MOQ	CODE NO.	C/O
Crack Gauge / 5 pcs	CG-1000	1	20	220329	KR

Crack Disc

CRACK DISC



▶ FEATURES

- Easy measuring by glue sticking, and measure by caliper

▶ SPECIFICATIONS

- Material : Brass
- Dimensions : 7mm ϕ x 1.5mm

PRODUCT NAME	MODEL	PKG QTY	MOQ	CODE NO.	C/O
Crack Disc / 100 pcs	CD-100	1	10	220330	KR

Crack Depth Scale

CT-3

FOR DEPTH

Just insert can measure the depth.

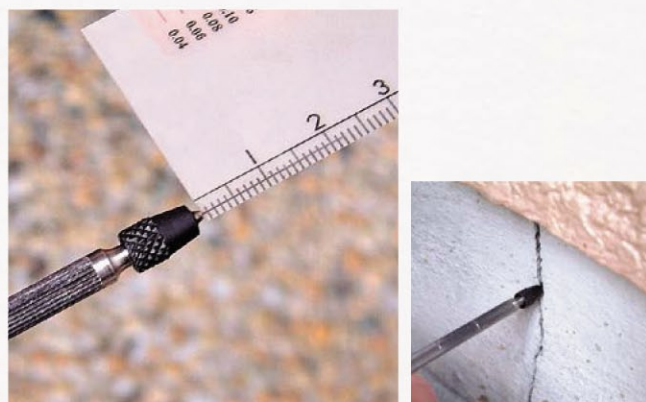

▶ FEATURES

- Useful for measuring depth and width of crack
- Compact size

▶ SPECIFICATIONS

- Gauge wire : 0.25 ϕ x 200mm x 10pcs
- Crack scale : Length up to 9cm
Width 0.04 ~ 1.4mm
- Wire holder : Screw type

▶ REMARKS

- Crack scale & gauge set

PRODUCT NAME	MODEL	PKG QTY	MOQ	CODE NO.	C/O
Crack Depth Scale	CT-3	1	5	212823	JP

Digital Crack Meter

CRACK-EYE

RESOLUTION 0.05mm

Quick measuring can improve your efficiency.



▶ FEATURES

- Quick to measure a crack width of concrete and metal
- Digital data display

How to use

1. Put the marking sheet on the crack.
2. Fit Crack-Eye in the white line of the marking sheet and push the button. Result will be displayed.
3. Marking sheet can be also used as a crack scale.

▶ SPECIFICATIONS

- Power : Rechargeable battery
- Dimensions : H100 x W70 x D25mm
- Weight : 105g

▶ STANDARD ACCESSORIES

- Battery charger
- Strap
- Marking sheet
- Spare parts set

PRODUCT NAME	MODEL	PKG QTY	MOQ	CODE NO.	C/O
Digital Crack Meter	CRACK-EYE	1	1	215445	JP

Soil Moisture Meter

SK-940A

MEASURING SOFT SOIL SAMPLE

Just touching the sample brings the accurate value.



▶ FEATURES

- Easy, just touching sample
- Quick measuring by one push

▶ SPECIFICATIONS

Measuring range : 12.1~58.0%
 Measuring temp. : 5 ~ 40°C
 Sensor type : for soft sample 25mm probe
 Power : 9V battery
 Size : W62 x H148 x D24mm
 Weight : approx. 145g (incl. battery)

PRODUCT NAME	MODEL	PKG QTY	MOQ	CODE NO.	C/O
Soil Moisture Meter	SK-940A Type4	1	1	221207	JP

Pick Hammer / Chisel Hammer

Inspection Hammer

3 TYPES

You can choose optimal one.

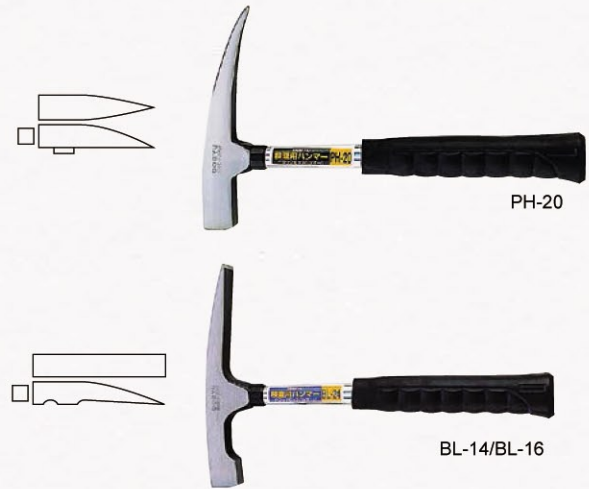

▶ SPECIFICATIONS

Model	PH-20	BL-14	BL-16
Overall	315mm	315mm	315mm
Head length	190mm	160mm	170mm
Hammer size	22 x 22mm	19 x 19mm	20 x 20mm
Weight	850g	580g	750g

PRODUCT NAME	MODEL	PKG QTY	MOQ	CODE NO.	C/O
Pick Hammer	PH-20	1	5	217813	JP
Chisel Hammer 160mm	BL-14	1	5	217814	JP
Chisel Hammer 170mm	BL-16	1	5	217815	JP

NEW Waterproof Mini Scale

MS-5000WP

3 COLORS DISPLAY

Display colors change at your preset value.

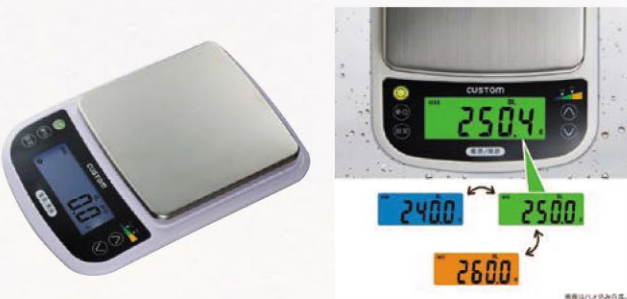

▶ FEATURES

- LED Backlight; colors change in check-weighing (blue - green - orange)
- Piece Counting / Tare function / IP-65
- Auto power off (5, 10, 20, 30, 40, 50, 60, 90mins or off)
- Circular level / Adjustable foot
- Stainless plate and plate cover are removable & washable

▶ SPECIFICATIONS

Capacity : 5000g
 Units : g, ml(water), ml(milk), piece *water: 1, milk: 1.03
 Resolution : 0.1g (0 ~ 1000g), 0.5g (1000.5 ~ 3000g), 1g (3001 ~ 5000g)
 Power : AA batteries x 2
 Dimensions : 141 x 48 x 206mm (Platform 120 x 126mm)
 Weight : approx. 430g (incl. batteries)

▶ STANDARD ACCESSORIES

- Stainless plate
- Plate cover / Tray

PRODUCT NAME	MODEL	PKG QTY	MOQ	CODE NO.	C/O
Waterproof Mini Scale	MS-5000WP	1	2	222018	CN

NEW Hand Magnifier

Iwamoto Loupe

JAPAN RELIABLE QUALITY

Once you have used Iwamoto loupe, you will not want to use any other.



▶ FEATURES

- Fully corrected for spherical and chromatic errors through a three glass lens optical system.
- Chrome plated frame with leather case

▶ SPECIFICATIONS

Model	IWAMOTO 10X	IWAMOTO 20X
Focal diameter	25mm	16mm
Focal length	22 ~ 30mm	10 ~ 12mm

PRODUCT NAME	MODEL	PKG QTY	MOQ	CODE NO.	C/O
Hand magnifier 10x	IWAMOTO 10X	10	10	221504	JP
Hand magnifier 20x	IWAMOTO 20X	10	10	221505	JP

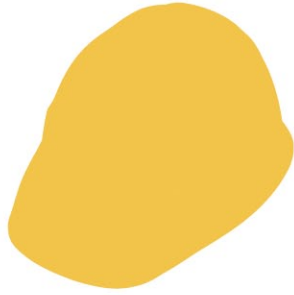

SECURITY GOODS



- Hard Hat P138
- Safety Vest P140
- Safety Belt P141
- Gloves / Glasses / Safety Shoes P142
- Working Wear / Head Light P143
- LED Torch / Inspection Camera P144
- Safety Cone / Barricade Tape P145



SECURITY GOODS	10
TESTING INSTRUMENT	9
MEASURING TOOL	8
SURVEYING ACCESSORY	7
SURVEYING / LASER INSTRUMENT	6
GNSS ACCESSORY	5
STAFF	4
POLE	3
PRISM	2
TRIPOD	1

Introduction

Classificate by 3 main factors.

There are 3 main factors why people wear hard hats. In this catalog, these 3 symbols are displayed.



Developed to prevent/reduce risks involving fragments or falling objects.



Developed to reduce impact on a head from falling down.
(Impact absorption liner inside)



Developed to prevent risks involving head electrification. (under 7,000V)

Quality Control

Quality of hard hat is controlled by several machines which proof as world standard.

✓ CHECK

Penetration resistance Inspection



1. Set the hard hat on dummy head.
2. Drop 3kg spear shape weight from 1m height.
3. It is OK if tip of spear shape weight did not touch dummy head.

✓ CHECK

Impact resistance Inspection



1. Set the hard hat on dummy head.
2. Drop 5kg hemisphere shape weight from 1m height.
3. It is OK if impact power to dummy head is under 5kN.

Hard Hat

Venty

GOOD VENTILATION

Feel fresh by venthole.



White & Black



White & Clear



White & Green



White & Yellow



Yellow & Black



Blue & Black



Navy & Gray

► FEATURES

- Enhanced ventilation, supreme fitting
- Air holes ensure proper airflow in the helmet
- Deodorant processed inner material and chin adjuster
- Scratch-resistant peak by special coating
- Shutting down 99.9% of ultraviolet rays
- Antistatic proceed shell resistant from dust

► SPECIFICATIONS

- Head size : 53cm ~ 62cm
- Weight : 440g
- Material : ABS Resin / Polycarbonate

✓ CHECK

Venthole

Venthole allow air to circulate.
It brings freshness and coolness.



NO.390F-OT



PRODUCT NAME	MODEL	PKG QTY	MOQ	CODE NO.	C/O
Venty	390F-OT	10	10	218185	JP

NEW **Hard Hat**
1840S-FZ

FOR SURVEYOR

Soft cover protect surroundings in narrow place.

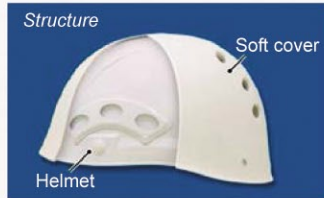

► **FEATURES**

- Soft cover prevents damaging surroundings while interior work
- Convenient in narrow space without brim
- Cool by big air hole

► **SPECIFICATIONS**

Head size : 53cm ~ 62cm
Weight : 460g
Material : ABS Resin / PE

1840S-FZ



PRODUCT NAME	MODEL	PKG QTY	MOQ	CODE NO.	C/O
Hard Hat	1840S-FZ	10	10	219373	JP

Hard Hat

NO.360

LIGHTWEIGHT AND FRESHNESS

Lightweight helmet No.360 brings freshness and good fit.



► **FEATURES**

- Ultralight with ventiholes
- Deep and firm fit, with a quick-release buckled chin strap
- Antistatic proceed shell restant from dust
- No.360F has a styrol liner

► **SPECIFICATIONS**

Head size : 53cm ~ 61cm
Weight : 333g (NO.360)
350g (NO.360F)
Material : ABS Resin

NO.360



NO.360F



PRODUCT NAME	MODEL	PKG QTY	MOQ	CODE NO.	C/O
Hard Hat	NO.360	10	10	214150	JP
Hard Hat	NO.360F	10	10	214151	JP

Hard Hat

NO.110

NO BRIM

There is no brim, it doesn't disturb your surveying.



► **FEATURES**

- Light weight
- fit-comfortable model
- Antistatic proceed shell restant from dust
- No.110F has a styrol liner

► **SPECIFICATIONS**

Head size : 53cm ~ 64cm
Weight : 364g (NO.110)
381g (NO.110F)
Material : ABS Resin
Color : White / Yellow / Cream / Green / Pale Yellow / Blue / Orange / Red / Navy / Aqua

NO.110



NO.110F



PRODUCT NAME	MODEL	PKG QTY	MOQ	CODE NO.	C/O
Hard Hat	NO.110	10	10	214125	JP
Hard Hat	NO.110F	10	10	214126	JP

Fan for Hard Hat

N16-26

FOR YOUR COMFORTABLE WORK

Just mounting on your hard hat bring your comfortable work.



Hard hat is option

► **SPECIFICATIONS**

Size : 80 x 128 x 45mm
Weight : 91g
Material : ABS
Wind speed : 6.2m/s (9V)

► **STANDARD ACCESSORIES**

- Cable
- Battery charger
- Rechargeable battery

CHECK

HUMIDITY DOWN 28%

Just starting up reduce humidity 28% down inside hard hat.



PRODUCT NAME	MODEL	PKG QTY	MOQ	CODE NO.	C/O
Fan for Hard Hat	N16-26	1	10	221428	JP

TRIPOD 1
PRISM 2
POLE 3
STAFF 4
GNSS ACCESSORY 5
SURVEIVING / LASER INSTRUMENT 6
SURVEIVING ACCESSORY 7
MEASURING TOOL 8
TESTING INSTRUMENT 9
SECURITY GOODS 10

NEW Safety Vest - Short type

5920010 series

HIGH WORK EFFICIENCY
Short vest doesn't interrupt your work.

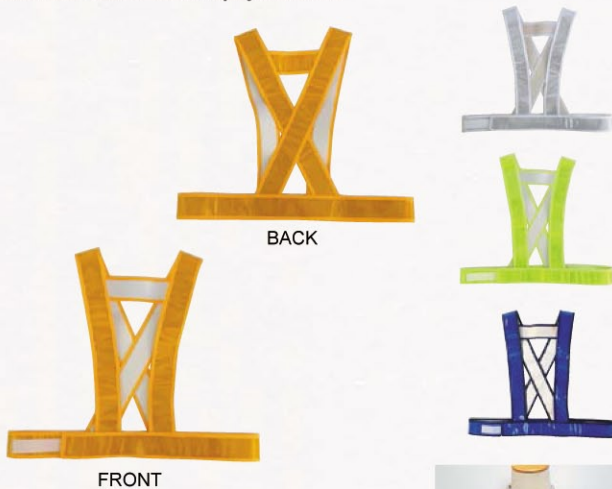

- **SPECIFICATIONS**
- Material : Polyvinyl chloride (PVC)
 - Size Length : 40cm
 - Waist : 100 ~ 120cm
 - Reflective tape : 50mm



PRODUCT NAME	MODEL	PKG QTY	MOQ	CODE NO.	C/O
Safety Vest Short type - Gold	5920010	10	10	222201	CN
Safety Vest Short type - White	5920012	10	10	222202	CN
Safety Vest Short type - Yellow	5920015	10	10	222203	CN
Safety Vest Short type - Blue	5920014	10	10	222204	CN

Safety Vest

NO.7046 NO.63

FOR NIGHT WORK
LED light and reflective vest save your life from traffic accident.

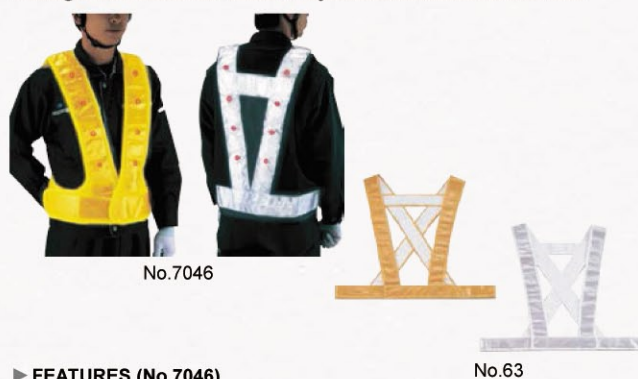

- **FEATURES (No.7046)**
- LED flashing
 - LED light saves you from danger in the dark
 - Combination of reflection material & LED light

► **SPECIFICATIONS**

Model	NO.7046	NO.63
Power	AA battery x 2pcs	-
Operating time	approx. 30 hours	-
LED light	16 pcs (red color)	-
Adjustable waist	85 ~ 120cm	85 ~ 120cm
Weight	328g	160g
Color	Yellow / Yellow, Navy / White, Navy / Lime	Yellow / Yellow, Navy / White

PRODUCT NAME	MODEL	PKG QTY	MOQ	CODE NO.	C/O
LED Safety Vest	NO.7046	6	12	-	JP
Safety Vest	NO.63	6	12	-	JP

NEW Mesh Safety Vest

3000000 series

SIZE ADJUSTABLE
Length and waist adjustable for a great fit.



- **FEATURES**
- 4 pockets (located on the chest and inside of the vest)
 - Adjustable size

- **SPECIFICATIONS**
- Size Length : 50, 53, 57, 60cm
 - Waist : 94 ~ 130cm
 - Reflective tape : 6cm



PRODUCT NAME	MODEL	PKG QTY	MOQ	CODE NO.	C/O
Safety Vest - Navy & Yellow line	3001000	10	10	221698	CN
Safety Vest - Navy & White line	3002000	10	10	221699	CN
Safety Vest - Yellow & Yellow line	3002001	10	10	221700	CN

NEW LED Safety Vest

Light Vest

RECHARGEABLE
LED light and reflective vest save your life from traffic accident.



- **FEATURES**
- LED flashing
 - LED light saves you from danger in the dark
 - Combination of reflection material & LED light

► **SPECIFICATIONS**

Power	: Rechargeable battery
Charge time	: approx. 8 hours
Operating time	: approx. 8 hours
LED light	: 0.5W x 6
Material	: Polyester and PVC
Waist	: approx. 100cm

► **STANDARD ACCESSORIES**

- Charger (AC / USB)

PRODUCT NAME	MODEL	PKG QTY	MOQ	CODE NO.	C/O
LED Safety Vest - Navy & White	Light Vest1	10	10	219704	CN
LED Safety Vest - Orange & Yellow	Light Vest2	10	10	219707	CN

Safety Full Body Harness

FGH-7

DISTRIBUTE FALLING IMPACT

Full-harness distributes the impact by falling.



BACK

✓ CHECK

Full body harness can be used for prolonged positioning. It distributes physical load or falling impact.

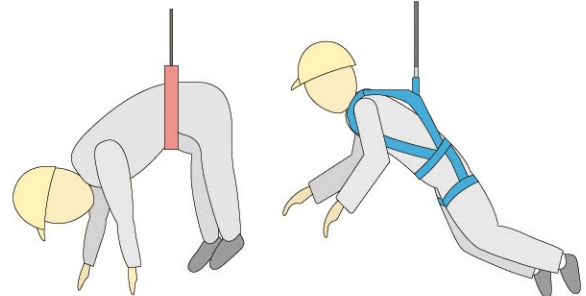

WAIST BELT HARNESS

FULL BODY HARNESS

✓ CHECK

Japanese Standard Passed

In Japan, the user is obliged to wear the safety harness or belt to protect their life. Japanese ministry of health, labour and welfare set the strict standard relevant to shape, withstand load, parts and so on. This product passed that standard.

► SPECIFICATIONS

Size : 1,220mm
Weight : 2,525g
Lanyard : 1,650mm

PRODUCT NAME	MODEL	PKG QTY	MOQ	CODE NO.	C/O
Safety Harness	FGH-7	4	8	-	JP

Safety Belt (Single Rope)

GH-666

WORK FREE FROM ANXIETY

GH-666 is necessary for high place work.



► FEATURES

- Big hook
- 50mm width belt
- Japanese standard passed

► SPECIFICATIONS

Size : 1,220mm
Weight : 890g
Belt width : 50mm
Waist size : up to 1,100mm

PRODUCT NAME	MODEL	PKG QTY	MOQ	CODE NO.	C/O
Safety Belt	GH-666	5	20	-	JP

Safety Belt (Retractable Single Rope)

RU-301

DETACHABLE & RETRACTABLE

It's compact and easy to store.



► FEATURES

- Retractable rope
- Big hook
- 50mm width belt
- Japanese standard passed

► SPECIFICATIONS

Size : 1,220mm
Weight : 1,190g
Belt width : 50mm
Waist size : up to 1,100mm



PRODUCT NAME	MODEL	PKG QTY	MOQ	CODE NO.	C/O
Safety Belt	RU-301	5	20	-	JP

TRIPOD 1
PRISM 2
POLE 3
STAFF 4
GNSS ACCESSORY 5
SURVEYING / LASER INSTRUMENT 6
SURVEYING ACCESSORY 7
MEASURING TOOL 8
TESTING INSTRUMENT 9
SECURITY GOODS 10

NEW Artificial Leather Gloves
PU Smart

FULL PALM TOUCHSCREEN COMPATIBILITY
Superior dexterity and sensitivity.



▶ FEATURES

- Washable

▶ SPECIFICATIONS

Material : Polyurethane(palm), Polyester
Color : Black
Size : M, L, LL

PRODUCT NAME	MODEL	PKG QTY	MOQ	CODE NO.	C/O
PU Smart - L size	#2966	10	10	221685	CN

NEW Artificial Leather Gloves
PU Master / PU Doctor

SOFT & COMFORTABLE
Stretch and washable fabric.



▶ SPECIFICATIONS

Model	PU Master #2974	PU Doctor #2970
Thickness	0.5mm	0.7mm
Material	Polyurethane(palm), Polyester	Polyurethane(palm), Polyester
Liner	Nylon	Nylon
Color	Yellow	Yellow
Size	M, L, LL	M, L, LL

PRODUCT NAME	MODEL	PKG QTY	MOQ	CODE NO.	C/O
PU Master - L size	#2974	10	10	216482	CN
PU Doctor - L size	#2970	10	10	216483	CN

NEW Ventless Goggles
No.1220

ABLE TO USE OVER GLASSES
Perfect for asbestos work with anti-fog lens without holes.



▶ SPECIFICATIONS

Lens thickness : 0.8mm
Material Frame : PVC
Lens : Polycarbonate
Weight : approx. 60g

PRODUCT NAME	MODEL	PKG QTY	MOQ	CODE NO.	C/O
Ventless Goggles	No. 1220	12	12	216434	JP

NEW Safety Shoes
Magical Forester

FOR FORESTER AND HUNTER
Easy to put on / take off by durable fastener.



▶ FEATURES

- U shape 2.2mm steel spike pin
- FRP toe and rubber protector
- Right weight

▶ SPECIFICATIONS

Size : 24.5 ~ 28.0cm, EEE
Weight : approx. 270g (26cm, one shoe)
Material : Leather + Artificial leather
Sole : Rubber + Steel spike pin

PRODUCT NAME	MODEL	PKG QTY	MOQ	CODE NO.	C/O
Magical Forester	#005	1	1	222188	CN

NEW Safety Shoes
7500 series / LS411

STEEL-TOE
Steel-toe protects the foot from falling objects or compression.



7533



7544



LS411

▶ SPECIFICATIONS

Model	7533 / 7544	LS411
Standard	JIS T 8101 SEF	JSAA B
Toecap	Wide ACM Resin	ACM Resin
Upper	Soft Embossing Cow Leather	Synthetic Leather + Mesh
Outsole	PUDD	EVA + NBR Rubber
Weight	1,025g / 1,005g (26.0cm pair)	600g (26.0cm pair)
Size (EEE)	23.5 ~ 28.0cm	24.0 ~ 27.0, 28.0, 29.0cm

PRODUCT NAME	MODEL	PKG QTY	MOQ	CODE NO.	C/O
Safety Shoes - Boots with Shoelace	7533	1	1	122263	JP
Safety Shoes - Boots	7544	1	1	122264	JP
Safety Shoes - Sneaker	LS411	1	1	220732	CN

NEW **Air Conditioned Working Wear**
BR series

KEEP COOL

This wear keep you cool in stuffy environments.

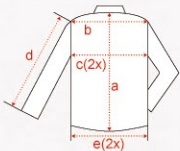

Size / cm	a	b	c	d	e	e(max)
M	64	50	116	54	77	108
L	66	52	120	56	82	113
LL(2L)	68	54	124	58	87	118
XL(3L)	70	56	132	60	92	123

PRODUCT NAME	MODEL	PKG QTY	MOQ	CODE NO	C/O
Safety Harness compatibility type - Blue	BR-588-B	1	1	222232	JP
Safety Harness compatibility type - Green	BR-588-G	1	1	222233	JP
Simple type - Blue	BR-666-B	1	1	222234	JP
Simple type - Green	BR-666-G	1	1	222235	JP
Li-ion Battery	Battery	1	1	222236	JP
Replacement Fan x 2	Fan	1	1	222237	JP

CHECK



Safety harness compatibility (BR-588)
Fastener on the back and loops on right / left chest for safety harness belt and hook.

CHECK



Fan removable easily
Removable fan make this jacket washable, and patch from inside will make it standard jacket.

SPECIFICATIONS

Fan size : 102 x 40mm 90g
Wind power : Max. 1.0m/min, 4 levels
Operating time : approx. 10h
Material : Cotton & Polyester

STANDARD ACCESSORIES

- Jacket
- Patch x 2
- Li-ion battery
- Charger
- Cable
- Fan x 2



NEW **LED Head Light**
GLANZ

IN DARKNESS OR NIGHT

You can find favorite one from various models.



MF9100HR

FEATURES

- High Power → Low Power → Blinking
- Focusable
- Tilting
- Chargeable with wearing

STANDARD ACCESSORIES

- Fabric band
- Fixing clip x 2pcs
- Rechargeable battery
- Charger



M-935HR

FEATURES

- High - middle - low, Wide / Spot
- Built-in USB cable
- Battery indicator
- Tilting

STANDARD ACCESSORIES

- Fabric band
- Rechargeable battery



MF3100H

FEATURES

- High Power → Low Power → Blinking
- Focusable
- Tilting

STANDARD ACCESSORIES

- Fabric band
- Batteries



RDH-04

FEATURES

- Focusable
- Blinking mode
- Modulated light

STANDARD ACCESSORIES

- Fabric band
- Batteries

SPECIFICATIONS

PRODUCT NAME	MODEL	PKG QTY	MOQ	CODE NO.	C/O
LED Head Light	MF9100R	1	10	221104	CN
LED Head Light	MF3100H	1	10	221103	CN
LED Head Light	M-935HR	1	10	221623	CN
LED Head Light	RDH-04	1	10	220917	CN

Model	MF9100HR	MF3100H	M-935HR	RDH-04
Brightness(lumen)	1,010	800	350	250
Irradiation distance	approx. 600m	approx. 600m	-	approx. 200m
Water & dust resistance	IP66	IP65	IPX4	IP65
Working time(High)	approx. 6h	approx. 8h	approx. 6h	approx. 10h
Battery	Li-ion battery	AA x 4	Li-ion battery	AA x 3
Size	63 x 62 x 56 mm	63 x 62 x 56 mm	40 x 45 x 57 mm	60 x 34 x 40 mm
Weight	approx.180 g	approx.180 g	approx.99 g	approx. 80 g

TRIPOD 1
PRISM 2
POLE 3
STAFF 4
GNSS ACCESSORY 5
SURVEIVING / LASER INSTRUMENT 6
SURVEIVING ACCESSORY 7
MEASURING TOOL 8
TESTING INSTRUMENT 9
SECURITY GOODS 10

LED Torch

NIGHT SAFARI

ANY WHERE, ANY SITUATION

NIGHT SAFARI have tough body and high water resistance.



NSA-G1



NSA-G2



NSA-G3

► FEATURES

- Waterproof & dust-proof (IP67)
- Robust body (crack-proof)
- LED light is made by Cree Inc. (USA)

► SPECIFICATIONS

Model	NSA-G1	NSA-G2	NSA-G3
Brightness	90lm	150lm	250lm
Max. distance	approx. 100m	approx. 150m	approx. 250m
Operating time	2.5 hours	8 hours	6 hours
Power	AA battery x 1	AA battery x 2	C battery x 2
Dimensions	25 φ x 100mm	30.5 φ x 161mm	46.4 φ x 186mm
Weight	46g	109g	252g

PRODUCT NAME	MODEL	PKG QTY	MOQ	CODE NO.	C/O
LED Torch	NSA-G1	1	6	220417	CN
LED Torch	NSA-G2	1	10	220418	CN
LED Torch	NSA-G3	1	5	220419	CN

USB LED Torch

RDT series

USB CHARGE

It's eco friendly by rechargeable battery and high power.



RDT-01R



RDT-02R



USB Charge

► FEATURES

- Micro USB charge
- It can be used as battery for mobile (01R only)
- IP64
- Focussable and diffusible
- High → Mid → Low → Blinking → OFF

► SPECIFICATIONS

Model	RDT-01R	RDT-02R
Brightness	350 lumen	200 lumen
Operating time	5 hours(high)	3 hours(high)
Size	43 φ x 136mm	30 φ x 82mm
Weight	approx. 200g	approx. 80g

PRODUCT NAME	MODEL	PKG QTY	MOQ	CODE NO.	C/O
LED Torch	RDT-01R	1	5	222189	CN
LED Torch	RDT-02R	1	5	222190	CN



Inspection Camera

Snake scope

VARIOUS CAMERA PROBES AVAILABLE

The camera type is selectable according to objects or circumstance.



SS-11



SS-12

► STANDARD ACCESSORIES

- Camera probe(SS-V8)
- Video cable (SS-11 only)
- Attachment set
 - Mirror
 - Magnet
 - Double hook
 - Single hook
- Case

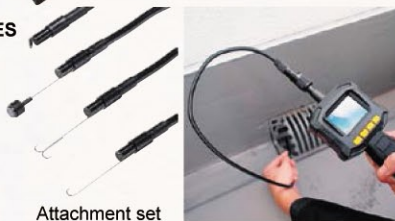

Attachment set

PRODUCT NAME	MODEL	PKG QTY	MOQ	CODE NO.	C/O
Snake scope - Video output	SS-11	5	1	220960	CN
Snake scope - Video record	SS-12	5	1	220961	CN
Probe - Interlock type 8 x 980mm	SS-V8	1	1	220962	CN
Probe - Elastic type 4.5 x 980mm	SS-V45	1	1	220963	CN
Probe - Interlock type 9 x 5000mm	SSVC-9005	1	1	220965	CN
Probe - Elastic type 4.5 x 5000mm	SSVC-4505	1	1	220964	CN
Probe - Interlock type 9 x 980mm - Dual	SS-D9	1	1	220966	CN
Probe - Interlock type 5.8 x 1200mm - Remote	SS-R58	1	1	222356	CN

► SPECIFICATIONS

Display	: 2.4 inch / 640 x 480 pixel
Focus	: 30 ~ 60mm
Memory (SS-12)	: microSD card 1 ~ 32GB (option)
Power	: AA batteries x 4
Operating time	: approx. 6h
Operating temperature	: -10 ~ + 50°C / 15 ~ 85%RH
Storage temperature	: -10 ~ + 70°C / 15 ~ 85%RH
Size (Main unit)	: 88 x 259 x 45mm
Size (Package)	: 320 x 210 x 70mm
Weight (Main unit)	: approx. 400g (incl. batteries)
Weight (Package)	: approx. 1,010g

+1 OPTION

PROBES IP 67

- Interlock type (Hard) for attic inspection etc.
- Elastic type (Soft) for plumbing etc.

*SS-V8 and SSVC-9005 come with attachment set (Double hook, Single hook, Magnet, Mirror, Rubber rings x 2)

<p>SS-V8 φ 8mm x 98cm</p>	<p>SSVC-9005 φ 9mm x 5m</p>	<p>SS-V45 φ 4.5mm x 98cm</p>
<p>SS-R58 Remote head φ 5.8mm x 120cm</p>	<p>SS-D9 Dual cameras φ 9mm x 98cm</p>	<p>SSVC-4505 φ 4.5mm x 5cm</p>

Safety Cone

SCOTCH CONE

HIGH DURABILITY

This is necessary for the construction.



SCR

SCYR

SCG



SPECIFICATIONS

Height : 700mm
Base : 385 x 385mm
Weight : 880g



CU-2 (2kg)

PRODUCT NAME	MODEL	PKG QTY	MOQ	CODE NO.	C/O
Scotch Cone Red	SCR	1	10	122102	CN
Scotch Cone Yellow	SCYR	1	10	122086	CN
Scotch Cone Green	SCG	1	10	122087	CN
Weight	CU-2	1	10	122103	CN
Cone Bar 34mm φ/2m	CB3420	1	10	122106	CN

NEW PVC Soft Safety Cone

3110730 series

DRIVE OVER IT AND IT WILL BOUNCE BACK

Sturdy and strong visibility with two reflective stripes, but not too heavy.



SPECIFICATIONS

Material : Polyvinyl chloride (PVC)
Size : 700 x 355 x 355mm
Weight : 3.4kg



+1 OPTION

Solar Smart Marker (Flashing light)

Able to pile up PVC cone with this light on
LED : Red x 3, blink(100 / 1mins)
Size : 47.5 x φ60mm
No sunshine : Light over 90 hours



PRODUCT NAME	MODEL	PKG QTY	MOQ	CODE NO.	C/O
PVC Safety Cone Red	3110732	1	1	221858	CN
PVC Safety Cone Green	3110733	1	1	221859	CN
PVC Safety Cone Yellow	3110734	1	1	221860	CN
PVC Safety Cone Blue	3110735	1	1	221861	CN
Flashing Light - Solar Smart Marker	SSM	1	1	221862	CN

Folding Safety Cone

FOLDING SAFETY CONE

EASY TO CARRY

It's for division and traffic control.



FEATURES

- Compact to store
- High visibility by reflective surface

SPECIFICATIONS

Model	8201033	8201021	8201025
Size	19 x 19 x 33cm	24.5 x 24.5 x 41cm	29.5 x 29.5 x 62cm
Weight	0.275kg	0.46kg	0.70kg

PRODUCT NAME	MODEL	PKG QTY	MOQ	CODE NO.	C/O
Folding Cone 30cm	8201033	10	10	222151	CN
Folding Cone 41cm	8201021	10	10	221113	CN
Folding Cone 62cm	8201025	10	10	221114	CN
Weight 41cm	8201023	10	10	221115	CN
Weight 62cm	8201026	10	10	221116	CN

Reflective Caution Rope

104HI

HIGH VISIBILITY IN DARK

104HI is weaved reflective material to get high visibility.



SPECIFICATIONS

Brightness : 300 ~ 330cd
Size : φ12mm x 100m

PRODUCT NAME	MODEL	PKG QTY	MOQ	CODE NO.	C/O
Reflective Caution Rope	104HI	-	10	221179	JP
Reflective Caution Rope	104HI-R	-	10	221180	JP
Reflective Caution Rope	104HI-G	-	10	221181	JP

Portable Barricade Tape

CONE BAR TAPE

EVER-CHANGING

It's ever-changing for your favorite layout.



Junction Adapter
JCT-K



SPECIFICATIONS

Length : 0.3 ~ 4m
Width : 50mm

PRODUCT NAME	MODEL	PKG QTY	MOQ	CODE NO.	C/O
Cone Bar Tape	JCT-400	1	10	221118	CN
Junction Adapter	JCT-K	1	10	221119	CN



Power to Create

**We, Myzox create the products
which are used all over the world.**

myzox Myzox Co., Ltd. 401 Yamagoe, Nagakute, Aichi 480-1111 Japan
TEL : +81-561-64-2210 FAX : +81-561-63-7770 E-mail : international@myzox.co.jp

published date : July 21, 2018

* Informations on this catalog are subject to change without notice

myzox

Your local authorized Myzox dealer is :

Power to Create Myzox Japan

